



# TOYO LED ELECTRONICS LIMITED

Room 1610, Hong Kong Plaza, 188 Connaught Road West, Hong Kong.

Tel : (852) 2540 7288  
http://www.toyo-led.com

Fax : (852) 2517 1797  
E-mail : sales@toyo-led.com



**P/N: TY-L1206UY1(0.80)**

1206 Package 3.2\*1.6mm Surface Mount LEDs Series

# SPECIFICATION FOR CUSTOMER APPROVAL

## P/N: TY-L1206UY1(0.80)

DATE : January 12, 2014

PREPARED BY : Yanguoliang

CONFIRMED BY :

**PLEASE CONFIRM & SIGN BACK THIS SHEET TO US**

**CUSTOMER:** \_\_\_\_\_

(COMPANY CHOP)

**APPROVAL BY:** \_\_\_\_\_

(SIGNATURE)



# TOYO LED ELECTRONICS LIMITED

Room 1610, Hong Kong Plaza, 188 Connaught Road West, Hong Kong.

Tel : (852) 2540 7288  
http://www.toyo-led.com

Fax : (852) 2517 1797  
E-mail : sales@toyo-led.com



**P/N: TY-L1206UY1(0.80)**

1206 Package 3.2\*1.6mm Surface Mount LEDs Series

## ✧ Features:

- 3.2\*1.6\*0.8 mm
- Mono-color type
- Soldering methods :All SMT assembly methods
- Comply ROHS standard

## ✧ Description

The Yellow source color devices are made with **AlGaInP** on sapphire Light Emitting Diode.

## ✧ Application

- Optical indicator
- Indicator and backlighting in telephone and fax
- Flat backlight for LCD, switch and symbol
- Light pipe application
- General use

## ✧ Package Dimensions

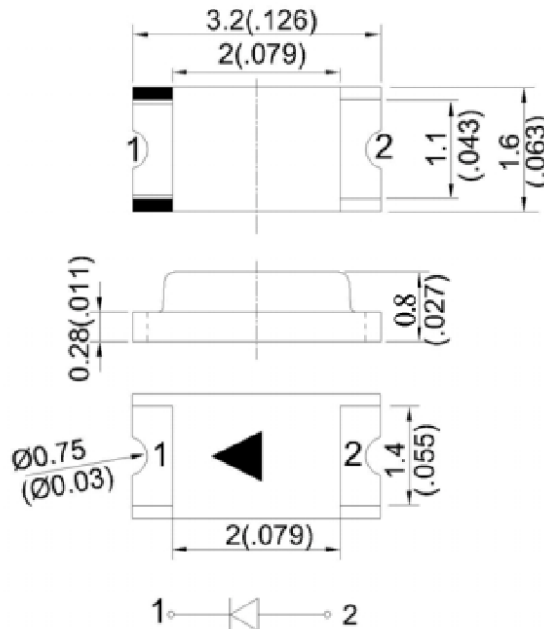

## NOTES:

1. All dimensions are in millimeter[unit];
2. Tolerance is  $\pm 0.1$ mm(0.004") unless other specified;
3. Specifications are subject to change without notice.



# TOYO LED ELECTRONICS LIMITED

Room 1610, Hong Kong Plaza, 188 Connaught Road West, Hong Kong.

Tel : (852) 2540 7288  
http://www.toyo-led.com

Fax : (852) 2517 1797  
E-mail : sales@toyo-led.com



## P/N: TY-L1206UY1(0.80)

1206 Package 3.2\*1.6mm Surface Mount LEDs Series

Part No.	Emitted Color	Lens Color	Chip Material
TY-L1206UY1(0.80)	Yellow	Water Clear	AlGaInP

### ✧ Absolute Maximum Ratings(Ta=25°C)

Item	Symbol	Maximum	Unit
Power Dissipation	PD	75	mW
Continuous Forward Current	I <sub>Fmax</sub>	30	mA
Peak Forward Current(1/10 Duty Cycle 0.1ms Pulse Width)	I <sub>FP</sub>	140	mA
Reverse Voltage	V <sub>R</sub>	5	V
Operating Temperature Range	T <sub>opr</sub>	-40 to+85	°C
Storage Temperature Range	T <sub>stg</sub>	-40 to+85	°C
Lead Solder Temperature	Tsol	260 °C for 3 seconds	

### ✧ Electrical/Optical Characteristics(Ta=25°C)

Item	Symbol	Condition	Min.	Typ.	Max	Unit
Forward Voltage	V <sub>F</sub>	I <sub>F</sub> =20mA	1.8	2.0	---	V
Luminous Intensity	I <sub>v</sub>	I <sub>F</sub> =20mA	90	--	140	mcd
Wavelength	λ	I <sub>F</sub> =20mA	587	591	--	nm
Viewing Angle	2θ <sub>1/2</sub>	I <sub>F</sub> =20mA	--	120	--	Deg
Reverse Current	I <sub>R</sub>	V <sub>R</sub> =5V	--	--	10	uA



# TOYO LED ELECTRONICS LIMITED

Room 1610, Hong Kong Plaza, 188 Connaught Road West, Hong Kong.

Tel : (852) 2540 7288  
 http://www.toyo-led.com

Fax : (852) 2517 1797  
 E-mail : sales@toyo-led.com



**P/N: TY-L1206UY1(0.80)**

1206 Package 3.2\*1.6mm Surface Mount LEDs Series

## ◇ Typical Electro-Optical Characteristics Curves

Forward Current Vs. Forward Voltage

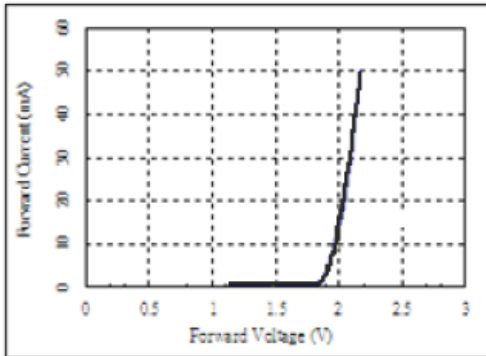

Relative Intensity VS Wavelength  
 Ta=25 °C

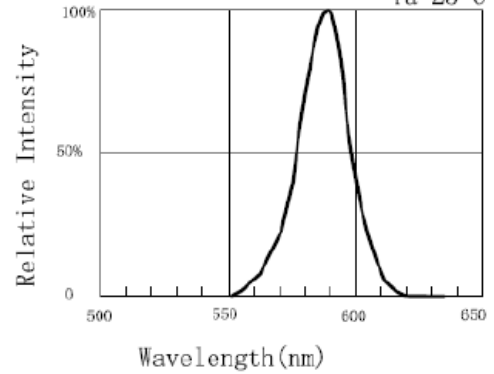

Forward Current VS  
 Ambient Temperature

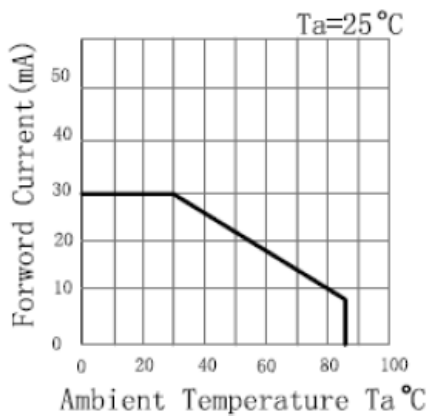

Forward Current Vs.  
 Relative Luminosity

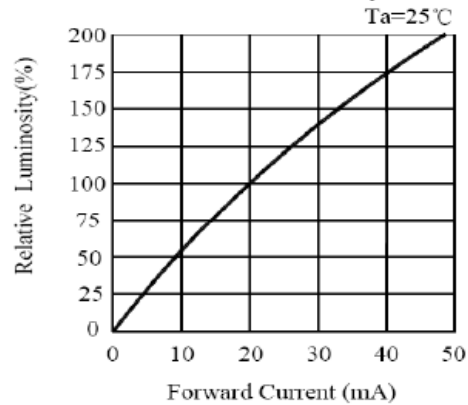

Relative Luminosity Vs.  
 Ambient Temperature

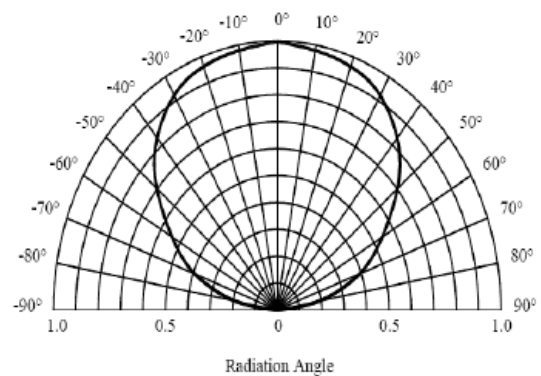
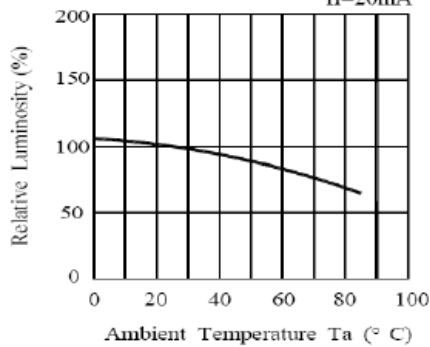



# TOYO LED ELECTRONICS LIMITED

Room 1610, Hong Kong Plaza, 188 Connaught Road West, Hong Kong.  
 Tel : (852) 2540 7288 Fax : (852) 2517 1797  
 http://www.toyo-led.com E-mail : sales@toyo-led.com



**P/N: TY-L1206UY1(0.80)**

1206 Package 3.2\*1.6mm Surface Mount LEDs Series

## ◇ Reliability Test Items And Conditions

NO.	Item	Test Condition	Test Hr/cycle/time	Sample Q'ty	Ac/Re
1	Reflow	TEMP:260±5°C; Min.5Sec	6 min	22pcs	0/1
2	Temperature Cycle	H:+90°C 30mins To(5mins) L:-30°C 30mins	300 cycles	22pcs	0/1
3	Thermal Shock	H:+100°C 20mins To(5mins) L:-40°C 20mins	300 cycles	22pcs	0/1
4	High Temperature Storage	TEMP:+100°C	1000hrs	22pcs	0/1
5	Low Temperature Storage	TEMP:-30°C	1000hrs	22pcs	0/1
6	DC Operating Life	IF=20MA	1000hrs	22pcs	0/1
7	High Temperature	65°C	240hrs	22pcs	0/1
8	High Humidity	R.H.= 85%		22pcs	0/1

## ◇ SMT Reflow Soldering Instructions

Number of reflow process shall be than 2 times and cooling  
 Process to normal temperature is required between first and second  
 soldering process

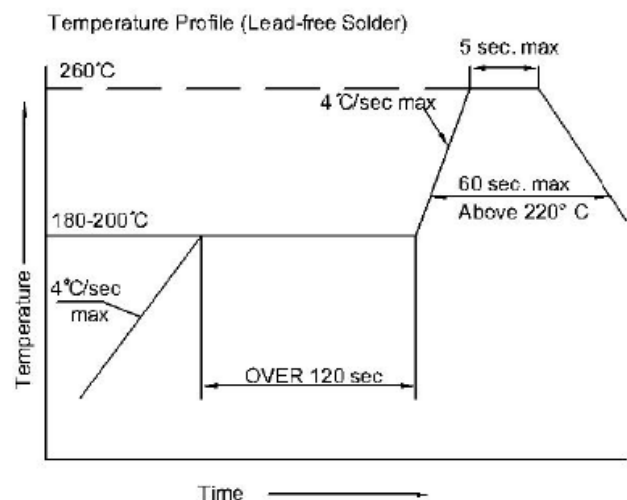
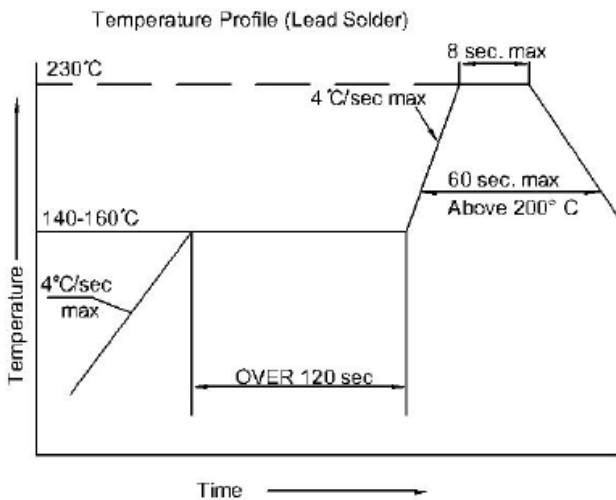



# TOYO LED ELECTRONICS LIMITED

Room 1610, Hong Kong Plaza, 188 Connaught Road West, Hong Kong.  
 Tel : (852) 2540 7288 Fax : (852) 2517 1797  
 http://www.toyo-led.com E-mail : sales@toyo-led.com



**P/N: TY-L1206UY1(0.80)**

1206 Package 3.2\*1.6mm Surface Mount LEDs Series

## ◇ Recommended Soldering Pad Dimensions

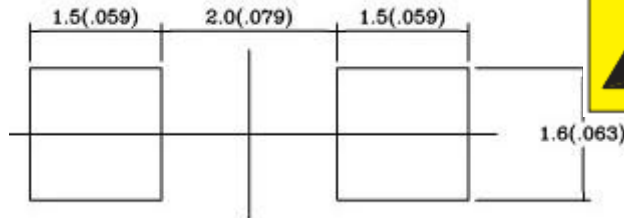

## ◇ Tape Specification: 3,000pcs

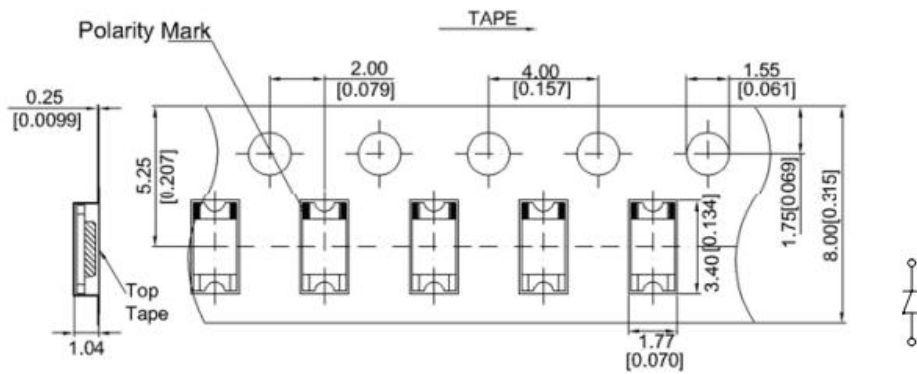
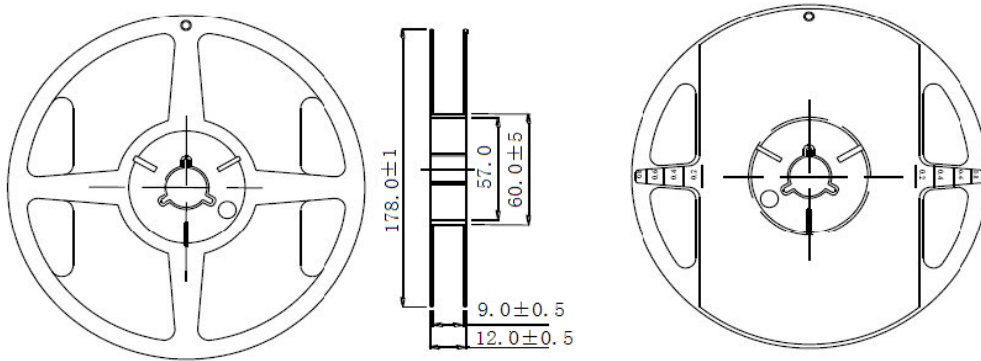

## ◇ Package Label

SMD LED	
PART NO: _____	QA Pass
LOT NO : _____	
Q' TY : _____	
VF : _____ IV : _____	
TC : _____ BIN: _____	Pb
DATE : _____	
TOYO LED ELECTRONICS LIMITED	
Website: <a href="http://www.toyo-led.com">http://www.toyo-led.com</a> E-mail: <a href="mailto:sales@toyo-led.com">sales@toyo-led.com</a>	



# TOYO LED ELECTRONICS LIMITED

Room 1610, Hong Kong Plaza, 188 Connaught Road West, Hong Kong.

Tel : (852) 2540 7288  
http://www.toyo-led.com

Fax : (852) 2517 1797  
E-mail : sales@toyo-led.com



**P/N: TY-L1206UY1(0.80)**

1206 Package 3.2\*1.6mm Surface Mount LEDs Series

## ❖ Package & Shipping Instructions

