



TOYO LED ELECTRONICS LIMITED

Room 1610, Hong Kong Plaza, 188 Connaught Road West, Hong Kong.

Tel : (852) 2540 7288
http://www.toyo-led.com

Fax : (852) 2517 1797
E-mail : sales@toyo-led.com



P/N: TY-L1206UG1(0.80)

1206 Package 3.2*1.6mm Surface Mount LEDs Series

✧ Features:

- 3.2*1.6*0.8 mm
- Mono-color type
- Soldering methods :All SMT assembly methods
- Comply ROHS standard

✧ Description

The Yellow Green source color devices are made with **AlGaInP** on sapphire Light Emitting Diode.

✧ Application

- Optical indicator
- Indicator and backlighting in telephone and fax
- Flat backlight for LCD, switch and symbol
- Light pipe application
- General use

✧ Package Dimensions

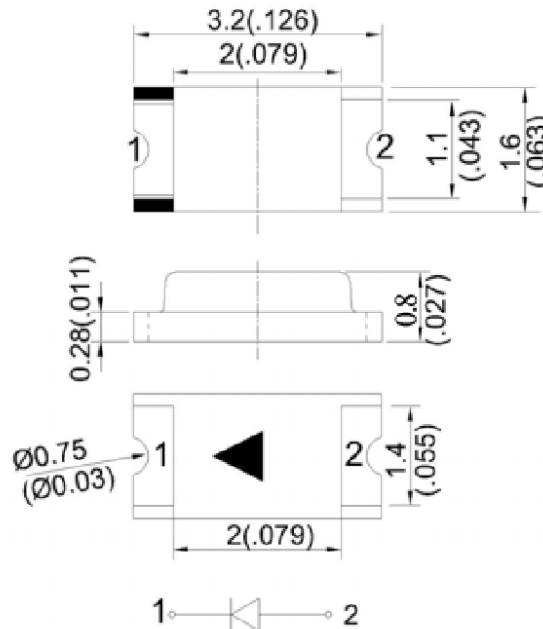

NOTES:

1. All dimensions are in millimeter[unit];
2. Tolerance is $\pm 0.1\text{mm}(0.004")$ unless other specified;
3. Specifications are subject to change without notice.



TOYO LED ELECTRONICS LIMITED

Room 1610, Hong Kong Plaza, 188 Connaught Road West, Hong Kong.

Tel : (852) 2540 7288
http://www.toyo-led.com

Fax : (852) 2517 1797
E-mail : sales@toyo-led.com



P/N: TY-L1206UG1(0.80)

1206 Package 3.2*1.6mm Surface Mount LEDs Series

Part No.	Emitted Color	Len's Color	Chip Material
TY-L1206UG1(0.80)	Yellow Green	Water clear	AlGaInP

✧ Absolute Maximum Ratings(Ta=25°C)

Item	Symbol	Maximum	Unit
Power Dissipation	PD	78	mW
Continuous Forward Current	I _{Fmax}	30	mA
Peak Forward Current(1/10 Duty Cycle 0.1ms Pulse Width)	I _{FP}	100	mA
Reverse Voltage	V _R	5	V
Operating Temperature Range	T _{opr}	-40 to+85	°C
Storage Temperature Range	T _{stg}	-40 to+85	°C
Lead Solder Temperature	Tsol	260 °C for 3 seconds	

✧ Electrical/Optical Characteristics(Ta=25°C)

Item	Symbol	Condition	Min.	Typ.	Max	Unit
Forward Voltage	V _F	I _F =20mA	1.8	2.0	2.3	V
Luminous Intensity	I _v	I _F =20mA	30	--	80	mcd
Wavelength	λ	I _F =20mA	565	570	575	nm
Viewing Angle	2θ _{1/2}	I _F =20mA	--	120	--	Deg
Reverse Current	I _R	V _R =5V	--	--	10	uA



TOYO LED ELECTRONICS LIMITED

Room 1610, Hong Kong Plaza, 188 Connaught Road West, Hong Kong.

Tel : (852) 2540 7288
<http://www.toyo-led.com>

Fax : (852) 2517 1797
 E-mail : sales@toyo-led.com



P/N: TY-L1206UG1(0.80)

1206 Package 3.2*1.6mm Surface Mount LEDs Series

◇ Typical Electro-Optical Characteristics Curves

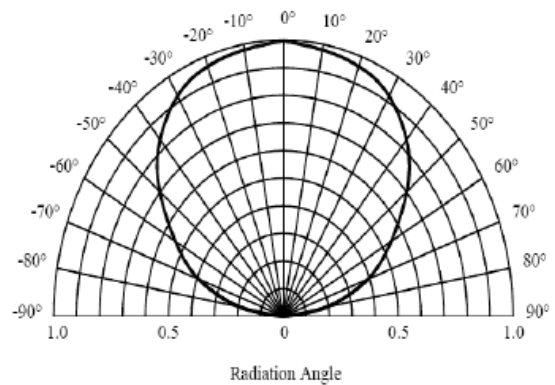
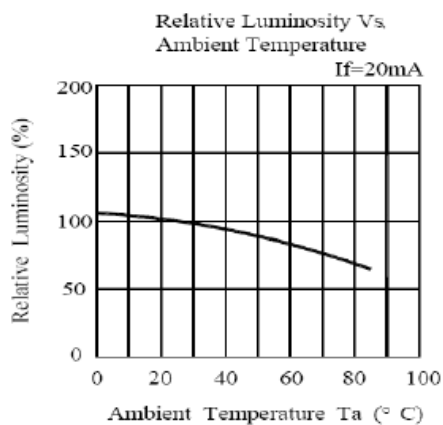
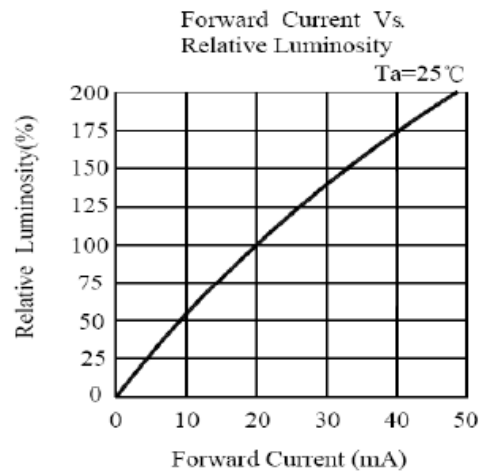
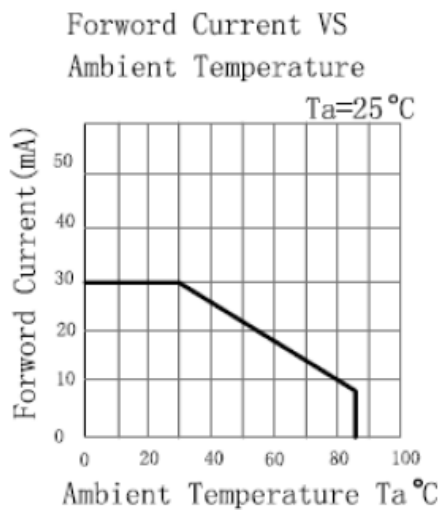
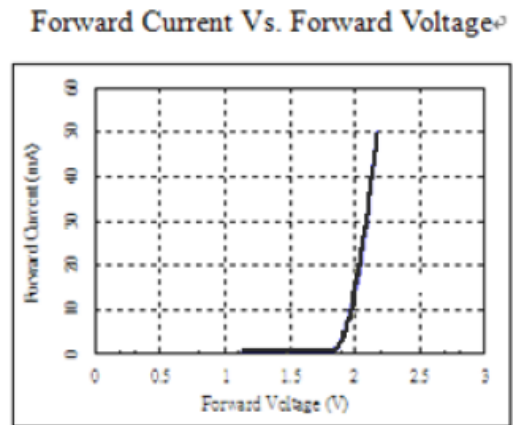
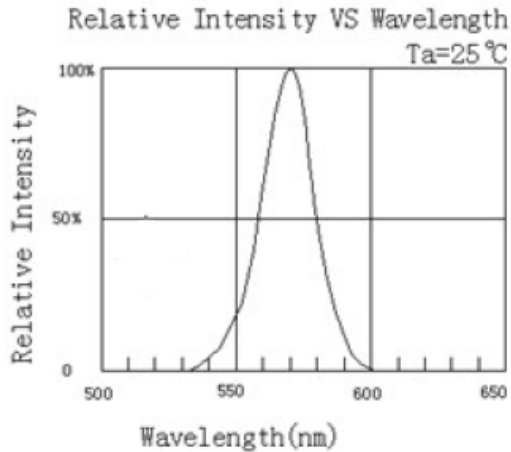



TOYO LED ELECTRONICS LIMITED

Room 1610, Hong Kong Plaza, 188 Connaught Road West, Hong Kong.
 Tel : (852) 2540 7288 Fax : (852) 2517 1797
 http://www.toyo-led.com E-mail : sales@toyo-led.com



P/N: TY-L1206UG1(0.80)

1206 Package 3.2*1.6mm Surface Mount LEDs Series

◇ Reliability Test Items And Conditions

NO.	Item	Test Condition	Test Hr/cycle/time	Sample Q'ty	Ac/Re
1	Reflow	TEMP:260±5°C; Min.5Sec	6 min	22pcs	0/1
2	Temperature Cycle	H:+90°C 30mins To(5mins) L:-30°C 30mins	300 cycles	22pcs	0/1
3	Thermal Shock	H:+100°C 20mins To(5mins) L:-40°C 20mins	300 cycles	22pcs	0/1
4	High Temperature Storage	TEMP:+100°C	1000hrs	22pcs	0/1
5	Low Temperature Storage	TEMP:-30°C	1000hrs	22pcs	0/1
6	DC Operating Life	IF=20MA	1000hrs	22pcs	0/1
7	High Temperature	65°C	240hrs	22pcs	0/1
8	High Humidity	R.H.= 85%		22pcs	0/1

◇ SMT Reflow Soldering Instructions

Number of reflow process shall be than 2 times and cooling
 Process to normal temperature is required between first and second
 soldering process

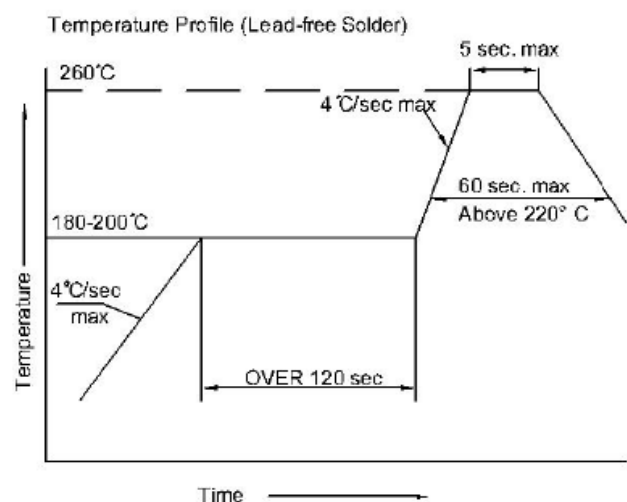
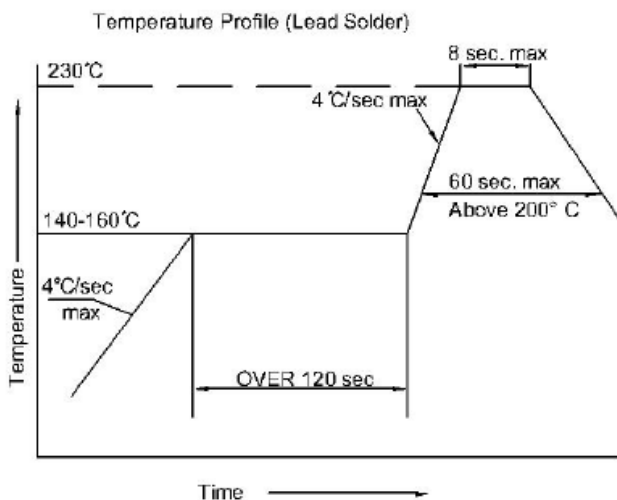



TOYO LED ELECTRONICS LIMITED

Room 1610, Hong Kong Plaza, 188 Connaught Road West, Hong Kong.
 Tel : (852) 2540 7288 Fax : (852) 2517 1797
 http://www.toyo-led.com E-mail : sales@toyo-led.com



P/N: TY-L1206UG1(0.80)

1206 Package 3.2*1.6mm Surface Mount LEDs Series

❖ **Recommended Soldering Pad Dimensions**

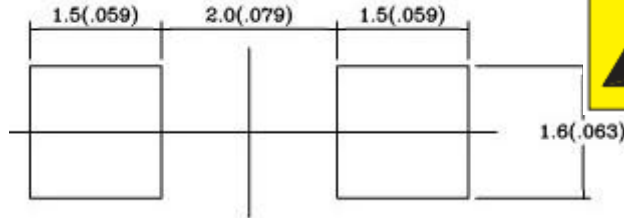

❖ **Tape Specification: 3,000pcs**

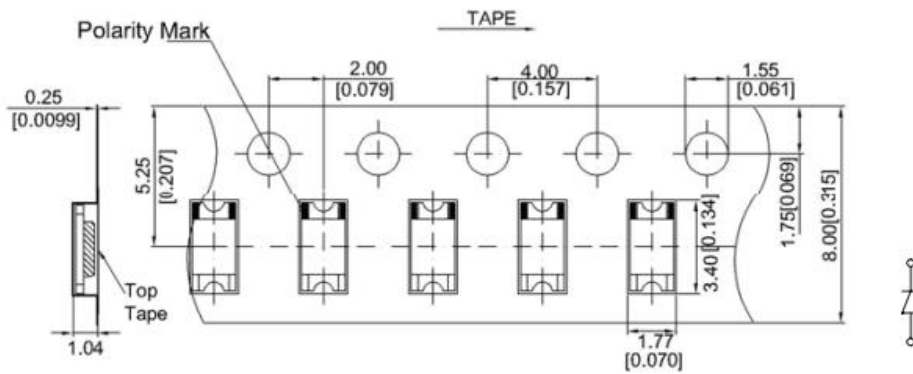
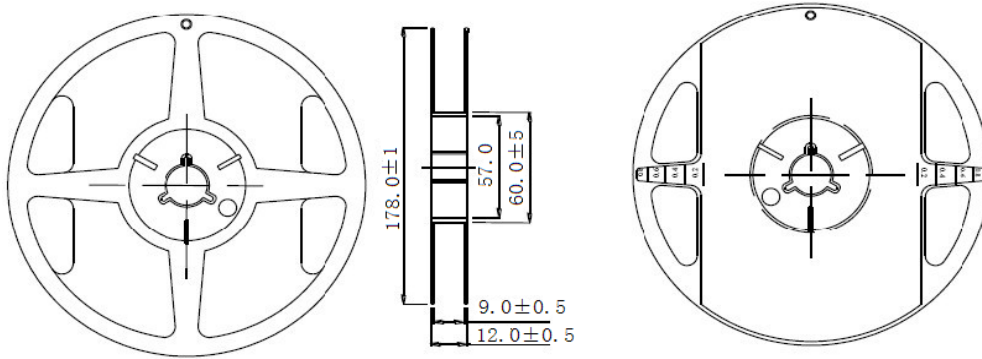

❖ **Package Label**

SMD LED	
PART NO: _____	QA Pass
LOT NO : _____	
Q' TY : _____	
VF : _____ IV : _____	Pb
TC : _____ BIN: _____	
DATE : _____	
TOYO LED ELECTRONICS LIMITED	
Website: http://www.toyo-led.com E-mail: sales@toyo-led.com	



TOYO LED ELECTRONICS LIMITED

Room 1610, Hong Kong Plaza, 188 Connaught Road West, Hong Kong.

Tel : (852) 2540 7288
http://www.toyo-led.com

Fax : (852) 2517 1797
E-mail : sales@toyo-led.com



P/N: TY-L1206UG1(0.80)

1206 Package 3.2*1.6mm Surface Mount LEDs Series

❖ Package & Shipping Instructions

