



TOYO LED ELECTRONICS LIMITED

Room 1610, Hong Kong Plaza, 188 Connaught Road West, Hong Kong.

Tel : (852) 2540 7288
http://www.toyo-led.com

Fax : (852) 2517 1797
E-mail : sales@toyo-led.com



P/N: TY-L1206BL1(0.80)

1206 Package 3.2*1.6mm Surface Mount LEDs Series

SPECIFICATION FOR CUSTOMER APPROVAL

P/N: TY-L1206BL1(0.80)

DATE : January 12, 2014

PREPARED BY : Yanguoliang

CONFIRMED BY :

PLEASE CONFIRM & SIGN BACK THIS SHEET TO US

CUSTOMER: _____

(COMPANY CHOP)

APPROVAL BY: _____

(SIGNATURE)



TOYO LED ELECTRONICS LIMITED

Room 1610, Hong Kong Plaza, 188 Connaught Road West, Hong Kong.

Tel : (852) 2540 7288
http://www.toyo-led.com

Fax : (852) 2517 1797
E-mail : sales@toyo-led.com



P/N: TY-L1206BL1(0.80)

1206 Package 3.2*1.6mm Surface Mount LEDs Series

✧ Features:

- 3.2*1.6*0.8 mm
- Mono-color type
- Soldering methods :All SMT assembly methods
- Comply ROHS standard

✧ Description

The Blue source color devices are made with **InGaN** on sapphire Light Emitting Diode.

✧ Application

- Optical indicator
- Indicator and backlighting in telephone and fax
- Flat backlight for LCD, switch and symbol
- Light pipe application
- General use

✧ Package Dimensions

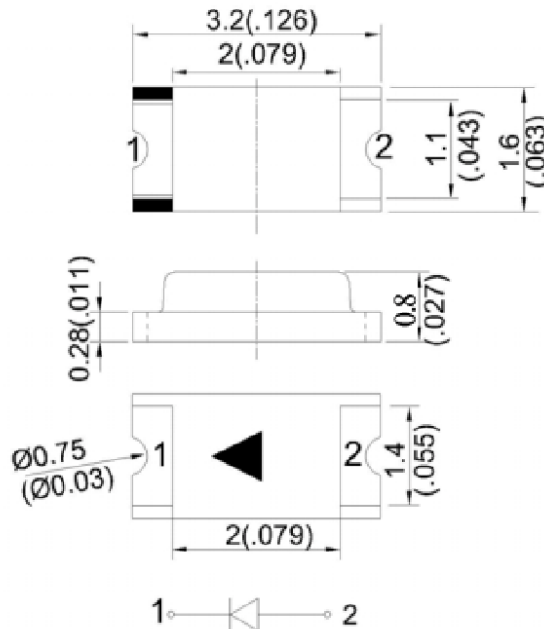

NOTES:

1. All dimensions are in millimeter[unit];
2. Tolerance is $\pm 0.1\text{mm}$ (0.004") unless other specified;
3. Specifications are subject to change without notice.



TOYO LED ELECTRONICS LIMITED

Room 1610, Hong Kong Plaza, 188 Connaught Road West, Hong Kong.

Tel : (852) 2540 7288
http://www.toyo-led.com

Fax : (852) 2517 1797
E-mail : sales@toyo-led.com



P/N: TY-L1206BL1(0.80)

1206 Package 3.2*1.6mm Surface Mount LEDs Series

Part No.	Emitted Color	Lens Color	Chip Material
TY-L1206BL1(0.80)	Blue	Water Clear	InGaN

◇ Absolute Maximum Ratings(Ta=25°C)

Item	Symbol	Maximum	Unit
Power Dissipation	PD	114	mW
Continuous Forward Current	I _{Fmax}	30	mA
Peak Forward Current(1/10 Duty Cycle 0.1ms Pulse Width)	I _{FP}	160	mA
Reverse Voltage	V _R	5	V
Operating Temperature Range	T _{opr}	-40 to+85	°C
Storage Temperature Range	T _{stg}	-40 to+85	°C
Lead Solder Temperature	Tsol	260 °C for 3 seconds	

◇ Electrical/Optical Characteristics(Ta=25°C)

Item	Symbol	Condition	Min.	Typ.	Max	Unit
Forward Voltage	V _F	I _F =20mA	2.8	3.2	3.6	V
Luminous Intensity	I _v	I _F =20mA	80	100	140	mcd
Wavelength	λ	I _F =20mA	465	470	---	nm
Viewing Angle	2θ _{1/2}	I _F =20mA	---	120	---	Deg
Reverse Current	I _R	V _R =5V	---	---	10	uA



TOYO LED ELECTRONICS LIMITED

Room 1610, Hong Kong Plaza, 188 Connaught Road West, Hong Kong.

Tel : (852) 2540 7288
<http://www.toyo-led.com>

Fax : (852) 2517 1797
 E-mail : sales@toyo-led.com



P/N: TY-L1206BL1(0.80)

1206 Package 3.2*1.6mm Surface Mount LEDs Series

◇ Typical Electro-Optical Characteristics Curves

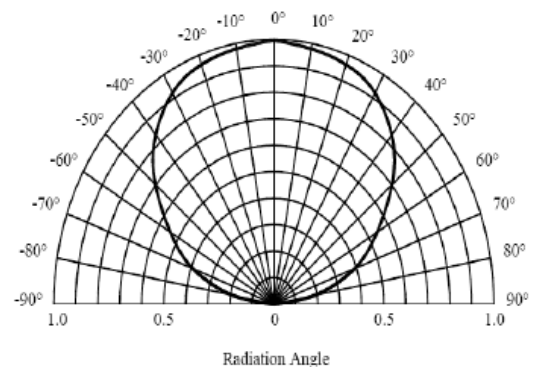
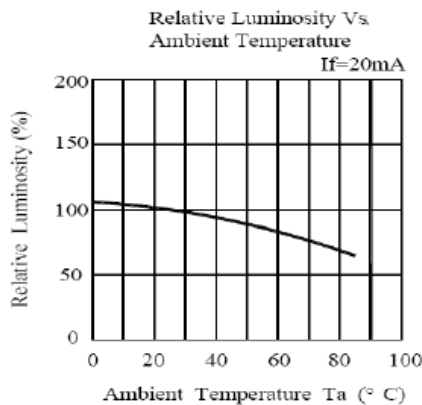
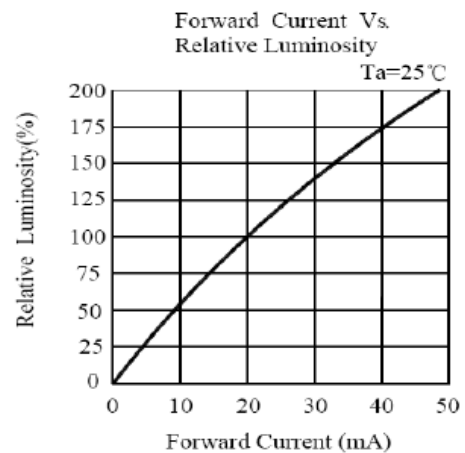
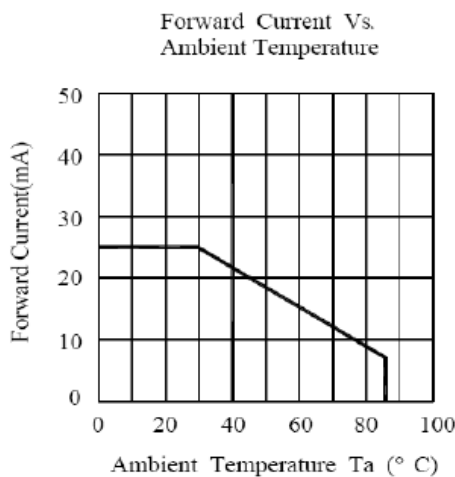
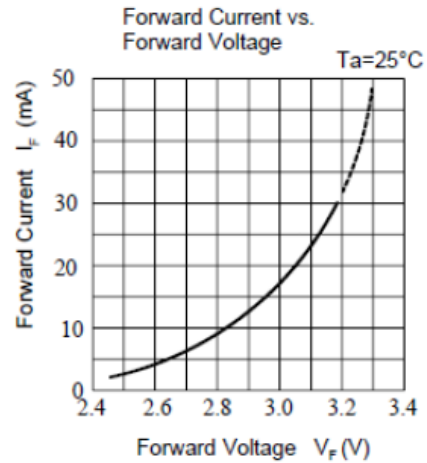
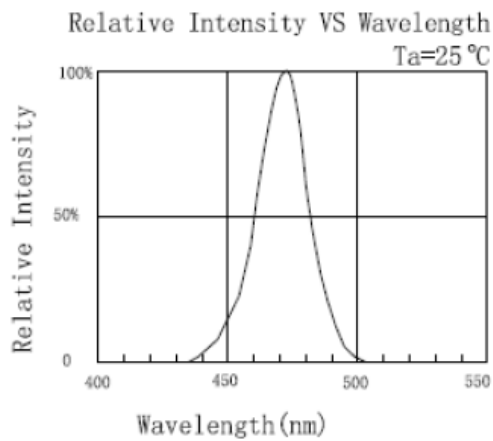



TOYO LED ELECTRONICS LIMITED

Room 1610, Hong Kong Plaza, 188 Connaught Road West, Hong Kong.
 Tel : (852) 2540 7288 Fax : (852) 2517 1797
 http://www.toyo-led.com E-mail : sales@toyo-led.com



P/N: TY-L1206BL1(0.80)

1206 Package 3.2*1.6mm Surface Mount LEDs Series

◇ Reliability Test Items And Conditions

NO.	Item	Test Condition	Test Hr/cycle/time	Sample Q'ty	Ac/Re
1	Reflow	TEMP:260±5°C; Min.5Sec	6 min	22pcs	0/1
2	Temperature Cycle	H:+90°C 30mins To(5mins) L:-30°C 30mins	300 cycles	22pcs	0/1
3	Thermal Shock	H:+100°C 20mins To(5mins) L:-40°C 20mins	300 cycles	22pcs	0/1
4	High Temperature Storage	TEMP:+100°C	1000hrs	22pcs	0/1
5	Low Temperature Storage	TEMP:-30°C	1000hrs	22pcs	0/1
6	DC Operating Life	IF=20MA	1000hrs	22pcs	0/1
7	High Temperature	65°C	240hrs	22pcs	0/1
8	High Humidity	R.H.= 85%		22pcs	0/1

◇ SMT Reflow Soldering Instructions

Number of reflow process shall be than 2 times and cooling

Process to normal temperature is required between first and second soldering process

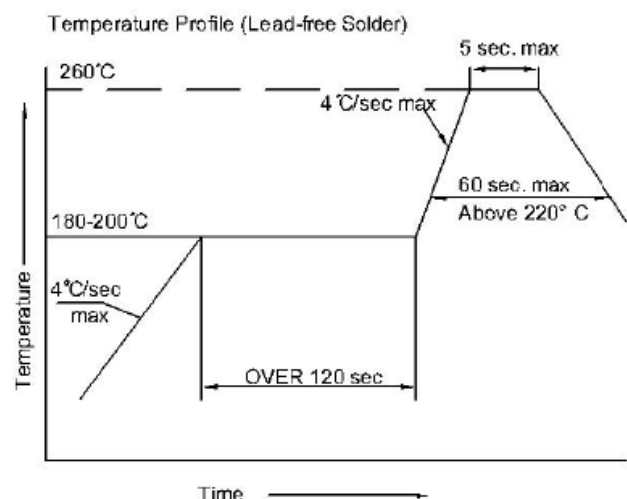
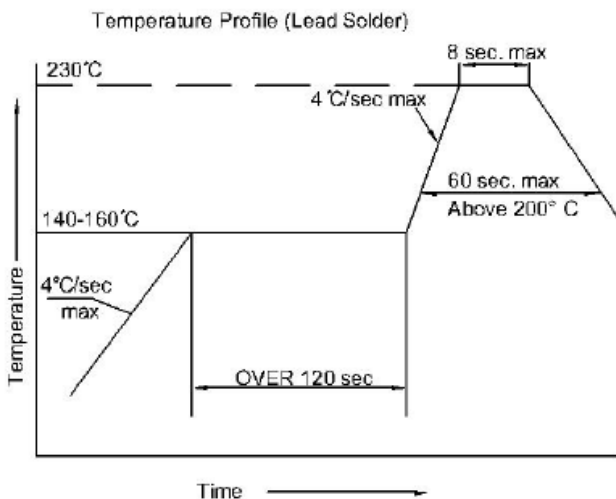



TOYO LED ELECTRONICS LIMITED

Room 1610, Hong Kong Plaza, 188 Connaught Road West, Hong Kong.
Tel : (852) 2540 7288 Fax : (852) 2517 1797
http://www.toyo-led.com E-mail : sales@toyo-led.com



P/N: TY-L1206BL1(0.80)

1206 Package 3.2*1.6mm Surface Mount LEDs Series

Recommended Soldering Pad Dimensions

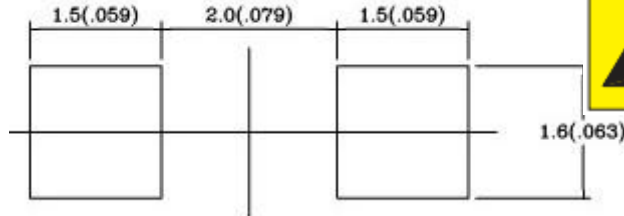

Tape Specification: 3,000pcs

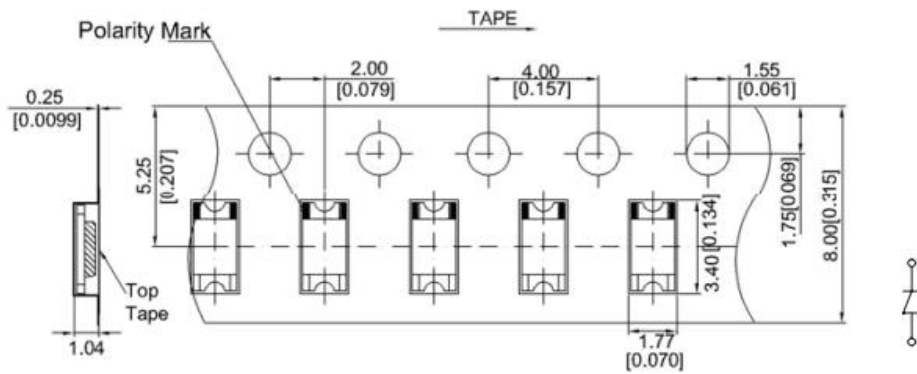
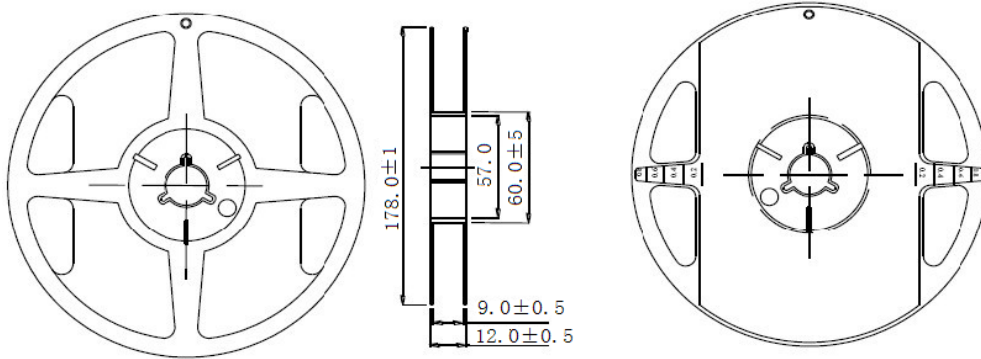

Package Label

SMD LED	
PART NO: _____	QA Pass
LOT NO : _____	
Q' TY : _____	Pb
VF : _____ IV : _____	
TC : _____ BIN: _____	
DATE : _____	
TOYO LED ELECTRONICS LIMITED	
Website: http://www.toyo-led.com E-mail: sales@toyo-led.com	



TOYO LED ELECTRONICS LIMITED

Room 1610, Hong Kong Plaza, 188 Connaught Road West, Hong Kong.

Tel : (852) 2540 7288
http://www.toyo-led.com

Fax : (852) 2517 1797
E-mail : sales@toyo-led.com



P/N: TY-L1206BL1(0.80)

1206 Package 3.2*1.6mm Surface Mount LEDs Series

❖ Package & Shipping Instructions

