



P-Channel 60-V (D-S) MOSFET

PRODUCT SUMMARY

Part Number	$V_{(BR)DSS}$ Min (V)	$r_{DS(on)}$ Max (Ω)	$V_{GS(th)}$ (V)	I_D (A)
TP0610L	-60	10 @ $V_{GS} = -10$ V	-1 to -2.4	-0.18
TP0610T	-60	10 @ $V_{GS} = -10$ V	-1 to -2.4	-0.12
VP0610L	-60	10 @ $V_{GS} = -10$ V	-1 to -3.5	-0.18
VP0610T	-60	10 @ $V_{GS} = -10$ V	-1 to -3.5	-0.12
BS250	-60	10 @ $V_{GS} = -10$ V	-1 to -3.5	-0.18

FEATURES

- High-Side Switching
- Low On-Resistance: 8 Ω
- Low Threshold: -1.9 V
- Fast Switching Speed: 16 ns
- Low Input Capacitance: 15 pF

BENEFITS

- Ease in Driving Switches
- Low Offset (Error) Voltage
- Low-Voltage Operation
- High-Speed Switching
- Easily Driven Without Buffer

APPLICATIONS

- Drivers: Relays, Solenoids, Lamps, Hammers, Displays, Memories, Transistors, etc.
- Battery Operated Systems
- Power Supply, Converter Circuits
- Motor Control

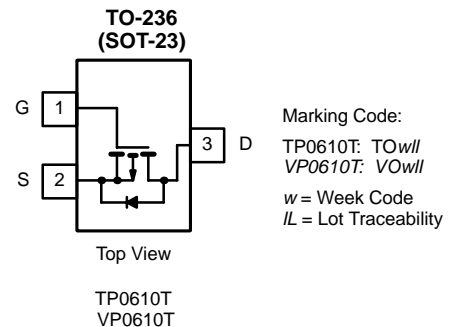
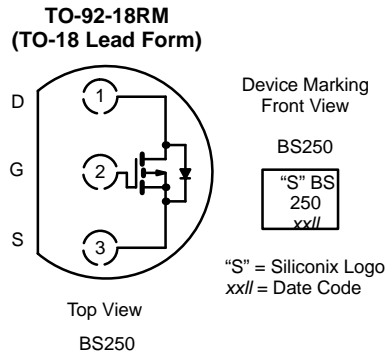
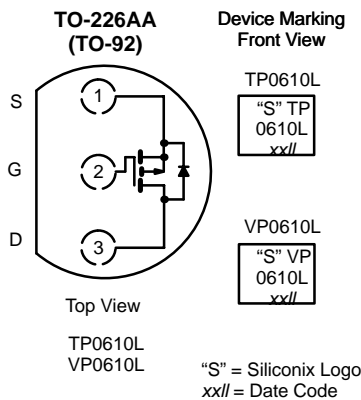

ABSOLUTE MAXIMUM RATINGS ($T_A = 25^\circ\text{C}$ UNLESS OTHERWISE NOTED)

Parameter	Symbol	TP0610L	TP0610T	VP0610L	VP0610T	BS250	Unit	
Drain-Source Voltage	V_{DS}	-60	-60	-60	-60	-60	V	
Gate-Source Voltage	V_{GS}	± 20	± 20	± 20	± 20	± 20		
Continuous Drain Current ($T_J = 150^\circ\text{C}$)	$T_A = 25^\circ\text{C}$	-0.18	-0.12	-0.18	-0.12	-0.18	A	
	$T_A = 100^\circ\text{C}$	-0.11	-0.07	-0.11	-0.07			
Pulsed Drain Current ^a	I_{DM}	-0.8	-0.4	-0.8	-0.4			
Power Dissipation	$T_A = 25^\circ\text{C}$	0.8	0.36	0.8	0.36	0.83	W	
	$T_A = 100^\circ\text{C}$	0.32	0.14	0.32	0.14			
Thermal Resistance, Junction-to-Ambient	R_{thJA}	156	350	156	350	150	$^\circ\text{C}/\text{W}$	
Operating Junction and Storage Temperature Range	T_J, T_{stg}	-55 to 150						$^\circ\text{C}$

Notes

a. Pulse width limited by maximum junction temperature.

For applications information see AN804.



SPECIFICATIONS (T _A = 25 °C UNLESS OTHERWISE NOTED)										
Parameter	Symbol	Test Conditions	Typ ^a	Limits						Unit
				TP0610L/T		VP0610L/T		BS250		
				Min	Max	Min	Max	Min	Max	
Static										
Drain-Source Breakdown Voltage	V _{(BR)DSS}	V _{GS} = 0 V, I _D = -10 μA		-60		-60				V
		V _{GS} = 0 V, I _D = -100 μA					-60			
Gate-Threshold Voltage	V _{GS(th)}	V _{DS} = V _{GS} , I _D = -250 μA		-1	-2.4	-1	-3.5	-1	-3.5	
Gate-Body Leakage	I _{GSS}	V _{DS} = 0 V, V _{GS} = ± 10 V			± 200		± 200			nA
		V _{DS} = 0 V, V _{GS} = ± 10 V, T _J = 125 °C			± 500					
		V _{DS} = 0 V, V _{GS} = ± 5 V							± 100	
Zero Gate Voltage Drain Current	I _{DSS}	V _{DS} = -48 V, V _{GS} = 0 V			-1		-1			μA
		V _{DS} = -48 V, V _{GS} = 0 V, T _J = 125 °C			-200		-200			
		V _{DS} = -25 V, V _{GS} = 0 V							-0.5	
On-State Drain Current ^b	I _{D(on)}	V _{DS} = -10 V, V _{GS} = -4.5 V		-50						mA
		V _{DS} = -10 V, V _{GS} = -10 V	-600			-600				
Drain-Source On-Resistance ^b	r _{DS(on)}	V _{GS} = -4.5 V, I _D = -25 mA			25					Ω
		V _{GS} = -10 V, I _D = -0.5 A			10		10			
		V _{GS} = -10 V, I _D = -0.5 A, T _J = 125 °C			20		20			
		V _{GS} = -10 V, I _D = -0.2 A			10		10		14	
Forward Transconductance ^b	g _{fs}	V _{DS} = -10 V, I _D = -0.5 A	20	80						mS
Diode Forward Voltage	V _{SD}	I _S = -0.5 A, V _{GS} = 0 V	-1.1		-1.4					V
Dynamic										
Input Capacitance	C _{iss}	V _{DS} = -25 V, V _{GS} = 0 V f = 1 MHz	23		60		60			pF
Output Capacitance	C _{oss}		10		25		25			
Reverse Transfer Capacitance	C _{rss}		5		5		5			
Switching^c										
Turn-On Time	t _{ON}	V _{DD} = -25 V, R _L = 133 Ω I _D ≅ -0.18 A, V _{GEN} = -10 V R _G = 25 Ω	20							ns
Turn-Off Time	t _{OFF}		35							

Notes

- a. For DESIGN AID ONLY, not subject to production testing.
- b. Pulse test: PW ≤ 300 μs duty cycle ≤ 2%.
- c. Switching time is essentially independent of operating temperature.

VPDS06



TYPICAL CHARACTERISTICS (25°C UNLESS NOTED)

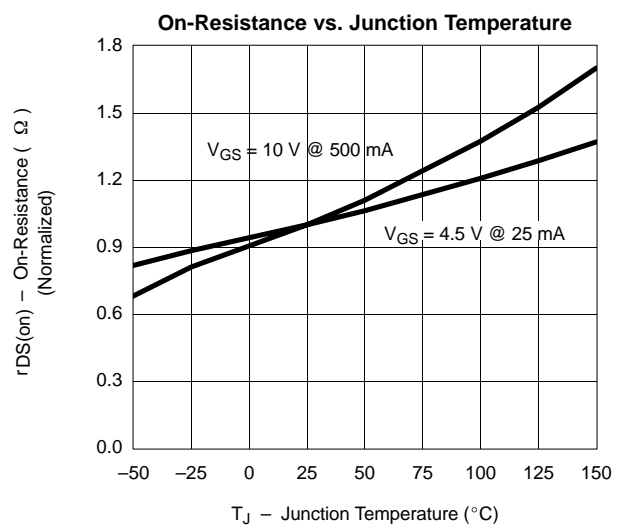
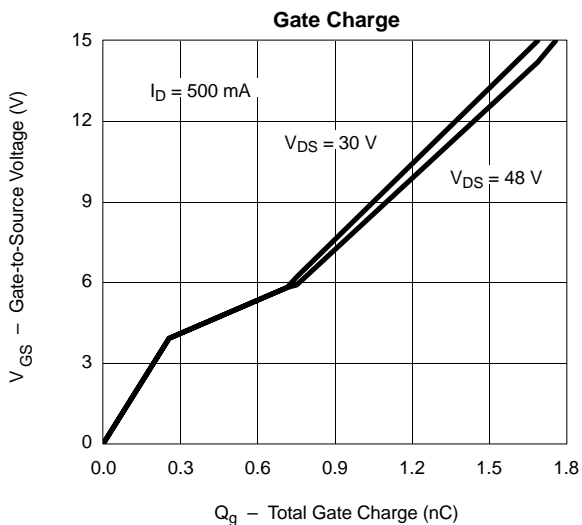
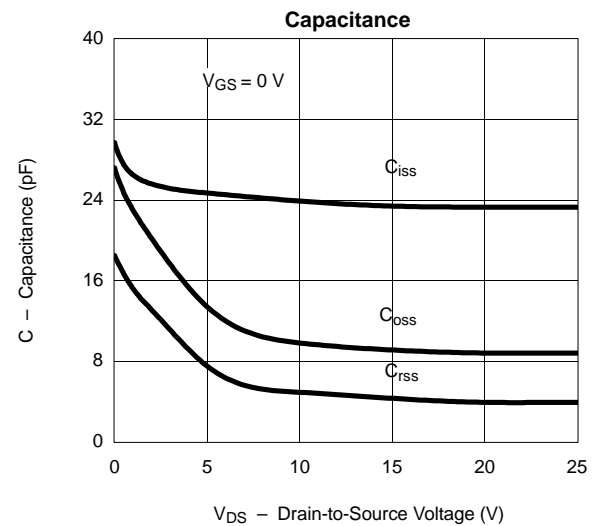
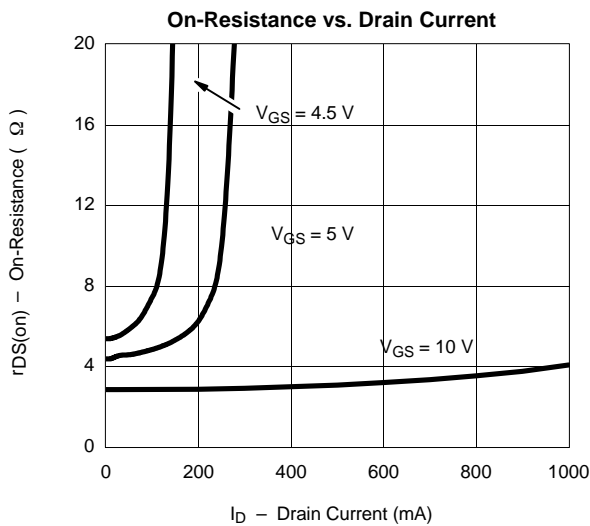
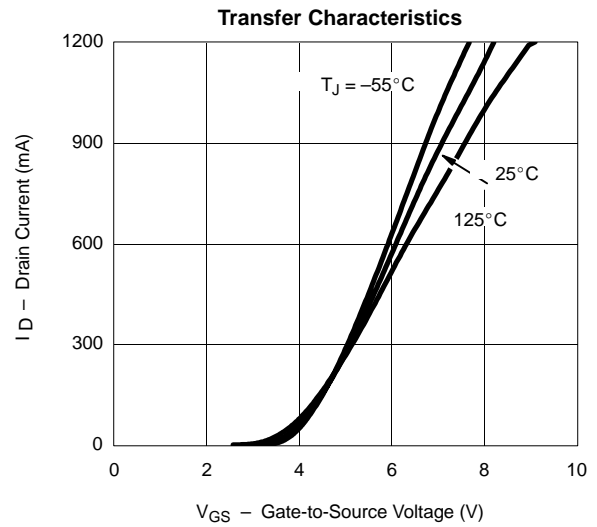
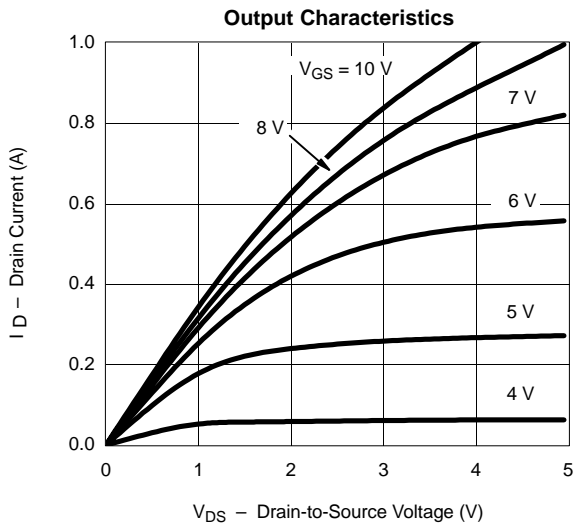

TYPICAL CHARACTERISTICS (25°C UNLESS NOTED)

