

Chip tantalum capacitors

TC Series

●Features (M)

Newly designed ROHM original CSP structure (face-down terminal) provides,

- 1) Excellent adhesion.
- 2) Easy visual recognition of fillets.
- 3) Expanded capacitance range with Low ESR.

●External dimensions (Unit : mm)

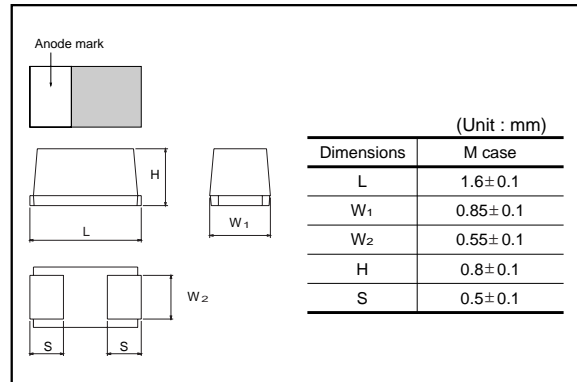

●Features (P , A)

- 1) Vital for all hybrid integrated circuits board application.
- 2) Wide capacitance range.
- 3) Screening by thermal shock.

●External dimensions (Unit : mm)

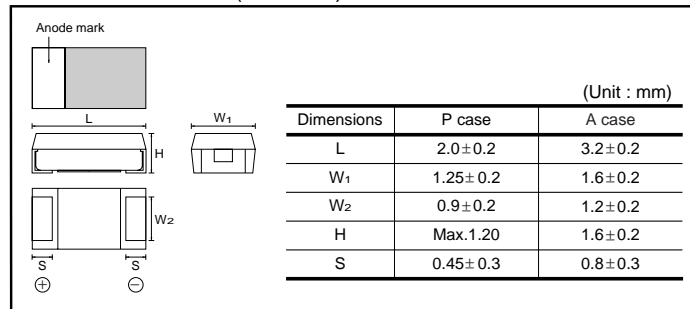

●Model name configuration

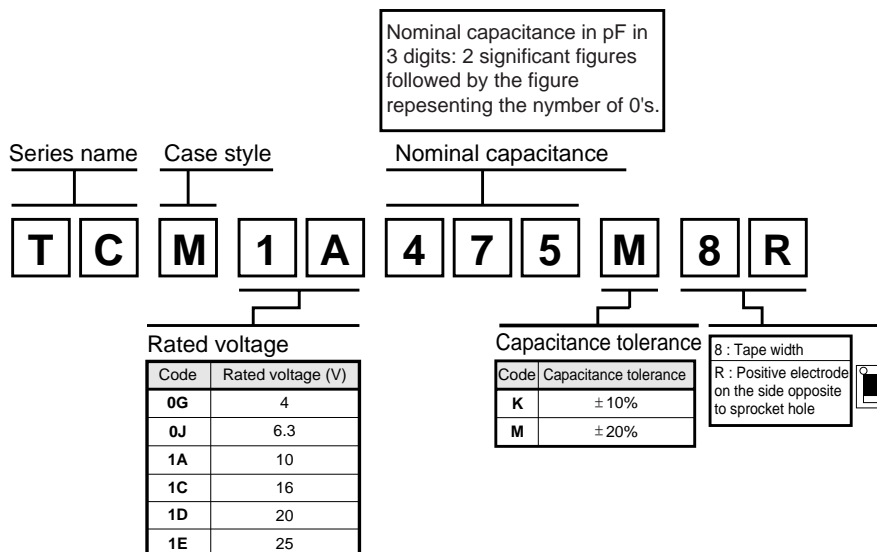

Tantalum capacitors

●Rated Table. Marking

	μF	Rated voltage (V.DC)					
		4 0G	6.3 0J	10 1A	16 1C	20 1D	25 1E
A	1.0			M,P	M,P,A	P,A	P,A
E	1.5		P	P,A	A	A	A
J	2.2	P	P	M,P,A	A	A	A
N	3.3	P	P,A	P,A	A	A	A
S	4.7	M,P,A	M,P,A	M,P,A	A	A	
W	6.8	P,A	W,P,A	P,A	A		
a	10	M,P,A	M,P,A	P,A	A		
e	15	P,A	P,A	A			
j	22	M,P,A	A	A			
n	33	A	A				
s	47	A	A				
w	68	A					

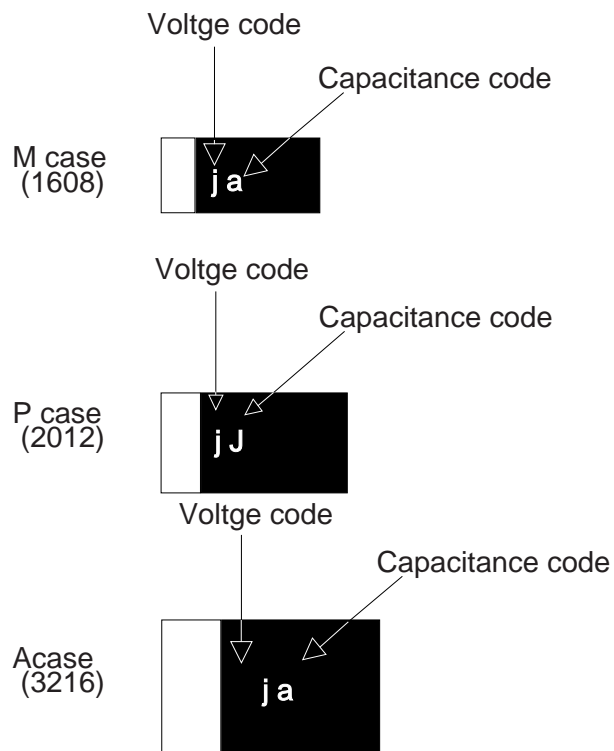

Tantalum capacitors

●Characteristics

Item	Performance						Test conditions (based on JIS C 5101-1 and JIS C 5101-3)		
Operating Temperature	-55°C~+125°C						Voltage reduction when temperature exceeds+85°C		
Maximum operating temperature with no voltage derating	+85°C								
Rated voltage (VDC)	M case	4	6.3	10	16		at 85°C		
	P, Acase	4	6.3	10	16	20			
Category voltage (VDC)	M case	2.5	4	6.3	10		at 125°C		
	P, Acase	2.5	4	6.3	10	13			
Surge voltage (VDC)	M case	5.2	8	13	20		at 85°C		
	P, Acase	5.2	8	13	20	26			
DC Leakage current	0.5 μF or 0.01CV whichever is greater Shown in " Standard list "						Mcase	Rated voltage for 5min	
							P,Acase	Rated voltage for 1min	
Capacitance tolerance	M case	±20% Shall be satisfied allowance range.					Measuring frequency : 120±12Hz Measuring voltage : 0.5Vrms +1.5~2V.DC Measuring circuit : DC Equivalent series circuit		
	P,Acase	±10%, ±20% Shall be satisfied allowance range.							
Tangent of loss angle (Df, tan δ)	Shall be satisfied the voltage on " Standard list "						Measuring frequency : 120±12Hz Measuring voltage : 0.5Vrms +1.5~2V.DC Measuring circuit : DC Equivalent series circuit		
Impedance	Shall be satisfied the voltage on " Standard list "						Measuring frequency : 100±10kHz Measuring voltage : 0.5Vrms or less		
Resistance to Soldering heat	Appearance	There should be nosignificant abnormality. The indications should be clear.						Dip in the solder bath Solder temp : 260±5°C Duration : 5±0.5s Repetition : 1	
		L.C.	M case	Less than 200% of initial limit					
	P,Acase		Shall be satisfied the value in Item No.6						
	ΔC / C	M case	Within ±20% of initial value						
		P case	±10% of initial value						
		A case	± 5% of initial value						
	Df (tan δ)	M case	Less than 200% of initial limit						
P case		Less than 150% of initial limit							
A case		Less than initial limit							

Tantalum capacitors

Item		Performance		Test conditions (based on JIS C 5101-1 and JIS C 5101-3)															
Temperature cycle	Appearance	There should be no significant abnormality.		Repetition : 5 cycles (1 cycle : steps 1~4) without discontinuation. <table border="1" style="margin-top: 10px;"> <thead> <tr> <th></th> <th>Temp.</th> <th>Time</th> </tr> </thead> <tbody> <tr> <td>1</td> <td>-55±3°C</td> <td>30±3min</td> </tr> <tr> <td>2</td> <td>Room temp.</td> <td>3min.or less</td> </tr> <tr> <td>3</td> <td>125±2°C</td> <td>30±3min</td> </tr> <tr> <td>4</td> <td>Room temp.</td> <td>3min.or less</td> </tr> </tbody> </table>		Temp.	Time	1	-55±3°C	30±3min	2	Room temp.	3min.or less	3	125±2°C	30±3min	4	Room temp.	3min.or less
		Temp.	Time																
	1	-55±3°C	30±3min																
	2	Room temp.	3min.or less																
	3	125±2°C	30±3min																
	4	Room temp.	3min.or less																
	L.C	M case	Less than 200% of initial limit																
		P , A case	Less than initial limit																
	ΔC / C	M cas	Within ±20% of initial limit																
		P case	1~10μF: within ±10% of initial value 15~22μF: within ±20% of initial value																
A case		TCA1A226□, TCA0J476□: Within±15% of intial value Others: Within±10% of initial value																	
Df (tan δ)	M case	Less than 200% of initial limit																	
	P case	Less than 150% of initial limit																	
	A case	Less than initial limit																	
Moisture resistance	Appearance	There should be no significant abnormality. The indications should be		After leaving the sample under such atmospheric condition that the temperature and humidity are 60 ±2 C and 90 to 95% RH, respectively, for 500 12h leave it at room temperature for 1 to 2h and then measure the sample.															
	L.C	M case	Less than 200% of initial limit																
		P , A case	Shall be satisfied the value in Item No.6																
	ΔC / C	M , P case	Within± 20% of initial limit																
		A case	Within± 10% of initial limit																
	Df (tan δ)	M case	Less than 200% of initial limit																
		P case	Less than 150% of initial limit																
		A casr	Less than initial limit																
Temperature Stability	Temp.	-55°C																	
	ΔC / C	M , P case	Within 0/-15% of initial value																
		A case	Within 0/-12% of initial value																
	Df (tan δ)	Shall be satisfied the voltage on " Standard list "																	
	L.C	-																	
	Temp.	+85°C																	
	ΔC / C	M , P case	Within +15/0 of initial value																
		A case	Within +12/0% of initial value																
	Df (tan δ)	Shall be satisfied the voltage on " Standard list "																	
	L.C	5 μA or 0.1CV whichever is greater																	
	Temp.	+125°C																	
	ΔC / C	M , P case	Within +20/0 of initial value																
		A case	Within +15/0% of initial value																
	Df (tan δ)	Shall be satisfied the voltage on " Standard list "																	
	L.C	6.3 μA or 0.125CV whichever is greater																	
Surge voltage	Appearance	There should be no significant avnormality.		Apply the spesified sergevoltage every 5±0.5 min. for 30±5 s. each time in the atmospheric condition of 85±2°C. Repeat this rocedure 1,000 times.															
	L.C	M case	Less than 200% of initial limit																
		P , A case	Less than initial limit																
	ΔC / C	M case	Within± 20% of initial value																
		P case	Within± 10% of initial value																
	Df (tan δ)	M case	Less than 200% of initial limit																
		P case	Less than 150% of initial limit																
A case		Less than initial limit																	

Tantalum capacitors

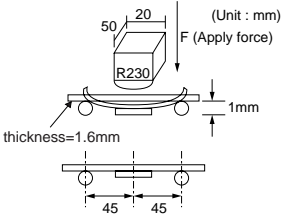
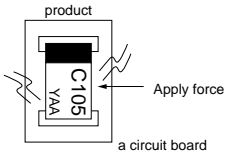
Item		Performance		Test conditions (based on JIS C 5101-1 and JIS C 5101-3)
Loading at High temperature	Appearance	M, A case	There should be no significant abnormality.	M, P case : After applying the rated voltage for 1000 ⁺³⁶ h without discontinuation via the serial resistance of 3Ω or less at a temperature of 85±2°C, leave the sample at room temperature / humidity for 1 to 2h and measure the value. A case : After applying the rated voltage for 2000 ⁺⁷² h without discontinuation via the serial resistance of 3Ω or less at a temperature of 85±2°C, leave the sample at room temperature / humidity for 1 to 2h and measure the value.
		P case	There should be no significant abnormality. The indications should be clear.	
	L.C	M case	Less than 200% of initial limit	
		P, A case	Less than initial limit	
	ΔC / C	M case	Within ±20% of initial value	
		P case	Within ±10% of initial value	
		A case	TCA1A226 □, TCA0J476 □ within ±15% of initial value Others within ±10% of initial value	
	Df (tan δ)	M case	Less than 200% of initial limit	
P case		150% of initial limit less than		
A case		Less than initial limit		
Terminal strength	Capacitance	The measured value should be stable.		A force is applied to the terminal until it bends to 1mm and by a prescribed tool maintain the condition for 5s. (See the figure below) 
	Appearance	There should be no significant abnormality.		
Adhesiveness	The terminal should not come off.		Apply force of 5N in the two directions shown in the figure below for 10±1s after mounting the terminal on a circuit board. 	
Dimensions	Refer to "External dimensions"		Measure using a caliper of JISB 7507 Class 2 or higher grade.	
Resistance to solvents	The indication should be clear		Dip in the isopropyl alcohol for 30±5s, at room temperature.	
Solderability	3 / 4 or more surface area of the solder coated terminal dipped in the soldering bath should be covered with the new solder.		Dip speed=25±2.5mm / s Pre-treatment(accelerated aging): Leave the sample on the boiling distilled water for 1 h. Solder temp. : 235±5°C Duration : 2±0.5s Solder : H63A Flux : Rosin25% IPA75%	
Vibration	Capacitance	Measure value should not fluctuate during the measurement.		Frequency : 10 to 55 to 10Hz/min. Amplitude : 1.5mm Time : 2h each in X and Y directions Mounting : The terminal is soldered on a printed circuit board.
	Appearance	There should be no significant abnormality.		

Tantalum capacitors

●Standard list, TC series

< M case : 1608 size >

Part No.	Rated Voltage 85°C (V)	Category Voltage 125°C (V)	Surge Voltage 85°C (V)	Cap. 120Hz (μF)	Tolerance (%)	Leakage Current 25°C 1WV 5min (μA)	Df 120Hz (%)			Impedance 100kHz (Ω)
							-55°C	25°C 85°C	125°C	
TC M 0G 475 □	4	2.5	5.2	4.7	±20	0.5	30	20	30	9.0
TC M 0G 106 □				10						
TC M 0G 226 □				22						
TC M 0J 475 □	6.3	4	8	4.7	±20	0.5	30	20	30	9.0
TC M 0J 685 □				6.8						
TC M 0J 106 □				10						
TC M 1A 105 □	10	6.3	13	1.0	±20	0.5	15	10	15	15.0
TC M 1A 225 □				2.2			30	20	30	13.5
TC M 1A 475 □				4.7			30	20	30	9.0
TC M 1C 105 □	16	10	20	1.0	±20	0.5	15	10	15	15.0

□=Tolerance (M :±20%)

Tantalum capacitors

< P case : 2012 size >

Part No.	Rated Voltage 85°C (V)	Cstegory Voltage 125°C (V)	Surge Voltage 85°C (V)	Cap. 120Hz (mF)	Tolerance (%)	Leakage Current 25°C 1WV.60s (mA)	Df 120Hz (%)			Impedance 100kHz (Ω)
							-55°C	25°C 85°C	125°C	
TC P 0G 225□	4	2.5	5.2	2.2	±20,10	0.5	15	10	15	27.5
TC P 0G 335□				3.3						
TC P 0G 475□				4.7						
TC P 0G 685□				6.8						
TC P 0G 106□				10						
TC P 0G 156□				15						
TC P 0G 226□				22						
TC P 0J 155□	6.3	4	8	1.5	±20,10	0.5	15	10	15	27.5
TC P 0J 225□				2.2						
TC P 0J 335□				3.3						
TC P 0J 475□				4.7						
TC P 0J 685□				6.8						
TC P 0J 106□				10						
TC P 0J 156□				15						
TC P 1A 105□	10	6.3	13	1.0	+20,10	0.5	15	10	15	27.5
TC P 1A 155□				1.5						
TC P 1A 225□				2.2						
TC P 1A 335□				3.3						
TC P 1A 475□				4.7						
TC P 1A 685□				6.8						
TC P 1A 106□				10						
TC P 1C 105□	16	10	20	1.0	±20,10	0.5	15	10	15	27.5

□=Tolerance (M : ±20%,K : ±10%)

Tantalum capacitors

< A case : 3216 size >

Part No.	Rated Voltage 85°C (V)	Category Voltage 125°C (V)	Surge Voltage 85°C (V)	Cap. 120Hz (μF)	Tolerance (%)	Leakage Current 25°C 1WV 5min (μA)	Df 120Hz (%)			Impedance 100kHz (Ω)
							-55°C	25°C 85°C	125°C	
TC A 0G 475□	4	2.5	5.2	4.7	±20,10	0.5	10	6	8	20.0
TC A 0G 685□				6.8			12	8	10	
TC A 0G 106□				10						
TC A 0G 156□				15						
TC A 0G 226□				22						
TC A 0G 336□				33						
TC A 0G 476□				47						
TC A 0G 686□				68						
TC A 0J 335□	6.3	4	8	3.3	±20,10	0.5				10
TC A 0J 475□				4.7			12	8	10	
TC A 0J 685□				6.8						
TC A 0J 106□				10						
TC A 0J 156□				15						
TC A 0J 226□				22						
TC A 0J 336□				33						
TC A 0A 476□				47						
TC A 1A 155□	10	6.3	13	1.5	±20,10	0.5				10
TC A 1A 225□				2.2			12	8	10	
TC A 1A 335□				3.3						
TC A 1A 475□				4.7						
TC A 1A 685□				6.8						
TC A 1A 106□				10						
TC A 1A 156□				15						
TC A 1A 226□				22						
TC A 1C 105□	16	10	20	1.0	±20,10	0.5				10
TC A 1C 155□				1.5						
TC A 1C 225□				2.2						
TC A 1C 335□				3.3						
TC A 1C 475□				4.7						
TC A 1C 685□				6.8						
TC A 1C 106□				10						
TC A 1D 105□	20	13	26	1.0	±20,10	0.5	10	6	8	20.0

□=Tolerance (M : ±20%, K : ±10%)

Tantalum capacitors

●Packaging specifications

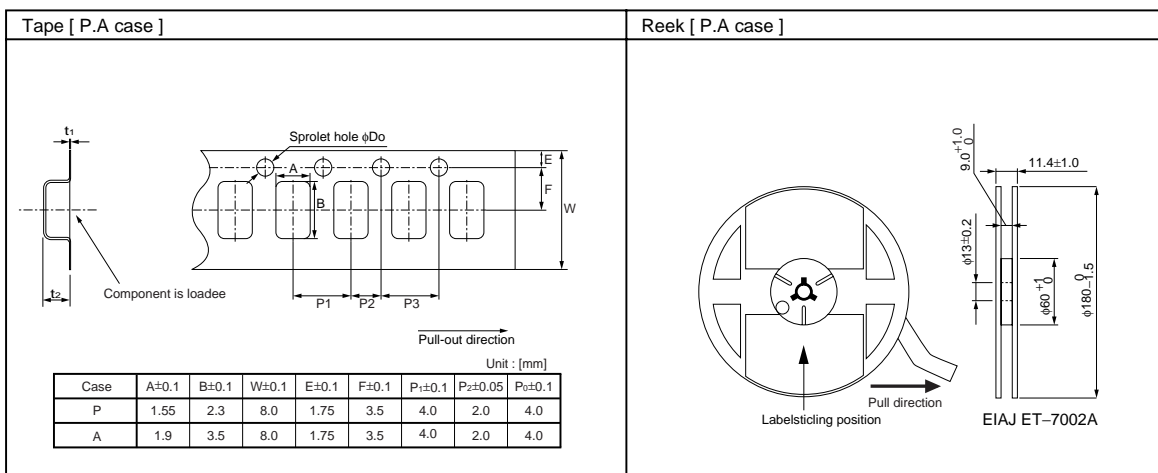
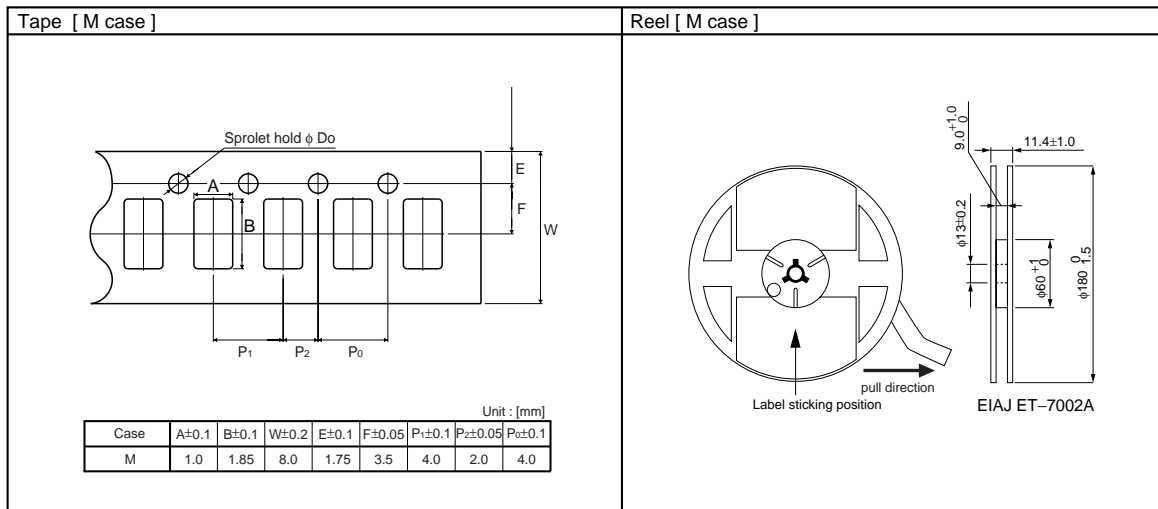

●Packaging style

Case code	package	Packaging style		Symbol	Basic ordering units
M	Taping	plastic taping	ϕ 180mm Reel	R	4,000pcs
P					3,000pcs
A					2,000pcs

Tantalum capacitors

● Electrical characteristics and operation notes

(1) Soldering conditions (soldering temperature and soldering time)

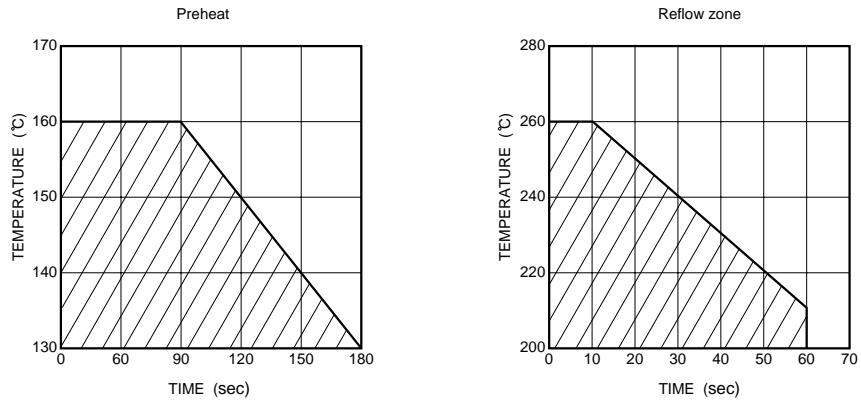

Fig.1 reflow soldering

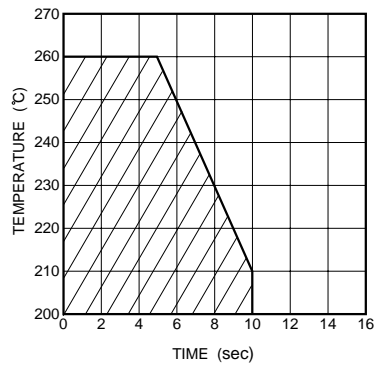

Fig.2 Flow soldering (Dip-wave soldering)

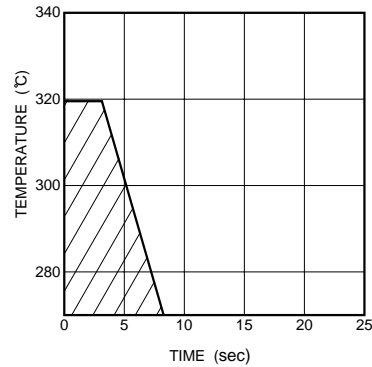

Fig.3 Hand soldering (Wattage : 30W MAX.)

(2) Leakage current-to-voltage ratio

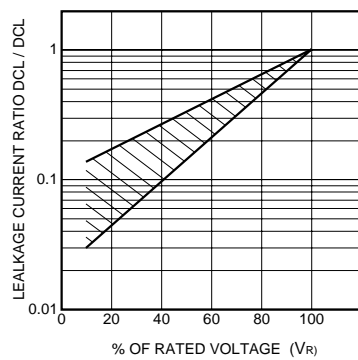

Fig.4

Tantalum capacitors

(3) Derating voltage as function of temperature

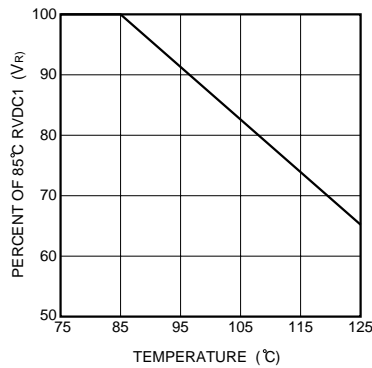

Fig.5

85 °C		125 °C	
Rated Voltage (V.DC)	Surge Voltage (V.DC)	Category Voltage (V.DC)	Surge Voltage (V.DC)
4	5.2	2.5	3.4
6.3	8	4	5
10	13	6.3	9
16	20	10	12
20	26	13	16

(4) Reliability

The malfunction rate of tantalum solid state electrolytic capacitors varies considerably depending on the conditions of usage (ambient temperature, applied voltage, circuit resistance).

Formula for calculating malfunction rate

$$\lambda p = \lambda b \times (\pi E \times \pi SR \times \pi Q \times \pi CV)$$

- λp : Malfunction rate stemming from operation
- λb : Basic malfunction rate
- πE : Environmental factors
- πSR : Series resistance
- πQ : Level of malfunction rate
- πCV : Capacitance

For details on how to calculate the malfunction rate stemming from operation, see the tantalum solid state electrolytic capacitors column in MIL-HDBK-217.

Malfunction rate as function of operating temperature and rated voltage

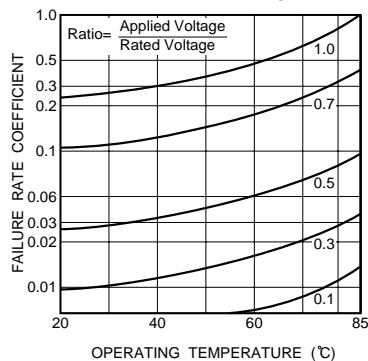

Fig.6

Malfunction rate as function of circuit resistance (Ω/V)

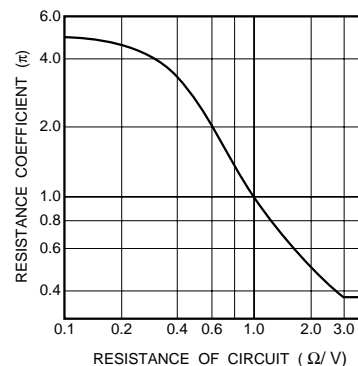

Fig.7

Tantalum capacitors

(5) Maximum power dissipation

Warming of the capacitor due to ripple voltage balances with warming caused by Joule heating and by radiated heat. Maximum allowable warming of the capacitor is to 5°C above ambient temperature. When warming exceeds 5°C, it can damage the dielectric and cause a short circuit.

Power dissipation (P) = $I^2 \cdot R$

Ripple current

P : As shown in table at right

R : Equivalent series resistance

Notes:

1. Please be aware that when case size is changed, maximum allowable power dissipation is reduced.
2. Maximum power dissipation varies depending on the package. Be sure to use a case which will keep warming within the limits shown in the table below.

Allowable power dissipation (W) and maximum temperature rising

Temp.	+25°C	+55°C	+85°C	+125°C
P case (2012)	0.025	0.022	0.020	0.010
A case (3216)	0.070	0.063	0.056	0.028
Max. Temp Rise [°C]	5	5	5	2

(6) Impedance frequency characteristics

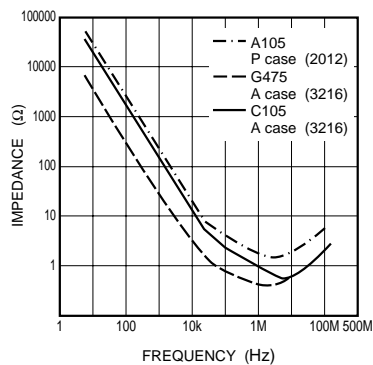

Fig.10

(7) ESR frequency characteristics

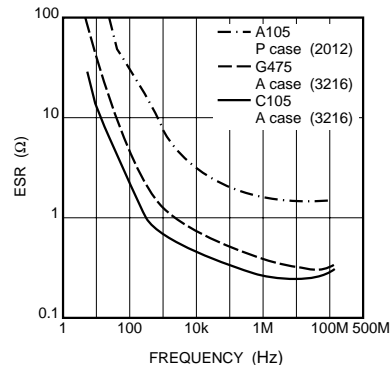

Fig.11

(8) Temperature characteristics

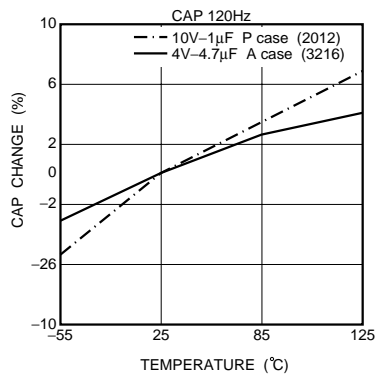

Fig.12

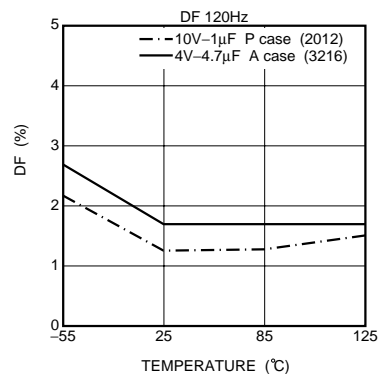

Fig.13

Tantalum capacitors

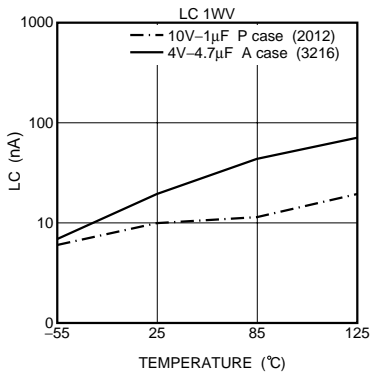

Fig.14

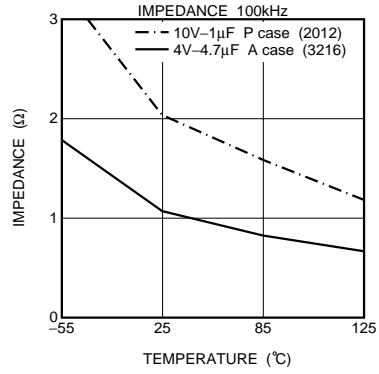

Fig.15

Rush current

The rush current is in inverse proportion to the ESR.
 The excessive rush current may cause a damage.

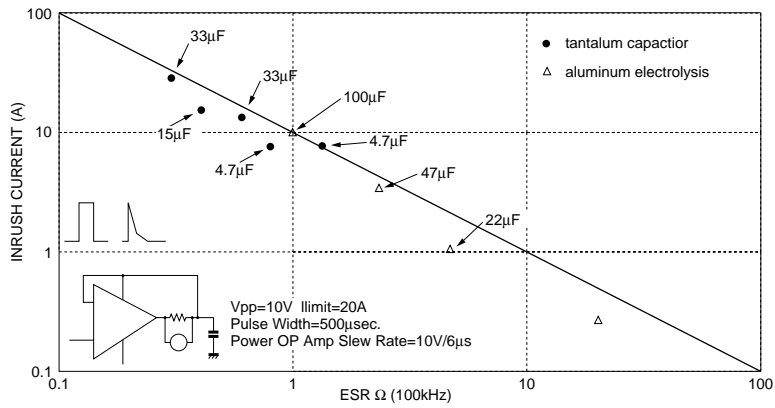

Fig. 16 Max. rush current and ESR

The rush current may be reduced by the protection resistors

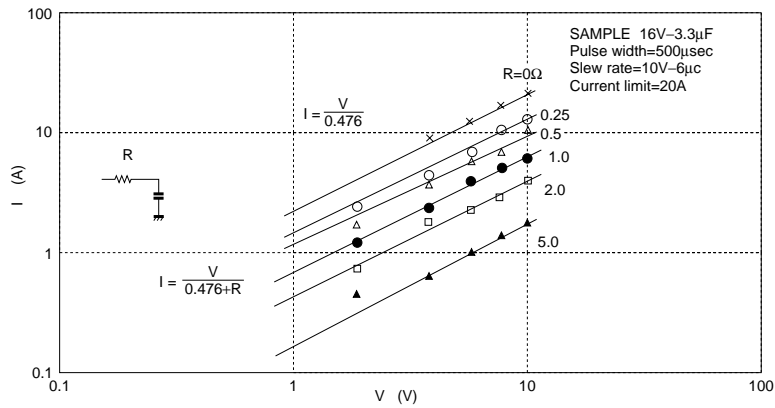

Fig. 17 Change in I max by protection resistors

Notes

- No technical content pages of this document may be reproduced in any form or transmitted by any means without prior permission of ROHM CO.,LTD.
- The contents described herein are subject to change without notice. The specifications for the product described in this document are for reference only. Upon actual use, therefore, please request that specifications to be separately delivered.
- Application circuit diagrams and circuit constants contained herein are shown as examples of standard use and operation. Please pay careful attention to the peripheral conditions when designing circuits and deciding upon circuit constants in the set.
- Any data, including, but not limited to application circuit diagrams information, described herein are intended only as illustrations of such devices and not as the specifications for such devices. ROHM CO.,LTD. disclaims any warranty that any use of such devices shall be free from infringement of any third party's intellectual property rights or other proprietary rights, and further, assumes no liability of whatsoever nature in the event of any such infringement, or arising from or connected with or related to the use of such devices.
- Upon the sale of any such devices, other than for buyer's right to use such devices itself, resell or otherwise dispose of the same, no express or implied right or license to practice or commercially exploit any intellectual property rights or other proprietary rights owned or controlled by
- ROHM CO., LTD. is granted to any such buyer.
- Products listed in this document are no antiradiation design.

The products listed in this document are designed to be used with ordinary electronic equipment or devices (such as audio visual equipment, office-automation equipment, communications devices, electrical appliances and electronic toys).

Should you intend to use these products with equipment or devices which require an extremely high level of reliability and the malfunction of which would directly endanger human life (such as medical instruments, transportation equipment, aerospace machinery, nuclear-reactor controllers, fuel controllers and other safety devices), please be sure to consult with our sales representative in advance.

About Export Control Order in Japan

Products described herein are the objects of controlled goods in Annex 1 (Item 16) of Export Trade Control Order in Japan.

In case of export from Japan, please confirm if it applies to "objective" criteria or an "informed" (by MITI clause) on the basis of "catch all controls for Non-Proliferation of Weapons of Mass Destruction.