

# SMBJ5.0(C)A - SMBJ170(C)A

## 600W SURFACE MOUNT TRANSIENT VOLTAGE SUPPRESSOR

### Features

- 600W Peak Pulse Power Dissipation
- 5.0V - 170V Standoff Voltages
- Glass Passivated Die Construction
- Uni- and Bi-Directional Versions Available
- Excellent Clamping Capability
- Fast Response Time
- **Lead Free Finish/RoHS Compliant (Note 4)**

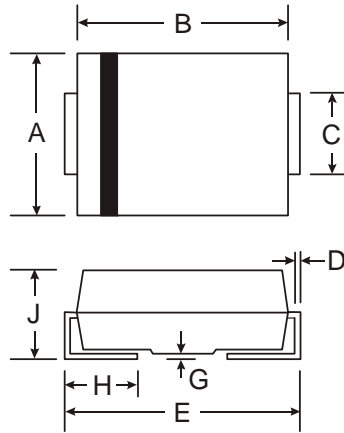

SMB		
Dim	Min	Max
A	3.30	3.94
B	4.06	4.70
C	1.91	2.21
D	0.15	0.31
E	5.00	5.59
G	0.10	0.20
H	0.76	1.52
J	2.00	2.62
<b>All Dimensions in mm</b>		

### Mechanical Data

- Case: SMB
- Case Material: Molded Plastic. UL Flammability Classification Rating 94V-0
- Moisture Sensitivity: Level 1 per J-STD-020C
- Terminals: Lead Free Plating (Matte Tin Finish). Solderable per MIL-STD-202, Method 208
- Polarity Indicator: Cathode Band (Note: Bi-directional devices have no polarity indicator.)
- Marking: Date Code and Marking Code See Page 4
- Ordering Info: See Page 4
- Weight: 0.1 grams (approximate)

### Maximum Ratings @T<sub>A</sub> = 25°C unless otherwise specified

Characteristic	Symbol	Value	Unit
Peak Pulse Power Dissipation (Non repetitive current pulse derated above T <sub>A</sub> = 25° C) (Note 1)	P <sub>PK</sub>	600	W
Peak Power Derating Above 25°C	P <sub>der</sub>	4.8	W/°C
Peak Forward Surge Current, 8.3ms Single Half Sine Wave Superimposed on Rated Load (Notes 1, 2, & 3)	I <sub>FSM</sub>	100	A
Steady State Power Dissipation @ T <sub>L</sub> = 75°C	PM <sub>(AV)</sub>	5.0	W
Instantaneous Forward Voltage @ I <sub>PP</sub> = 35A (Notes 1, 2, & 3)	V <sub>F</sub>	V <sub>BR</sub> <100V	3.5
		V <sub>BR</sub> ≥100V	5.0
Operating Temperature Range	T <sub>j</sub>	-55 to +150	°C
Storage Temperature Range	T <sub>STG</sub>	-55 to +175	°C

- Notes:
1. Valid provided that terminals are kept at ambient temperature.
  2. Measured with 8.3ms single half sine-wave. Duty cycle = 4 pulses per minute maximum.
  3. Unidirectional units only.
  4. RoHS revision 13.2.2003. Glass and high temperature solder exemptions applied, see *EU Directive Annex Notes 5 and 7*.

Part Number Add C For Bi- Directional (Note 5)	Reverse Standoff Voltage $V_{RWM}$ (V)	Breakdown Voltage $V_{BR}$ @ $I_T$ (Note 6)		Test Current $I_T$ (mA)	Max. Reverse Leakage @ $V_{RWM}$ (Note 7) $I_R$ ( $\mu$ A)	Max. Clamping Voltage @ $I_{pp}$ $V_C$ (V)	Max. Peak Pulse Current $I_{pp}$ (A)	Marking Code	
		Min (V)	Max (V)					BI-	UNI-
See Note 4	$V_{RWM}$ (V)	Min (V)	Max (V)	$I_T$ (mA)	$I_R$ ( $\mu$ A)	$V_C$ (V)	(A)	BI-	UNI-
SMBJ5.0(C)A	5.0	6.40	7.23	10	800	9.2	65.2	AE	KE
SMBJ6.0(C)A	6.0	6.67	7.67	10	800	10.3	58.3	AG	KG
SMBJ6.5(C)A	6.5	7.22	8.30	10	500	11.2	53.6	AK	KK
SMBJ7.0(C)A	7.0	7.78	8.95	10	200	12.0	50.0	AM	KM
SMBJ7.5(C)A	7.5	8.33	9.58	1.0	100	12.9	46.5	AP	KP
SMBJ8.0(C)A	8.0	8.89	10.23	1.0	50	13.6	44.1	AR	KR
SMBJ8.5(C)A	8.5	9.44	10.82	1.0	10	14.4	41.7	AT	KT
SMBJ9.0(C)A	9.0	10.00	11.50	1.0	5.0	15.4	39.0	AV	KV
SMBJ10(C)A	10.0	11.10	12.80	1.0	5.0	17.0	35.3	AX	KX
SMBJ11(C)A	11.0	12.20	14.40	1.0	5.0	18.2	33.0	AZ	KZ
SMBJ12(C)A	12.0	13.30	15.30	1.0	5.0	19.9	30.2	BE	LE
SMBJ13(C)A	13.0	14.40	16.50	1.0	5.0	21.5	27.9	BG	LG
SMBJ14(C)A	14.0	15.60	17.90	1.0	5.0	23.2	25.8	BK	LK
SMBJ15(C)A	15.0	16.70	19.20	1.0	5.0	24.4	24.0	BM	LM
SMBJ16(C)A	16.0	17.80	20.50	1.0	5.0	26.0	23.1	BP	LP
SMBJ17(C)A	17.0	18.90	21.70	1.0	5.0	27.6	21.7	BR	LR
SMBJ18(C)A	18.0	20.00	23.30	1.0	5.0	29.2	20.5	BT	LT
SMBJ20(C)A	20.0	22.20	25.50	1.0	5.0	32.4	18.5	BV	LV
SMBJ22(C)A	22.0	24.40	28.00	1.0	5.0	35.5	16.9	BX	LX
SMBJ24(C)A	24.0	26.70	30.70	1.0	5.0	38.9	15.4	BZ	LZ
SMBJ26(C)A	26.0	28.90	33.20	1.0	5.0	42.1	14.2	CE	ME
SMBJ28(C)A	28.0	31.10	35.80	1.0	5.0	45.4	13.2	CG	MG
SMBJ30(C)A	30.0	33.30	38.30	1.0	5.0	48.4	12.4	CK	MK
SMBJ33(C)A	33.0	36.70	42.20	1.0	5.0	53.3	11.3	CM	MM
SMBJ36(C)A	36.0	40.00	46.00	1.0	5.0	58.1	10.3	CP	MP
SMBJ40(C)A	40.0	44.40	51.10	1.0	5.0	64.5	9.3	CR	MR
SMBJ43(C)A	43.0	47.80	54.90	1.0	5.0	69.4	8.6	CT	MT
SMBJ45(C)A	45.0	50.00	57.50	1.0	5.0	72.7	8.3	CV	MV
SMBJ48(C)A	48.0	53.30	61.30	1.0	5.0	77.4	7.7	CX	MX
SMBJ51(C)A	51.0	56.70	65.20	1.0	5.0	82.4	7.3	CZ	MZ
SMBJ54(C)A	54.0	60.00	69.00	1.0	5.0	87.1	6.9	DE	NE
SMBJ58(C)A	58.0	64.40	74.60	1.0	5.0	93.6	6.4	DG	NG
SMBJ60(C)A	60.0	66.70	76.70	1.0	5.0	96.8	6.2	DK	NK
SMBJ64(C)A	64.0	71.10	81.80	1.0	5.0	103.0	5.8	DM	NM
SMBJ70(C)A	70.0	77.80	89.50	1.0	5.0	113.0	5.3	DP	NP
SMBJ75(C)A	75.0	83.30	95.80	1.0	5.0	121.0	4.9	DR	NR
SMBJ78(C)A	78.0	86.70	99.70	1.0	5.0	126.0	4.7	DT	NT
SMBJ85(C)A	85.0	94.40	108.20	1.0	5.0	137.0	4.4	DV	NV
SMBJ90(C)A	90.0	100.0	115.50	1.0	5.0	146.0	4.1	DX	NX
SMBJ100(C)A	100.0	111.0	128.00	1.0	5.0	162.0	3.7	DZ	NZ
SMBJ110(C)A	110.0	122.0	140.00	1.0	5.0	177.0	3.4	EE	PE
SMBJ120(C)A	120.0	133.0	153.00	1.0	5.0	193.0	3.1	EG	PG
SMBJ130(C)A	130.0	144.0	165.50	1.0	5.0	209.0	2.9	EK	PK
SMBJ150(C)A	150.0	167.0	192.50	1.0	5.0	243.0	2.5	EM	PM
SMBJ160(C)A	160.0	178.0	205.00	1.0	5.0	259.0	2.3	EP	PP
SMBJ170(C)A	170.0	189.0	217.50	1.0	5.0	275.0	2.2	ER	PR

- Notes:
- Suffix C denotes Bi-directional device.
  - $V_{BR}$  measured with  $I_T$  current pulse = 300 $\mu$ s
  - For Bi-Directional devices having  $V_{RWM}$  of 10V and under, the  $I_R$  is doubled.

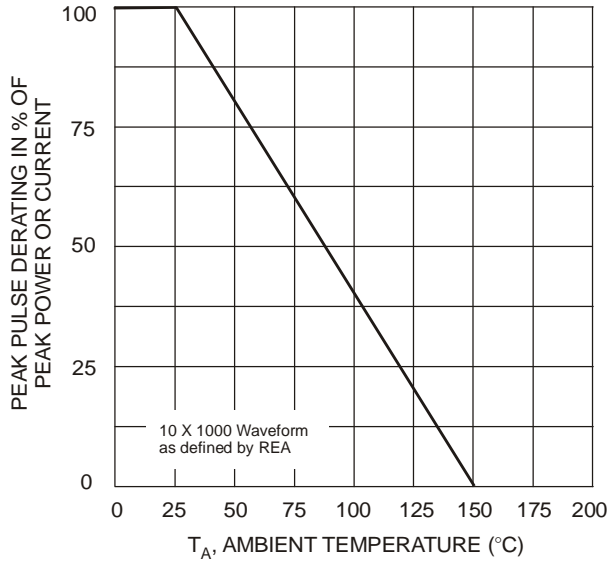

Fig. 1 Pulse Derating Curve

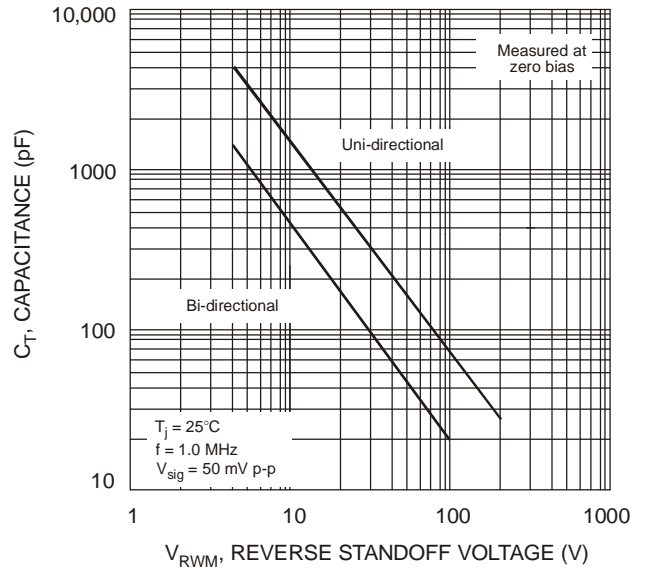

Fig. 2 Typical Total Capacitance

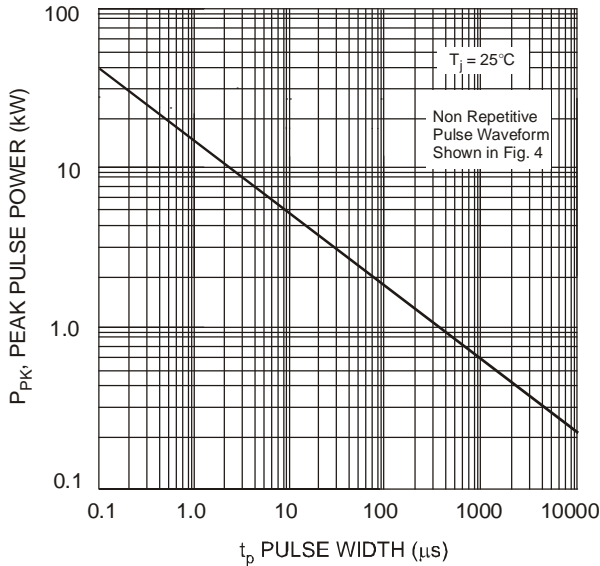

Fig. 3 Pulse Rating Curve

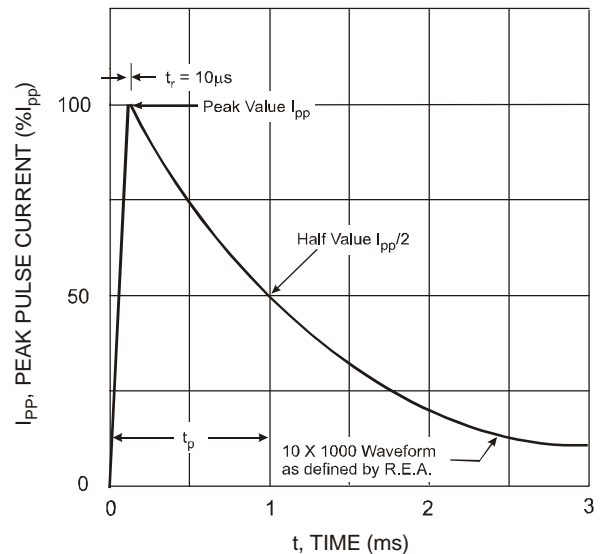

Fig. 4 Pulse Waveform

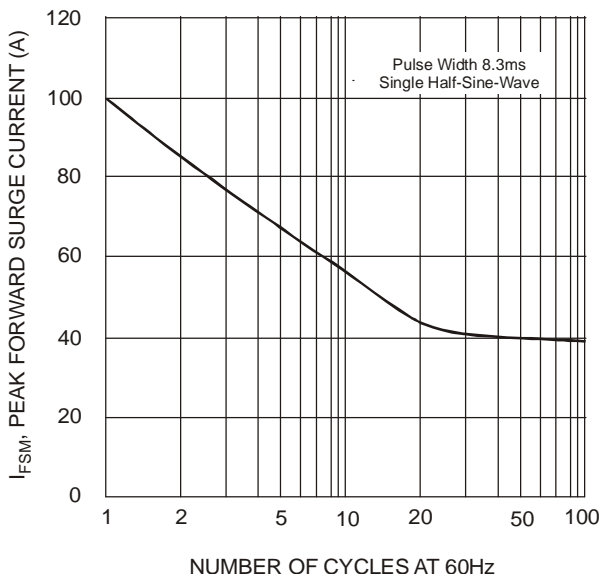

Fig. 5 Maximum Non-Repetitive Surge Current

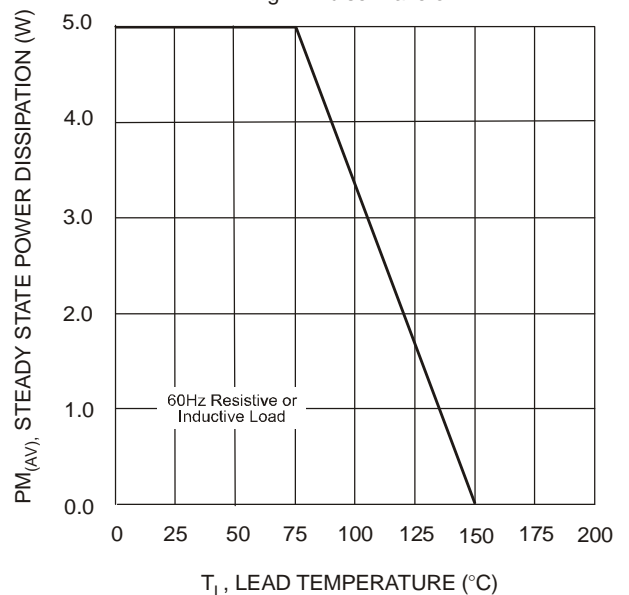

Fig. 6 Steady State Power Derating Curve

## Ordering Information (Note 8)

Device*	Packaging	Shipping
SMBJXXX(C)A-13-F	SMB	3000/Tape & Reel

Notes: 8. For packaging details, visit our website at <http://www.diodes.com/datasheets/ap02007.pdf>.

\*x = Device Voltage, e.g., SMBJ170A-13-F.

## Marking Information

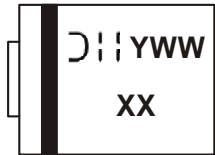

XX = Product type marking code (See Page 2)  
 D: = Manufacturers' code marking  
 YWW = Date code marking  
 Y = Last digit of year ex: 2 for 2002  
 WW = Week code 01 to 52

### IMPORTANT NOTICE

Diodes Incorporated and its subsidiaries reserve the right to make modifications, enhancements, improvements, corrections or other changes without further notice to any product herein. Diodes Incorporated does not assume any liability arising out of the application or use of any product described herein; neither does it convey any license under its patent rights, nor the rights of others. The user of products in such applications shall assume all risks of such use and will agree to hold Diodes Incorporated and all the companies whose products are represented on our website, harmless against all damages.

### LIFE SUPPORT

Diodes Incorporated products are not authorized for use as critical components in life support devices or systems without the expressed written approval of the President of Diodes Incorporated.