

Surface Mount TRANSZORB® Transient Voltage Suppressors



DO-214AC (SMA)

PRIMARY CHARACTERISTICS	
V _{WM}	5.0 V to 188 V
P _{PPM}	400 W, 300 W
I _{FSM}	40 A
T _J max.	150 °C

DEVICES FOR BI-DIRECTION APPLICATIONS

For bi-directional use C or CA suffix (e.g. SMAJ10C, SMAJ10CA).

Electrical characteristics apply in both directions.

FEATURES

- Low profile package
- Ideal for automated placement
- Glass passivated chip junction
- Available in uni-directional and bi-directional
- 400 W peak pulse power capability with a 10/1000 μs waveform, repetitive rate (duty cycle): 0.01 % (300 W above 78 V)
- Excellent clamping capability
- Very fast response time
- Low incremental surge resistance
- Meets MSL level 1, per J-STD-020C, LF max peak of 260 °C
- Solder dip 260 °C, 40 seconds
- Component in accordance to RoHS 2002/95/EC and WEEE 2002/96/EC



TYPICAL APPLICATIONS

Use in sensitive electronics protection against voltage transients induced by inductive load switching and lighting on ICs, MOSFET, signal lines of sensor units for consumer, computer, industrial, automotive and telecommunication.

MECHANICAL DATA

Case: DO-214AC (SMA)

Epoxy meets UL 94V-0 flammability rating

Terminals: Matte tin plated leads, solderable per J-STD-002B and JESD22-B102D

E3 suffix for commercial grade, HE3 suffix for high reliability grade (AEC Q101 qualified)

Polarity: Color band denotes cathode end

MAXIMUM RATINGS (T _A = 25 °C unless otherwise noted)			
PARAMETER	SYMBOL	VALUE	UNIT
Peak pulse power dissipation with a 10/1000 μs waveform ⁽¹⁾⁽²⁾ (Fig. 1)	P _{PPM}	400	W
Peak pulse current with a waveform ⁽¹⁾	I _{PPM}	See next table	A
Peak forward surge current 8.3 ms single half sine-wave uni-directional only ⁽²⁾	I _{FSM}	40	A
Operating junction and storage temperature range	T _J , T _{STG}	- 55 to + 150	°C

Notes:

(1) Non-repetitive current pulse, per Fig. 3 and derated above T_A = 25 °C per Fig. 2. Rating is 300 W above 78 V

(2) Mounted on 0.2 x 0.2" (5.0 x 5.0 mm) copper pads to each terminal



ELECTRICAL CHARACTERISTICS ($T_A = 25\text{ }^\circ\text{C}$ unless otherwise noted)									
DEVICE TYPE	DEVICE MARKING CODE		BREAKDOWN VOLTAGE V_{BR} AT I_T ⁽¹⁾ (V)		TEST CURRENT I_T (mA)	STAND-OFF VOLTAGE V_{WM} (V)	MAXIMUM REVERSE LEAKAGE AT V_{WM} I_D (μA) ⁽³⁾	MAXIMUM PEAK PULSE SURGE CURRENT I_{PPM} (A) ⁽²⁾	MAXIMUM CLAMPING VOLTAGE AT I_{PPM} V_C (V)
	UNI	BI	MIN	MAX					
SMAJ5.0	AD	WD	6.40	7.82	10	5.0	800	41.7	9.6
SMAJ5.0A ⁽⁵⁾	AE	WE	6.40	7.07	10	5.0	800	43.5	9.2
SMAJ6.0	AF	WF	6.67	8.15	10	6.0	800	35.1	11.4
SMAJ6.0A	AG	WG	6.67	7.37	10	6.0	800	38.8	10.3
SMAJ6.5	AH	WH	7.22	8.82	10	6.5	500	32.5	12.3
SMAJ6.5A	AK	WK	7.22	7.98	10	6.5	500	35.7	11.2
SMAJ7.0	AL	WL	7.78	9.51	10	7.0	200	30.1	13.3
SMAJ7.0A	AM	WM	7.78	8.60	10	7.0	200	33.3	12.0
SMAJ7.5	AN	WN	8.33	10.2	1.0	7.5	100	28.0	14.3
SMAJ7.5A	AP	WP	8.33	9.21	1.0	7.5	100	31.0	12.9
SMAJ8.0	AQ	WQ	8.89	10.9	1.0	8.0	50	26.7	15.0
SMAJ8.0A	AR	WR	8.89	9.83	1.0	8.0	50	29.4	13.6
SMAJ8.5	AS	WS	9.44	11.5	1.0	8.5	10	25.2	15.9
SMAJ8.5A	AT	WT	9.44	10.4	1.0	8.5	10	27.8	14.4
SMAJ9.0	AU	WU	10.0	12.2	1.0	9.0	5.0	23.7	16.9
SMAJ9.0A	AV	WV	10.0	11.1	1.0	9.0	5.0	26.0	15.4
SMAJ10	AW	WW	11.1	13.6	1.0	10	1.0	21.3	18.8
SMAJ10A	AX	WX	11.1	12.3	1.0	10	1.0	23.5	17.0
SMAJ11	AY	WY	12.2	14.9	1.0	11	1.0	19.9	20.1
SMAJ11A	AZ	WZ	12.2	13.5	1.0	11	1.0	22.0	18.2
SMAJ12	BD	XD	13.3	16.3	1.0	12	1.0	18.2	22.0
SMAJ12A	BE	XE	13.3	14.7	1.0	12	1.0	20.1	19.9
SMAJ13	BF	XF	14.4	17.6	1.0	13	1.0	16.8	23.8
SMAJ13A	BG	XG	14.4	15.9	1.0	13	1.0	18.6	21.5
SMAJ14	BH	XH	15.6	19.1	1.0	14	1.0	15.5	25.8
SMAJ14A	BK	XK	15.6	17.2	1.0	14	1.0	17.2	23.2
SMAJ15	BL	XL	16.7	20.4	1.0	15	1.0	14.9	26.9
SMAJ15A	BM	XM	16.7	18.5	1.0	15	1.0	16.4	24.4
SMAJ16	BN	XN	17.8	21.8	1.0	16	1.0	13.9	28.8
SMAJ16A	BP	XP	17.8	19.7	1.0	16	1.0	15.4	26.0
SMAJ17	BQ	XQ	18.9	23.1	1.0	17	1.0	13.1	30.5
SMAJ17A	BR	XR	18.9	20.9	1.0	17	1.0	14.5	27.6
SMAJ18	BS	XS	20.0	24.4	1.0	18	1.0	12.4	32.2
SMAJ18A	BT	XT	20.0	22.1	1.0	18	1.0	13.7	29.2
SMAJ20	BU	XU	22.2	27.1	1.0	20	1.0	11.2	35.8
SMAJ20A	BV	XV	22.2	24.5	1.0	20	1.0	12.3	32.4
SMAJ22	BW	XW	24.4	29.8	1.0	22	1.0	10.2	39.4
SMAJ22A	BX	XX	24.4	26.9	1.0	22	1.0	11.3	35.5
SMAJ24	BY	XY	26.7	32.6	1.0	24	1.0	9.3	43.0
SMAJ24A	BZ	XZ	26.7	29.5	1.0	24	1.0	10.3	38.9
SMAJ26	CD	YD	28.9	35.3	1.0	26	1.0	8.6	46.6
SMAJ26A	CE	YE	28.9	31.9	1.0	26	1.0	9.5	42.1
SMAJ28	CF	YF	31.1	38.0	1.0	28	1.0	8.0	50.0
SMAJ28A	CG	YG	31.1	34.4	1.0	28	1.0	8.8	45.4
SMAJ30	CH	YH	33.3	40.7	1.0	30	1.0	7.5	53.5
SMAJ30A	CK	YK	33.3	36.8	1.0	30	1.0	8.3	48.4
SMAJ33	CL	YL	36.7	44.9	1.0	33	1.0	6.8	59.0
SMAJ33A	CM	YM	36.7	40.6	1.0	33	1.0	7.5	53.3
SMAJ36	CN	YN	40.0	48.9	1.0	36	1.0	6.2	64.3
SMAJ36A	CP	YP	40.0	44.2	1.0	36	1.0	6.9	58.1
SMAJ40	CQ	YQ	44.4	54.3	1.0	40	1.0	5.6	71.4

ELECTRICAL CHARACTERISTICS ($T_A = 25\text{ }^\circ\text{C}$ unless otherwise noted)

DEVICE TYPE	DEVICE MARKING CODE		BREAKDOWN VOLTAGE V_{BR} AT I_T ⁽¹⁾ (V)		TEST CURRENT I_T (mA)	STAND-OFF VOLTAGE V_{WM} (V)	MAXIMUM REVERSE LEAKAGE AT V_{WM} I_D (μA) ⁽³⁾	MAXIMUM PEAK PULSE SURGE CURRENT I_{PPM} (A) ⁽²⁾	MAXIMUM CLAMPING VOLTAGE AT I_{PPM} V_C (V)
	UNI	BI	MIN	MAX					
SMAJ40A	CR	YR	44.4	49.1	1.0	40	1.0	6.2	64.5
SMAJ43	CS	YS	47.8	58.4	1.0	43	1.0	5.2	76.7
SMAJ43A	CT	YT	47.8	52.8	1.0	43	1.0	5.8	69.4
SMAJ45	CU	YU	50.0	61.1	1.0	45	1.0	5.0	80.3
SMAJ45A	CV	YV	50.0	55.3	1.0	45	1.0	5.5	72.7
SMAJ48	CW	YW	53.3	65.1	1.0	48	1.0	4.7	85.5
SMAJ48A	CX	YX	53.3	58.9	1.0	48	1.0	5.2	77.4
SMAJ51	CY	YY	56.7	69.3	1.0	51	1.0	4.4	91.1
SMAJ51A	CZ	YZ	56.7	62.7	1.0	51	1.0	4.9	82.4
SMAJ54	RD	ZD	60.0	73.3	1.0	54	1.0	4.2	96.3
SMAJ54A	RE	ZE	60.0	66.3	1.0	54	1.0	4.6	87.1
SMAJ58	RF	ZF	64.4	78.7	1.0	58	1.0	3.9	103
SMAJ58A	RG	ZG	64.4	71.2	1.0	58	1.0	4.3	93.6
SMAJ60	RH	ZH	66.7	81.5	1.0	60	1.0	3.7	107
SMAJ60A	RK	ZK	66.7	73.7	1.0	60	1.0	4.1	96.8
SMAJ64	RL	ZL	71.1	86.9	1.0	64	1.0	3.5	114
SMAJ64A	RM	ZM	71.1	78.6	1.0	64	1.0	3.9	103
SMAJ70	RN	ZN	77.8	95.1	1.0	70	1.0	3.2	125
SMAJ70A	RP	ZP	77.8	86.0	1.0	70	1.0	3.5	113
SMAJ75	RQ	ZQ	83.3	102	1.0	75	1.0	3.0	134
SMAJ75A	RR	ZR	83.3	92.1	1.0	75	1.0	3.3	121
SMAJ78	RS	ZS	86.7	106	1.0	78	1.0	2.9	139
SMAJ78A	RT	ZT	86.7	95.8	1.0	78	1.0	3.2	126
SMAJ85	RU	ZU	94.4	115	1.0	85	1.0	2.0	151
SMAJ85A	RV	ZV	94.4	104	1.0	85	1.0	2.2	137
SMAJ90	RW	ZW	100	122	1.0	90	1.0	1.9	160
SMAJ90A	RX	ZX	100	111	1.0	90	1.0	2.1	146
SMAJ100	RY	ZY	111	136	1.0	100	1.0	1.7	179
SMAJ100A	RZ	<td>111</td> <td>123</td> <td>1.0</td> <td>100</td> <td>1.0</td> <td>1.9</td> <td>162</td>	111	123	1.0	100	1.0	1.9	162
SMAJ110	VD	VD	122	149	1.0	110	1.0	1.5	196
SMAJ110A	SE	VE	122	135	1.0	110	1.0	1.7	177
SMAJ120	SF	VF	133	163	1.0	120	1.0	1.4	214
SMAJ120A	VG	VG	133	147	1.0	120	1.0	1.6	193
SMAJ130	SH	VH	144	176	1.0	130	1.0	1.3	231
SMAJ130A	VK	VK	144	159	1.0	130	1.0	1.4	209
SMAJ150	SL	VL	167	204	1.0	150	1.0	1.1	268
SMAJ150A	VM	VM	167	185	1.0	150	1.0	1.2	243
SMAJ160	SN	VN	178	218	1.0	160	1.0	1.0	287
SMAJ160A	SP	VP	178	197	1.0	160	1.0	1.2	259
SMAJ170	SQ	VQ	189	231	1.0	170	1.0	0.99	304
SMAJ170A	SR	VR	189	209	1.0	170	1.0	1.09	275
SMAJ188	ST	VT	209	255	1.0	188	1.0	0.90	344
SMAJ188A	SS	VS	209	231	1.0	188	1.0	0.91	328

Notes:

- (1) Pulse test: $t_p \leq 50\text{ ms}$
- (2) Surge current waveform per Fig. 3 and derate per Fig. 2
- (3) For bi-directional types having V_{WM} of 10 V and less, the I_D limit is doubled
- (4) All terms and symbols are consistent with ANSI/IEEE C62.35
- (5) For the bi-directional SMAJ5.0CA, the maximum V_{BR} is 7.25 V
- (6) $V_F = 3.5\text{ V}$ at $I_F = 25\text{ A}$ (uni-directional only)

THERMAL CHARACTERISTICS ($T_A = 25\text{ }^\circ\text{C}$ unless otherwise noted)			
PARAMETER	SYMBOL	VALUE	UNIT
Typical thermal resistance, junction to ambient ⁽¹⁾	$R_{\theta JA}$	120	$^\circ\text{C/W}$
Typical thermal resistance, junction to lead	$R_{\theta JL}$	30	$^\circ\text{C/W}$

Note:

(1) Mounted on minimum recommended pad layout

ORDERING INFORMATION (Example)				
PREFERRED P/N	UNIT WEIGHT (g)	PREFERRED PACKAGE CODE	BASE QUANTITY	DELIVERY MODE
SMAJ5.0A-E3/61	0.064	61	1800	7" diameter plastic tape and reel
SMAJ5.0A-E3/5A	0.064	5A	7500	13" diameter plastic tape and reel
SMAJ5.0AHE3/61 ⁽¹⁾	0.064	61	1800	7" diameter plastic tape and reel
SMAJ5.0AHE3/5A ⁽¹⁾	0.064	5A	7500	13" diameter plastic tape and reel

Note:

(1) Automotive grade AEC Q101 qualified

RATINGS AND CHARACTERISTICS CURVES

($T_A = 25\text{ }^\circ\text{C}$ unless otherwise noted)

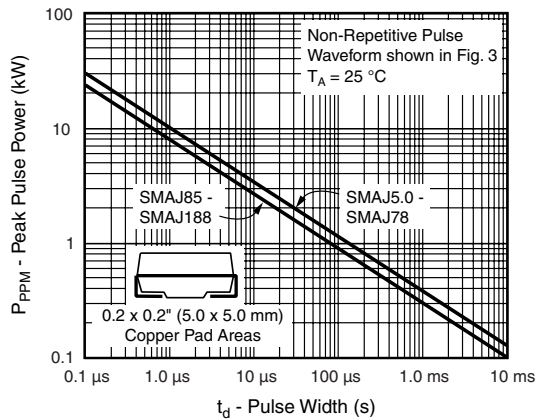

Figure 1. Peak Pulse Power Rating Curve

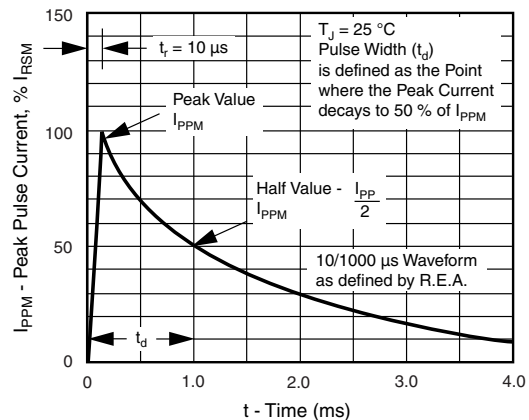

Figure 3. Pulse Waveform

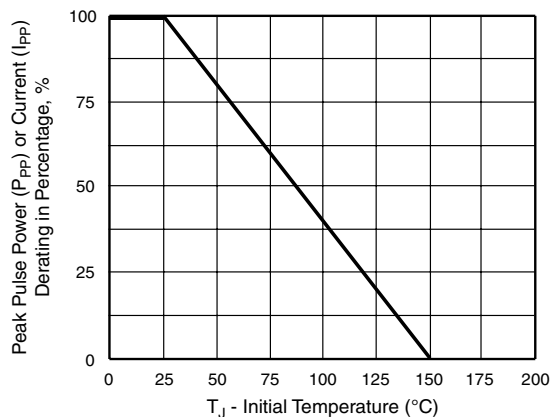

Figure 2. Pulse Power or Current vs. Initial Junction Temperature

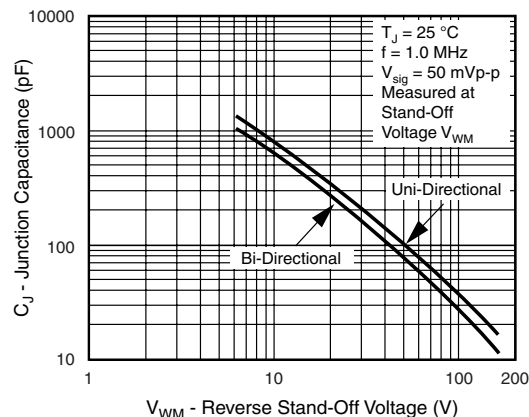

Figure 4. Typical Junction Capacitance

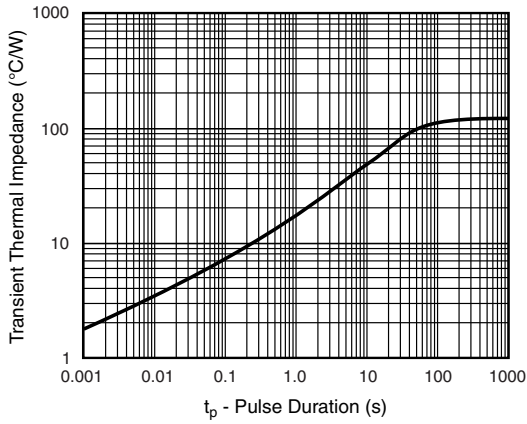

Figure 5. Typical Transient Thermal Impedance

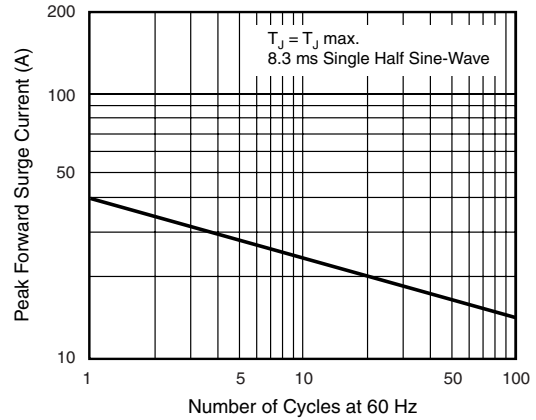
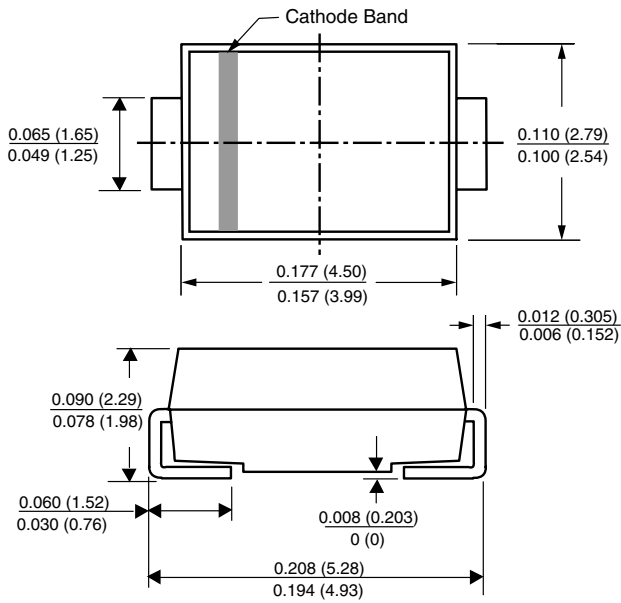

Figure 6. Maximum Non-Repetitive Forward Surge Current
Uni-Directional Only

PACKAGE OUTLINE DIMENSIONS in inches (millimeters)

DO-214AC (SMA)



Mounting Pad Layout

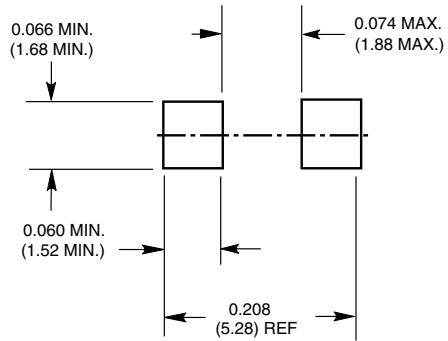



Disclaimer

All product specifications and data are subject to change without notice.

Vishay Intertechnology, Inc., its affiliates, agents, and employees, and all persons acting on its or their behalf (collectively, "Vishay"), disclaim any and all liability for any errors, inaccuracies or incompleteness contained herein or in any other disclosure relating to any product.

Vishay disclaims any and all liability arising out of the use or application of any product described herein or of any information provided herein to the maximum extent permitted by law. The product specifications do not expand or otherwise modify Vishay's terms and conditions of purchase, including but not limited to the warranty expressed therein, which apply to these products.

No license, express or implied, by estoppel or otherwise, to any intellectual property rights is granted by this document or by any conduct of Vishay.

The products shown herein are not designed for use in medical, life-saving, or life-sustaining applications unless otherwise expressly indicated. Customers using or selling Vishay products not expressly indicated for use in such applications do so entirely at their own risk and agree to fully indemnify Vishay for any damages arising or resulting from such use or sale. Please contact authorized Vishay personnel to obtain written terms and conditions regarding products designed for such applications.

Product names and markings noted herein may be trademarks of their respective owners.