

NZH series

Single Zener diodes

Rev. 01 — 27 January 2010

Product data sheet

1. Product profile

1.1 General description

General-purpose Zener diodes in a SOD123F small and flat lead Surface-Mounted Device (SMD) plastic package.

1.2 Features

- Total power dissipation: ≤ 500 mW
- Small plastic package suitable for surface-mounted design
- Wide working voltage range
- Low differential resistance

1.3 Applications

- General regulation functions

1.4 Quick reference data

Table 1. Quick reference data

Symbol	Parameter	Conditions	Min	Typ	Max	Unit
V_F	forward voltage	$I_F = 10$ mA	[1] -	-	0.9	V
P_{tot}	total power dissipation	$T_{amb} \leq 25$ °C	[2] -	-	500	mW
			[3] -	-	1	W



[1] Pulse test: $t_p \leq 300$ μ s; $\delta \leq 0.02$.

[2] Device mounted on an FR4 Printed-Circuit Board (PCB), single-sided copper, tin-plated, mounting pad for cathode 1 cm².

[3] Device mounted on a ceramic PCB, Al₂O₃, standard footprint.

2. Pinning information

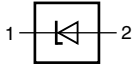
Table 2. Pinning

Pin	Description	Simplified outline	Graphic symbol
1	cathode	[1]	
2	anode		006aaa152

[1] The marking bar indicates the cathode.

3. Ordering information

Table 3. Ordering information

Type number	Package		
	Name	Description	Version
NZH3V0B to NZH30C[1]	-	plastic surface-mounted package; 2 leads	SOD123F

[1] The series consists of 25 types with nominal working voltages from 3.0 V to 30 V.

4. Marking

Table 4. Marking codes

Type number	Marking code	Type number	Marking code
NZH3V0B	CH	NZH10C	CW
NZH3V3A	CJ	NZH11C	CX
NZH3V6B	CK	NZH12B	CY
NZH3V9B	CL	NZH13B	D9
NZH4V3B	CM	NZH15B	D1
NZH4V7B	CN	NZH16C	D2
NZH5V1B	CP	NZH18C	D3
NZH5V6B	CQ	NZH20C	D4
NZH6V2B	CR	NZH22C	D5
NZH6V8B	CS	NZH24C	D6
NZH7V5C	CT	NZH27C	D7
NZH8V2B	CU	NZH30C	DA
NZH9V1B	CV	-	-

5. Limiting values

Table 5. Limiting values

In accordance with the Absolute Maximum Rating System (IEC 60134).

Symbol	Parameter	Conditions	Min	Max	Unit	
I_F	forward current		-	250	mA	
P_{tot}	total power dissipation	$T_{amb} \leq 25\text{ °C}$	[1]	-	500	mW
			[2]	-	1	W
T_j	junction temperature		-	150	°C	
T_{amb}	ambient temperature		-55	+150	°C	
T_{stg}	storage temperature		-65	+150	°C	

[1] Device mounted on an FR4 PCB, single-sided copper, tin-plated, mounting pad for cathode 1 cm².

[2] Device mounted on a ceramic PCB, Al₂O₃, standard footprint.

6. Thermal characteristics

Table 6. Thermal characteristics

Symbol	Parameter	Conditions	Min	Typ	Max	Unit	
$R_{th(j-a)}$	thermal resistance from junction to ambient	in free air	[1]	-	-	250	K/W
			[2]	-	-	125	K/W
$R_{th(j-sp)}$	thermal resistance from junction to solder point		[3]	-	-	70	K/W

[1] Device mounted on an FR4 PCB, single-sided copper, tin-plated, mounting pad for cathode 1 cm².

[2] Device mounted on a ceramic PCB, Al₂O₃, standard footprint.

[3] Soldering point of cathode tab.

7. Characteristics

Table 7. Characteristics

$T_j = 25\text{ °C}$ unless otherwise specified.

Symbol	Parameter	Conditions	Min	Typ	Max	Unit	
V_F	forward voltage	$I_F = 10\text{ mA}$	[1]	-	-	0.9	V

[1] Pulse test: $t_p \leq 300\text{ }\mu\text{s}$; $\delta \leq 0.02$.

Table 8. Characteristics per type; NZH3V0B to NZH10C

$T_j = 25\text{ °C}$ unless otherwise specified.

NZHxxx	Working voltage V_Z (V); $I_Z = 20\text{ mA}$		Maximum differential resistance r_{dif} (Ω)		Reverse current I_R (μA)		Diode capacitance C_d (pF) ^[1]
	Min	Max	$I_Z = 1\text{ mA}$	$I_Z = 20\text{ mA}$	Max	V_R (V)	Max
3V0B	2.85	3.15	1000	80	50	1	450
3V3A	3.16	3.38	1000	70	20	1	450
3V6B	3.42	3.78	1000	60	5	1	450
3V9B	3.71	4.10	1000	50	5	1	450

Table 8. Characteristics per type; NZH3V0B to NZH10C ...continued
T_j = 25 °C unless otherwise specified.

NZHxxx	Working voltage V _Z (V); I _Z = 20 mA		Maximum differential resistance r _{diff} (Ω)		Reverse current I _R (μA)		Diode capacitance C _d (pF) ^[1]
	Min	Max	I _Z = 1 mA	I _Z = 20 mA	Max	V _R (V)	Max
4V3B	4.17	4.43	1000	40	5	1	450
4V7B	4.55	4.80	900	25	5	1	300
5V1B	4.94	5.20	800	20	5	1.5	300
5V6B	5.45	5.73	500	13	5	2.5	300
6V2B	5.96	6.27	300	10	5	3	200
6V8B	6.49	6.83	150	8	2	3.5	200
7V5C	7.29	7.67	120	8	0.5	4	150
8V2B	8.02	8.36	120	8	0.5	5	150
9V1B	8.85	9.23	120	8	0.5	6	150
10C	9.70	10.20	120	8	0.2	7	90

[1] f = 1 MHz; V_R = 0 V

Table 9. Characteristics per type; NZH11C to NZH20C
T_j = 25 °C unless otherwise specified.

NZHxxx	Working voltage V _Z (V); I _Z = 10 mA		Maximum differential resistance r _{diff} (Ω)		Reverse current I _R (μA)		Diode capacitance C _d (pF) ^[1]
	Min	Max	I _Z = 1 mA	I _Z = 10 mA	Max	V _R (V)	Max
11C	10.82	11.38	120	10	0.04	8	85
12B	11.44	12.03	110	12	0.04	9	85
13B	12.35	13.65	110	14	0.04	10	80
15B	14.25	15.75	110	16	0.04	11	75
16C	15.69	16.51	150	18	0.04	12	75
18C	17.42	18.33	150	23	0.04	13	70
20C	19.23	20.22	200	28	0.04	15	60

[1] f = 1 MHz; V_R = 0 V

Table 10. Characteristics per type; NZH22C to NZH30C
T_j = 25 °C unless otherwise specified.

NZHxxx	Working voltage V _Z (V); I _Z = 5 mA		Maximum differential resistance r _{diff} (Ω)		Reverse current I _R (μA)		Diode capacitance C _d (pF) ^[1]
	Min	Max	I _Z = 1 mA	I _Z = 5 mA	Max	V _R (V)	Max
22C	21.08	22.17	200	30	0.04	17	60
24C	23.12	24.31	200	35	0.04	19	55
27C	25.63	26.95	250	45	0.04	21	50
30C	28.50	31.50	250	55	0.04	23	50

[1] f = 1 MHz; V_R = 0 V

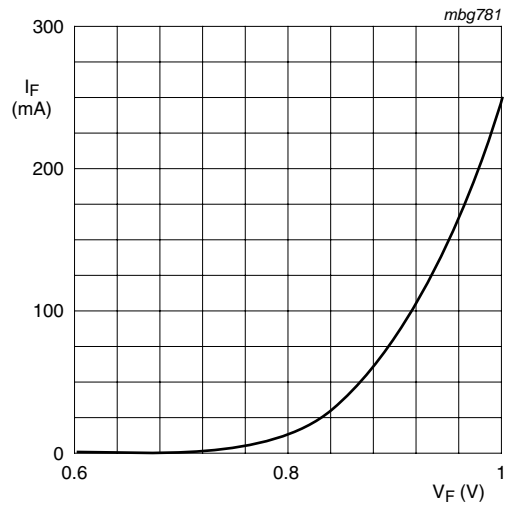

$T_j = 25\text{ }^\circ\text{C}$

Fig 1. Forward current as a function of forward voltage; typical values

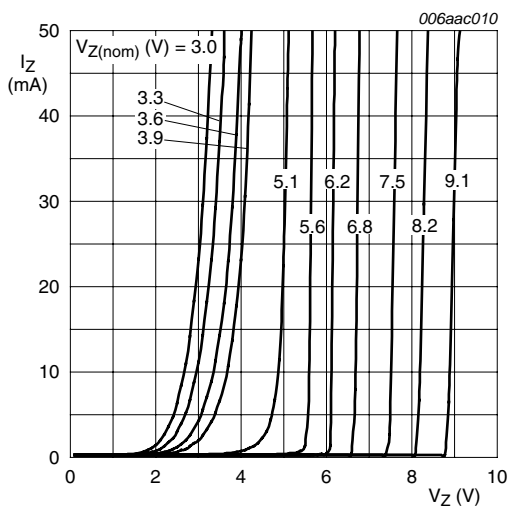

$T_j = 25\text{ }^\circ\text{C}$

Fig 2. Working current as a function of working voltage; typical values

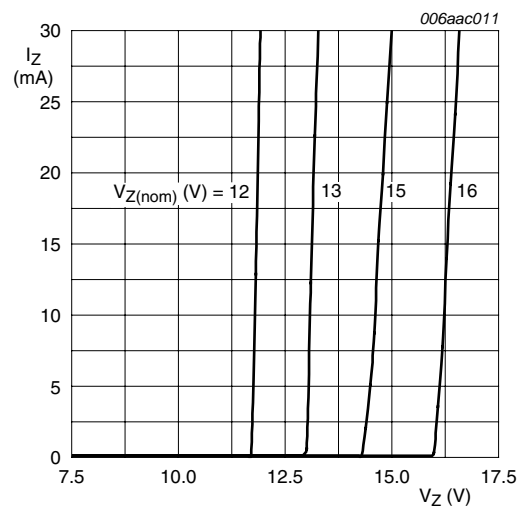

$T_j = 25\text{ }^\circ\text{C}$

Fig 3. Working current as a function of working voltage; typical values

8. Package outline

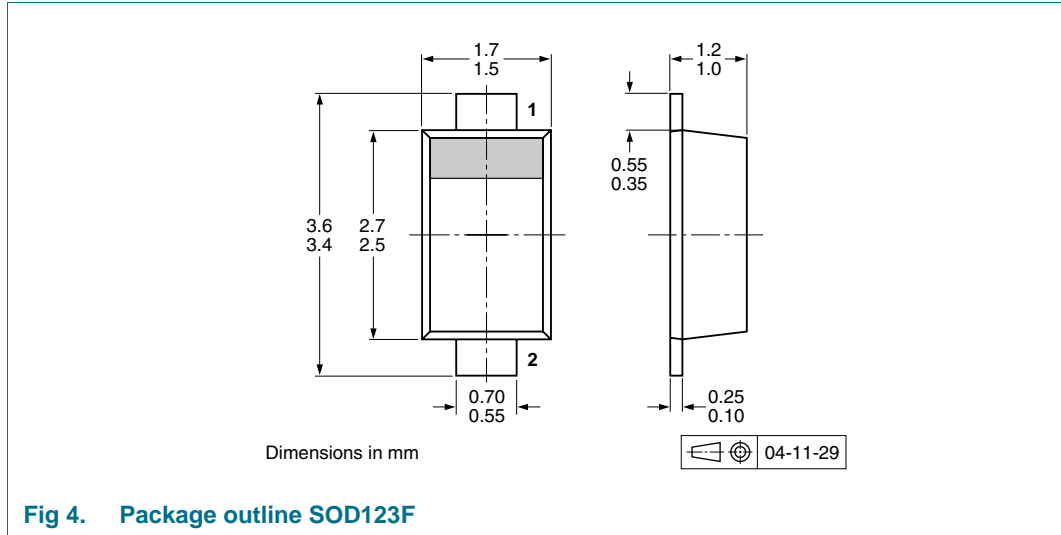

Fig 4. Package outline SOD123F

9. Packing information

Table 11. Packing methods

The indicated -xxx are the last three digits of the 12NC ordering code.^[1]

Type number	Package	Description	Packing quantity	
			3000	10000
NZH3V0B to NZH30C ^[2]	SOD123F	4 mm pitch, 8 mm tape and reel	-115	-135

[1] For further information and the availability of packing methods, see [Section 13](#).

[2] The series consists of 25 types with nominal working voltages from 3.0 V to 30 V.

10. Soldering

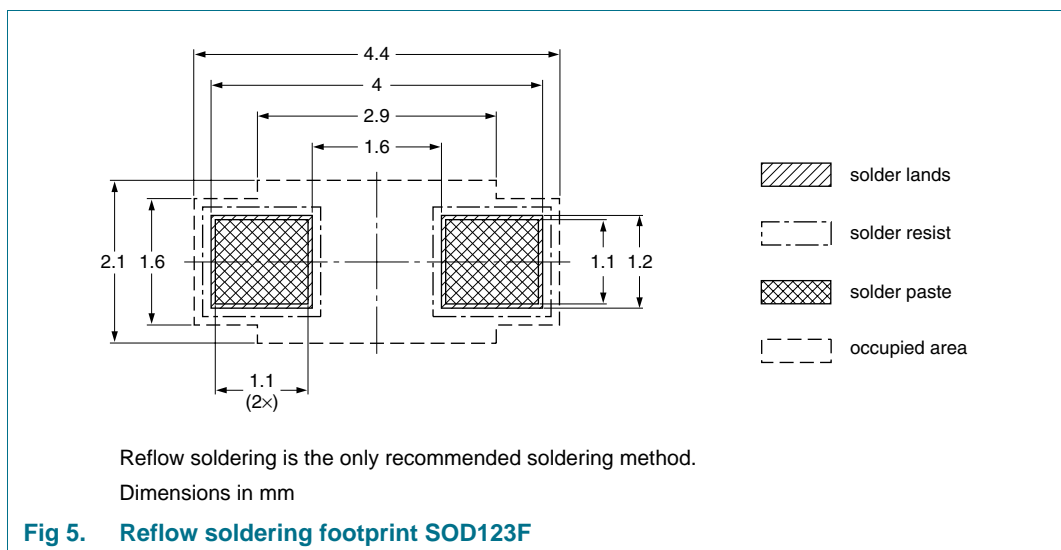

11. Revision history

Table 12. Revision history

Document ID	Release date	Data sheet status	Change notice	Supersedes
NZH_SER_1	20100127	Product data sheet	-	-

12. Legal information

12.1 Data sheet status

Document status ^{[1][2]}	Product status ^[3]	Definition
Objective [short] data sheet	Development	This document contains data from the objective specification for product development.
Preliminary [short] data sheet	Qualification	This document contains data from the preliminary specification.
Product [short] data sheet	Production	This document contains the product specification.

[1] Please consult the most recently issued document before initiating or completing a design.

[2] The term 'short data sheet' is explained in section "Definitions".

[3] The product status of device(s) described in this document may have changed since this document was published and may differ in case of multiple devices. The latest product status information is available on the Internet at URL <http://www.nxp.com>.

12.2 Definitions

Draft — The document is a draft version only. The content is still under internal review and subject to formal approval, which may result in modifications or additions. NXP Semiconductors does not give any representations or warranties as to the accuracy or completeness of information included herein and shall have no liability for the consequences of use of such information.

Short data sheet — A short data sheet is an extract from a full data sheet with the same product type number(s) and title. A short data sheet is intended for quick reference only and should not be relied upon to contain detailed and full information. For detailed and full information see the relevant full data sheet, which is available on request via the local NXP Semiconductors sales office. In case of any inconsistency or conflict with the short data sheet, the full data sheet shall prevail.

12.3 Disclaimers

General — Information in this document is believed to be accurate and reliable. However, NXP Semiconductors does not give any representations or warranties, expressed or implied, as to the accuracy or completeness of such information and shall have no liability for the consequences of use of such information.

Right to make changes — NXP Semiconductors reserves the right to make changes to information published in this document, including without limitation specifications and product descriptions, at any time and without notice. This document supersedes and replaces all information supplied prior to the publication hereof.

Suitability for use — NXP Semiconductors products are not designed, authorized or warranted to be suitable for use in medical, military, aircraft, space or life support equipment, nor in applications where failure or malfunction of an NXP Semiconductors product can reasonably be expected to result in personal injury, death or severe property or environmental

damage. NXP Semiconductors accepts no liability for inclusion and/or use of NXP Semiconductors products in such equipment or applications and therefore such inclusion and/or use is at the customer's own risk.

Applications — Applications that are described herein for any of these products are for illustrative purposes only. NXP Semiconductors makes no representation or warranty that such applications will be suitable for the specified use without further testing or modification.

Limiting values — Stress above one or more limiting values (as defined in the Absolute Maximum Ratings System of IEC 60134) may cause permanent damage to the device. Limiting values are stress ratings only and operation of the device at these or any other conditions above those given in the Characteristics sections of this document is not implied. Exposure to limiting values for extended periods may affect device reliability.

Terms and conditions of sale — NXP Semiconductors products are sold subject to the general terms and conditions of commercial sale, as published at <http://www.nxp.com/profile/terms>, including those pertaining to warranty, intellectual property rights infringement and limitation of liability, unless explicitly otherwise agreed to in writing by NXP Semiconductors. In case of any inconsistency or conflict between information in this document and such terms and conditions, the latter will prevail.

No offer to sell or license — Nothing in this document may be interpreted or construed as an offer to sell products that is open for acceptance or the grant, conveyance or implication of any license under any copyrights, patents or other industrial or intellectual property rights.

Export control — This document as well as the item(s) described herein may be subject to export control regulations. Export might require a prior authorization from national authorities.

Quick reference data — The Quick reference data is an extract of the product data given in the Limiting values and Characteristics sections of this document, and as such is not complete, exhaustive or legally binding.

12.4 Trademarks

Notice: All referenced brands, product names, service names and trademarks are the property of their respective owners.

13. Contact information

For more information, please visit: <http://www.nxp.com>

For sales office addresses, please send an email to: salesaddresses@nxp.com

14. Contents

1	Product profile	1
1.1	General description	1
1.2	Features	1
1.3	Applications	1
1.4	Quick reference data	1
2	Pinning information	2
3	Ordering information	2
4	Marking	2
5	Limiting values	3
6	Thermal characteristics	3
7	Characteristics	3
8	Package outline	6
9	Packing information	6
10	Soldering	6
11	Revision history	7
12	Legal information	8
12.1	Data sheet status	8
12.2	Definitions	8
12.3	Disclaimers	8
12.4	Trademarks	8
13	Contact information	8
14	Contents	9

Please be aware that important notices concerning this document and the product(s) described herein, have been included in section 'Legal information'.



© NXP B.V. 2010.

All rights reserved.

For more information, please visit: <http://www.nxp.com>

For sales office addresses, please send an email to: salesaddresses@nxp.com

Date of release: 27 January 2010

Document identifier: NZH_SER_1