

# Wire-wound Surface Mount Small Inductors For Signal Lines And DC Power Lines

## NL/NLV, NLC/NLCV, NLFC/NLFV series

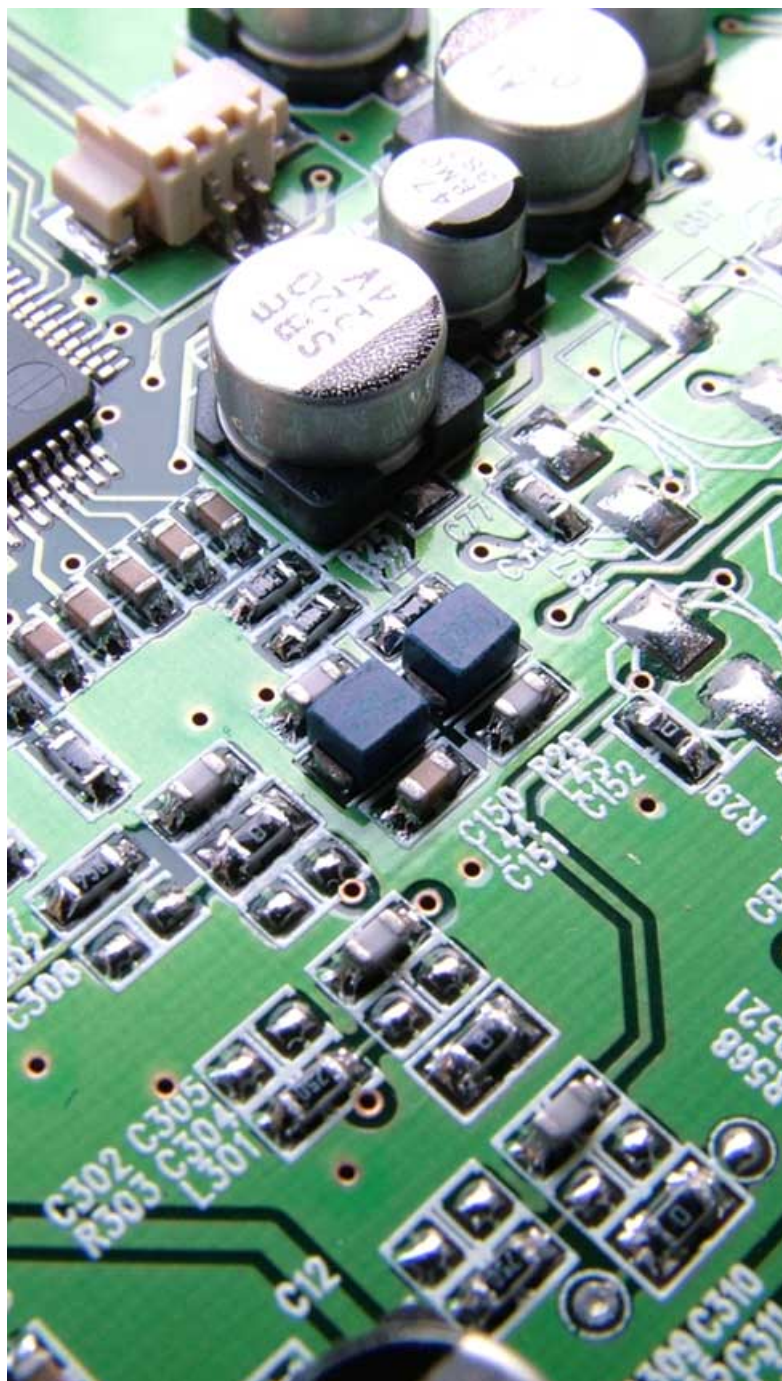

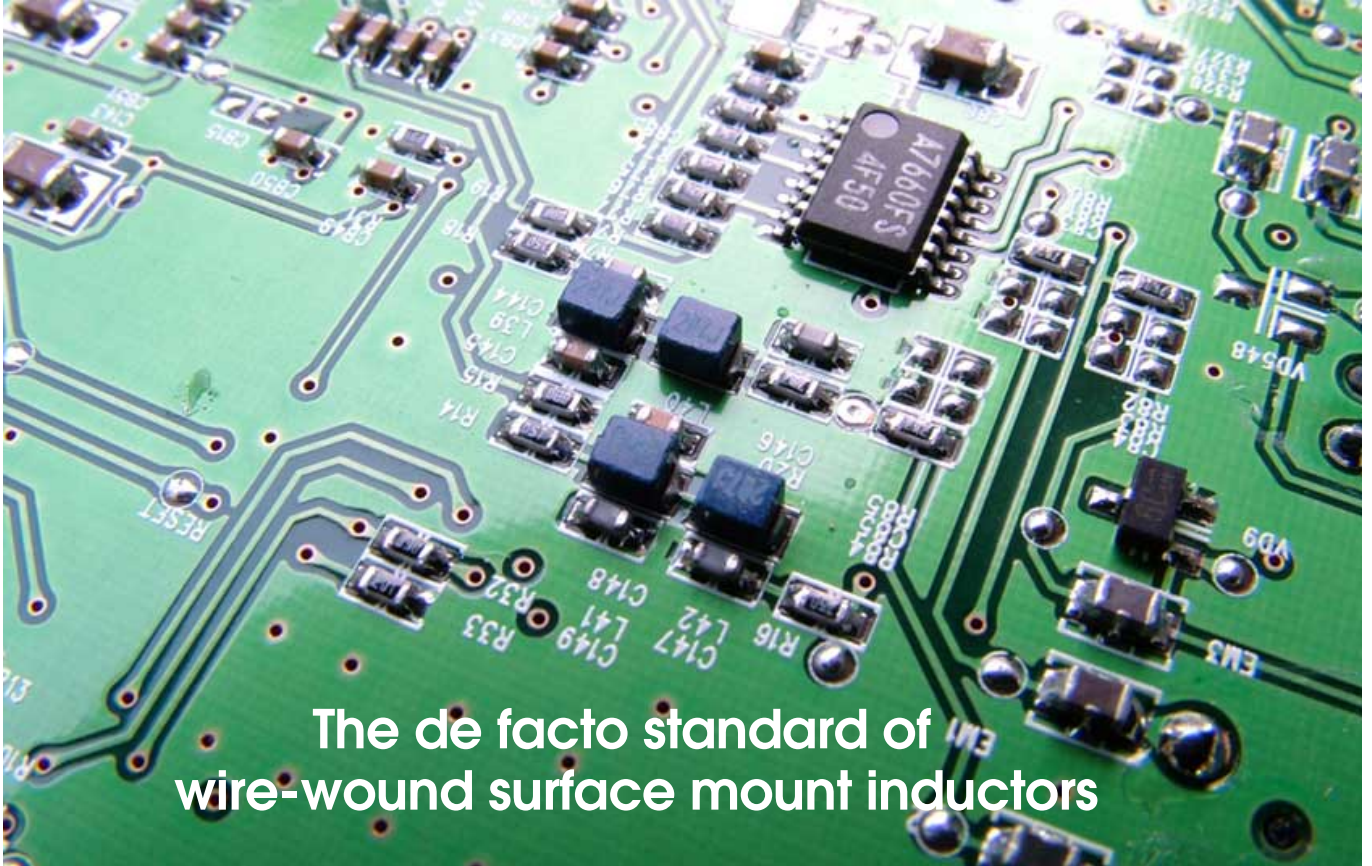



The de facto standard of wire-wound surface mount inductors



### Comparison of characteristic tendencies 1

Comparative example of representative products of L2.5 x W2.0 x T1.8 mm

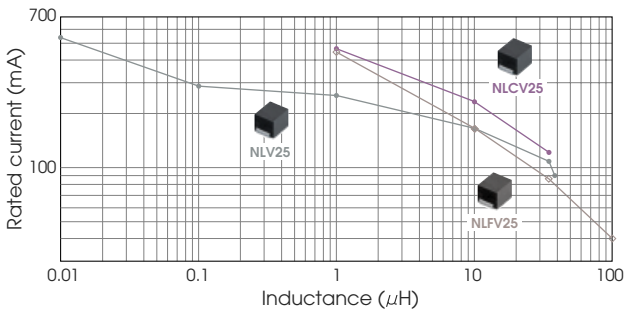

Wire-wound  
Surface Mount  
Small Inductors  
For Signal Lines  
And DC Power Lines

NL/NLV,  
NLC/NLCV,  
NLFC/NLFV  
series

### Comparison of characteristic tendencies 2

Comparative example of representative products of L2.5 x W2.0 x T1.8 mm

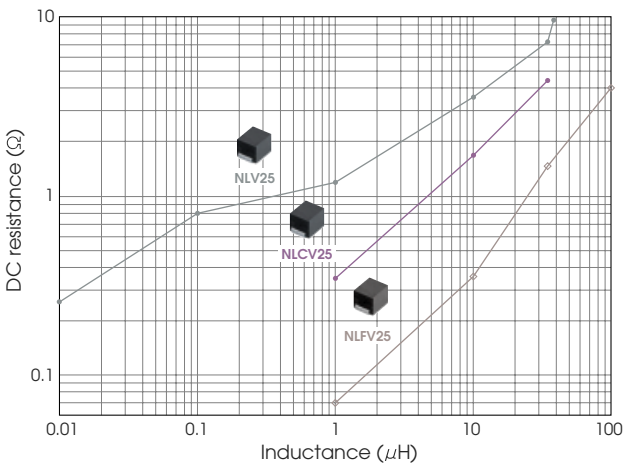

The NL family of products have been expanded in variety through a system which quickly responds to needs since the development of NL453232 (in the year 1981), which was optimized for the filter circuits of AV devices. The family continues to improve its world-wide reputation through its cumulative production total of over 34 billion units\*, with three characteristic groups and four shapes covering 0.01-10000 μH.

With its original reliability-possessing structural design, and excellent cost performance via its original, automated, mass production line – which was the world's first built line of this kind – the products' two advantages are the backbone of reliability and an outstanding adaptation achievement.

Also, in order to respond to ever-increasing global needs, the NL series continues to develop new technologies by greatly reducing Rdc and shifting to resin materials for reduced environmental burdens, or by improving production processes.

Among the following three characteristic types, the series with a "V" suffix are the latest achievements. Replacement has been underway continuously, starting from the shapes with the greatest versatility.



Three characteristic groups respond to diverse circuit design needs

NL/NLV series : A total of 155 products were made in a series of four shapes with high Q-characteristics in the high-frequency region for filtering signal lines, covering 0.01-10000 μH, with a narrow tolerance of ±5% using the E12 series.

NLC/NLCV series : Developed for the chokes of DC power lines. In four shapes, a total of 97 products are lined up, achieving 1.5 - 2 times larger current capacity than the same shape NL/NLV series with the originally developed high Bs, high μ ferrite core, and optimized windings.

NLFC/NLFV series : Responding to the need for making low loss power line chokes. A great reduction of Rdc was achieved using the original magnetic mold resin mixed with ferrite particles. With three versatile shapes, a total of 48 products are included in the line.

All products conform to the RoHS Directive.\*\*

\* 1982.12 - 2006.12

\*\* Conformity to RoHS Directive: This means that, in conformity with EU Directive 2002/95/EC, lead, cadmium, mercury, hexavalent chromium, and specific bromine-based flame retardants, PBB and PBDE, have not been used, except for exempted applications.



Three characteristic categories support the optimized design of diverse devices. The NL family's original technologies and superior advantages are incorporated in all of them.

TDK has developed super-small drum-shaped cores allowing the best balance between winding diameter and number of windings by utilizing its original magnetic path analytical simulation reinforced with significant accumulated data. In addition to this, the original high  $\mu$ -high B ferrite material is used to expand the NL family of products beginning with the NL series.

The structure directly integrating ferrite cores with processed winding ends and metal terminals is another original technological advance, confirming the advantages of the family in size and low loss. Moreover, building an automated manufacturing system that can control the center location when mounting the coils

to metal terminals to an accuracy of  $\pm$  a several tens  $\mu\text{m}$ , a mass-production system was early established for the industry's smallest 2016 products, supporting cost-saving and the downsizing of devices.

Also, to respond to the requests for battery-driven small, mobile device designs with reduced power consumption, the Rdc values of conventional choke products were improved by as much as 50-20% using a high-efficiency closed-magnetic path structure (practical reinforcement of  $\mu$ ), where high  $\mu$  ferrite particles of superior magnetic flux convergence are spread over the mold material covering the coils. The NL family remains at the industry's top level in terms of power saving effect.

Wide L-value range  
High Q  
Narrow tolerances  
For signal lines  
NL / NLV



Application example of digital TV tuner and tuner IC signal lines

Superb characteristic optimal for filtering and matching purposes

- Industry's top-notch high-frequency high-Q characteristic
- Covering 0.01-10000  $\mu\text{H}$  with four shapes
- E12 series, tolerance of  $\pm 5\%$  was standardized

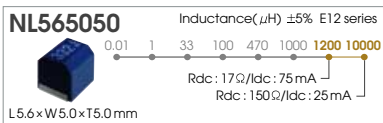
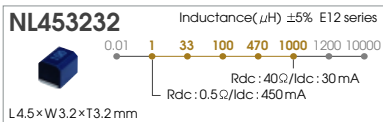
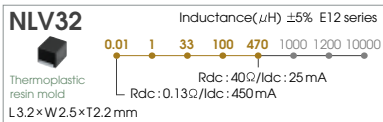
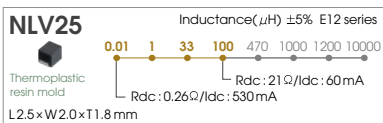

Application example of Analogue TV tuner (Analogue video signal input lines)

Large current choke  
For power lines  
NLC/NLCV



Application example of ATA-compatible HDD and HDD controller VDD line

World standard SMD choke for power lines

- Realizing 1.5 - 2 times larger electric current capacity than NL/NLV
- Covering 0.15-1000  $\mu\text{H}$  with four shapes
- Established a cutting-edge low-cost mass production system

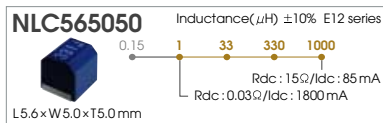
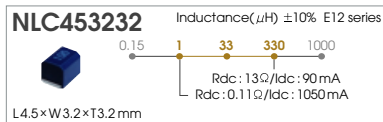
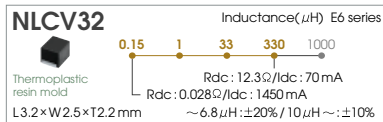
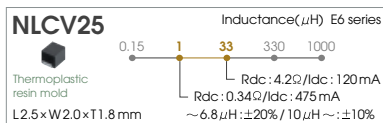

Application example of Car navigation system (DC power line)

Low Rdc choke  
For power lines  
NLFV/NLFC



Application example of digital still camera and Vcc line

Power-saving choke with maximized low-Rdc

- Reduced Rdc of NLC/NLCV by 50-20%
- Compatible with 1-1000  $\mu\text{H}$  with three downsized shapes
- Optimal for the power lines of handy devices

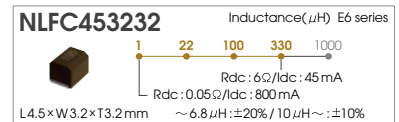
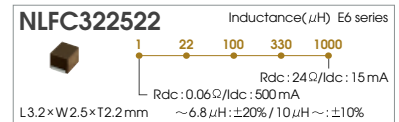
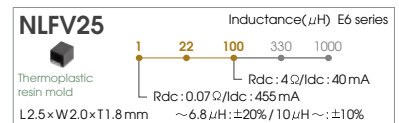

Actual example where a low-loss advantage is utilized in signal lines.



Potable CD player/Audio output line (Configuring LFP)

Wire-wound Surface Mount Small Inductors  
For Signal Lines And DC Power Lines

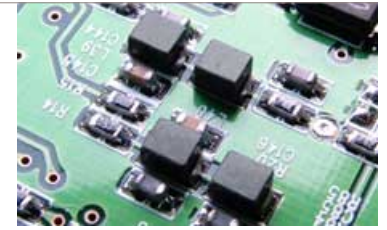

Expansion of product variety  
and downsizing complying  
with increased circuit design needs

NL/NLV, NLC/NLCV,  
NLFC/NLFCV series

The first NL was included in a TV tuner in 1981.

NL has also evolved with the remarkable technological evolution since then.

The onslaught of digitization coincides with the surface implementation of analog circuits. New portable devices have been repeatedly launched. Accelerated downsizing and thinning have grown. Rapidly increased powersaving needs are everywhere. There are myriad successful electronic devices for auto-mobiles. The evolution of home information appliances continues. And all of this with designs that recognize the sensitivity of the environment to the

toxicity of materials. Although these trends, in retrospect, are themselves mind-boggling technological evolutions, it was the circuit design needs that were the driving force in making the NL family what it is today.

"A product lineup that correspond to the latest circuit design needs right away" — has been the unchanged development creed of the NL family since the commencement of its technological efforts.

TV tuner	LD player	Portable CD player	Notebook PC	Cellular phone	Digital video camera	ADSL modem
Home VCR, Video camera		Portable video camera	Printer	MD player		DVD video recorder
Word processor, PC	CD player	LCD TV(TV tuner)	ISDN(DSU)	CS/BS tuner		CS digital broadcasting tuner
HDD Fax machine	Video game machine	Car CD player	Cordless phone			Car navigation system for VICS
Portable tape-recorder		DAT player	GPS car navigation system			HDD/DVD car navigation system
Car audio	CATV tuner	DAT recorder	High-definition television			DVD player
						DVD car navigation system
						Plasma TV, Large-scale LCD TV(TV tuner)
						Multi-display for car

Analog circuit >> For signal matching and various filter circuits >> Responding to low Rdc and downsizing needs >>

Seeking environmental responsiveness and small, rationalized structures >>

Digital circuit >> Countermeasures for decoupling and power line EMI >> Responding to large current, low Rdc, and downsizing needs >>

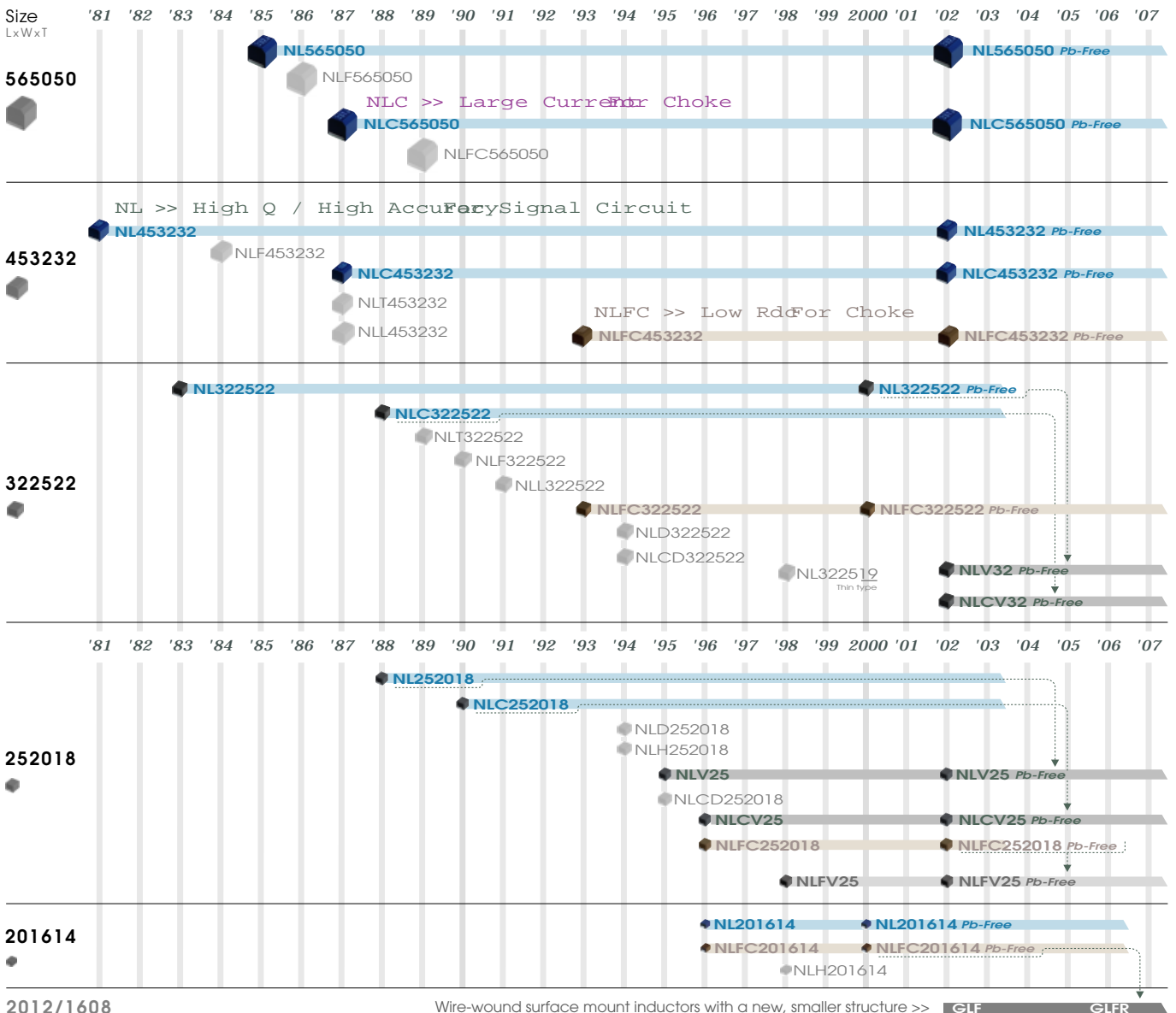

2012/1608

Wire-wound surface mount inductors with a new, smaller structure >>



**TDK's original rational production line was the world's first. Now, the NL family is making an effort to switch to further simplification of resource-saving automated production lines.**

The molding processes shown on the bottom right are the conventional processes using thermosetting resin.

A new molding process shown on the bottom left deletes processes such as "thermosetting promotion", "omitting burrs", and "smoothing processes" from these conventional processes and uses thermoplastic resin which can be collected and reused. With a process design skillfully utiliz-

ing the physical properties of this resin, which allows the control of viscosity through temperature control, a fully automated production line was built.

The series with the "V" suffix in its title is the new product type from this line. Shifting to the new product type is underway in order to respond to cost-saving needs and for maximized environmental conservation.

**Internal structure**

TDK's original design know-how is integrated in the structure as well. For example, an examination of the drawing point of the windings: 360 degrees is useful. It can be drawn from any angle and inductance value configurations performed, which are delicate and subtle with much freedom and precision. Also, simple yet sophisticated original know-how, such as a method of unifying the sides of drum cores, winding ends, and connection terminals, and a shape design for connection terminals seeking implementation reliability, are integrated everywhere.

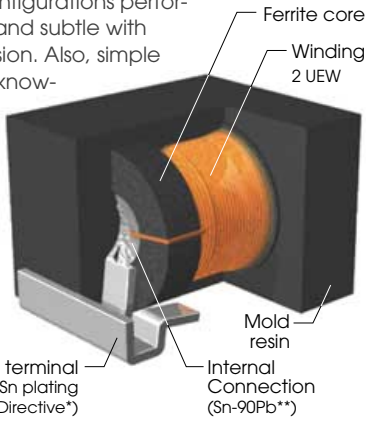

\* Conformity to RoHS Directive: This means that, in conformity with EU Directive 2002/95/EC, lead, cadmium, mercury, hexavalent chromium, and specific bromine-based flame retardants, PBB and PBDE, have not been used, except for exempted applications.  
 \*\* High-melting solder conforming to the RoHS Directive exemption application regulation

**Production process**

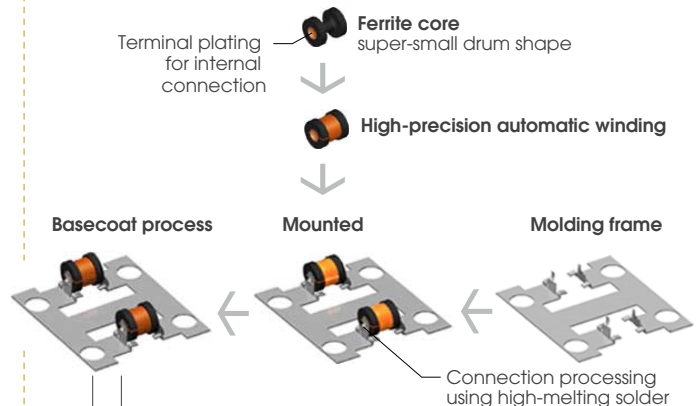

**Thermosetting resin mold product types**

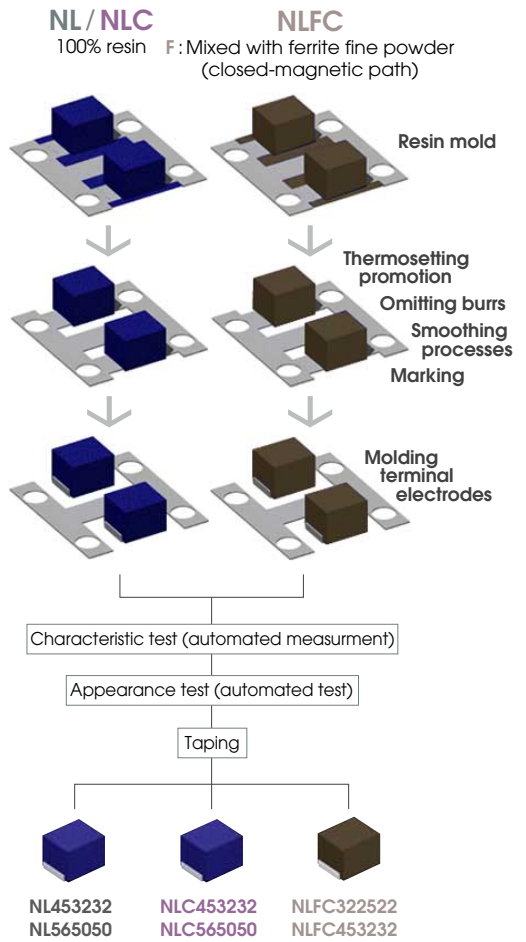

**Thermoplastic resin mold product types**

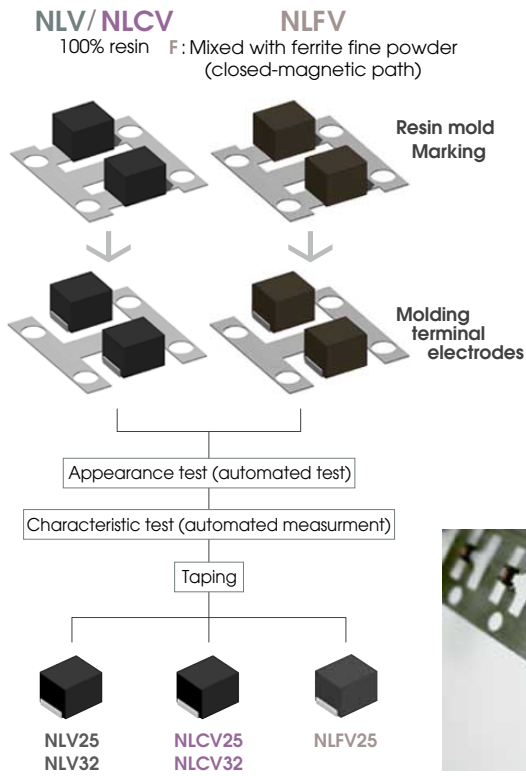

- Wide L-value range  
High Q  
Narrow tolerances  
For signal lines  
**NL / NLV**
- Large current choke  
For power lines  
**NLC / NLCV**
- Low Rdc choke  
For power lines  
**NLFC / NLFV**





## Wire-wound Surface Mount Small Inductors For Signal Lines And DC Power Lines



**Latest series  
development concept  
Industry's first efforts**

**NL/NLV, NLC/NLCV,  
NLFC/NLFV  
series**

### Original low-Rdc structure using magnetic particle compound resin

#### NLFC series

For the NLFC series, which responds to low-Rdc needs with unprecedented effectiveness, TDK's original inductance characteristic reinforcement measure is taken where mixing ferrite particles with formed mold resin optimizes the material properties and shapes of the drum-shaped cores.



Adding ferrite particles, a magnetic element, to the mold resin adhering to both sides of the drum core, and covering the whole coil body, a closed magnetic path structure equivalent to the coil with the pot-shaped core was realized. As a result, the magnetic flux occurring on the coil is reinforced, offering a similar inductance value to the same shape conventional product molded with non-magnetic resin, without enlarging its core shape in a coil of a larger diameter (smaller number of windings).

### Establishing the industry's first resource-saving and waste-free consistent production line

#### NLV,NLCV,NLFV series

Thermosetting resin, which has been widely used, has the disadvantage of generating unrecycleable waste materials (runners, burrs on the gates, etc.) resulting from pro-

duction processes. These have been collected and disposed of, so creating an environmental burden.

On the other hand, thermoplastic resin, because of its physical properties, is easy to collect and reuse, allowing recycling of all runner parts, which comprises a large quantity of the material, eradicating unwanted burrs by optimizing viscosity control. Also, by skillfully utilizing the advantages of thermoplastic resin, allowing reversible control of viscosity through temperature control, the leadtimes of conventional production lines can be greatly reduced when thermosetting resin is used.

In developing the NLV, NLCV, and NLFV series, new processing methods and process control technologies were developed to make full use of the advantages of thermoplastic resin. A high efficiency, consistent, production line was built which permitted a great reduction in production leadtime and increased power-saving, not to mention the ability to recycle the runner part.

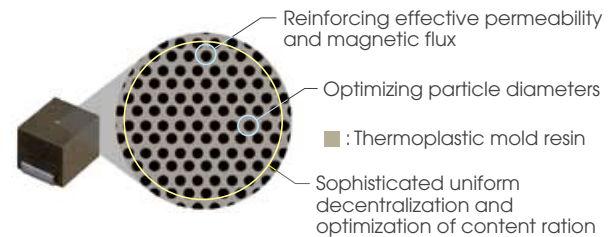

Also, as shown in the model above, for the NLFV series, characteristic improvements, such as magnetic characteristic reinforcement of ferrite particles, and optimization of particle diameter and mix ratio, were promoted, realizing further reduction of Rdc while maintaining compatibility with the early series (NLFC) in major characteristics and shape.

### Comparison of mold resins

Series	NL  NLC	NLV  NLCV	NLFC	NLFV
Mold resin	Thermosetting resin	Thermoplastic resin	Thermosetting resin + Ferrite particles	Thermoplastic resin + Ferrite particles
Resin color	Blue	Black	Brown	Dark brown
Marking	Print	Laser print or no print	Print	No print

### Structural common specification

Core material : Ferrite

Winding : 2 UEW

Internal connection : Soldering (Sn-90Pb\*)

Connection terminals : Copper alloy

Coating of connection terminals : Sn (lead-free)

Characteristic measurement : Automated total measurement

Appearance test : Visual examination (total inspection)

\* High-melting solder conforming to the RoHS Directive exemption application regulation)

NL's four shapes are virtually the de facto standard of resin mold fixed small inductors.

Although the shape design is the de facto standard, TDK's original technologies and know-how are integrated in the internal structure. In short, inductance ranges configured for each three characteristic groups are available in the industry's smallest class shapes. Smaller shapes and better frequency characteristics than competitors' products are found when used with the same inductance value.

All products are also compatible with flow processes at 260°C peak temperatures, not to mention the lead-free high-temperature reflow process, achieving the industry's top level in terms of implementation reliability.

Shapes and dimensions  
 Recommended PC board pattern

NL565050 NLC565050

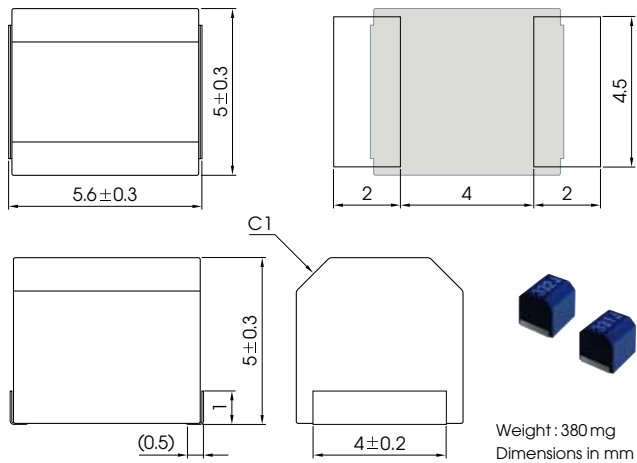

NL453232 NLC453232 NLFC453232

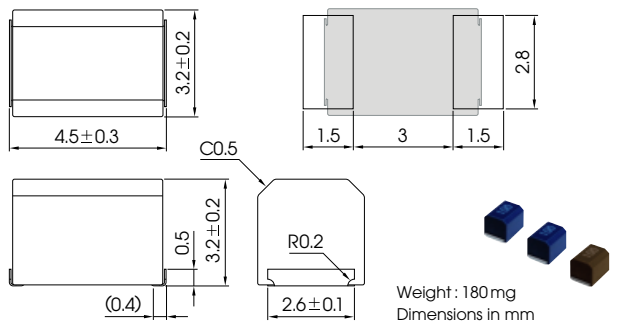

NLV32 NLCV32 NLFC322522

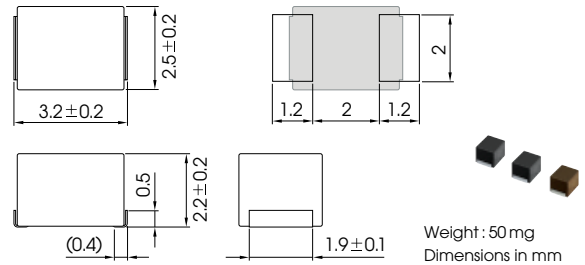

- Wide L-value range  
 High Q  
 Narrow tolerances  
 For signal lines  
**NL / NLV**
- Large current choke  
 For power lines  
**NLC / NLCV**
- Low Rdc choke  
 For power lines  
**NLFC / NLFV**

NLV25 NLCV25 NLFV25

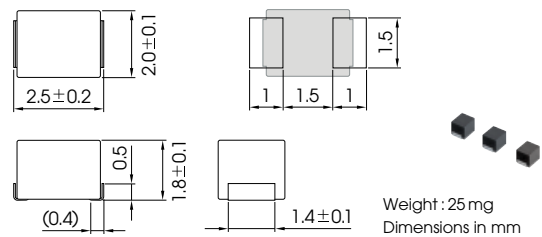

Recommended soldering conditions

Lead-free solder  
 High-temperature reflow process

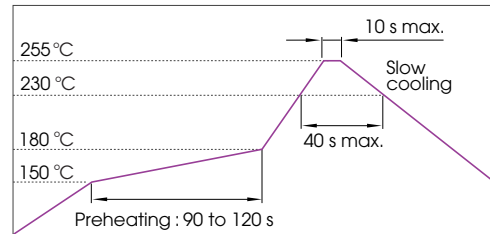



Wire-wound Surface Mount Small Inductors  
For Signal Lines And DC Power Lines

NL/NLV, NLC/NLCV,  
NLFC/NLFB series

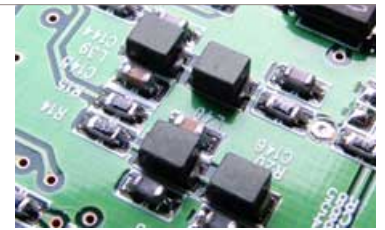

Application examples

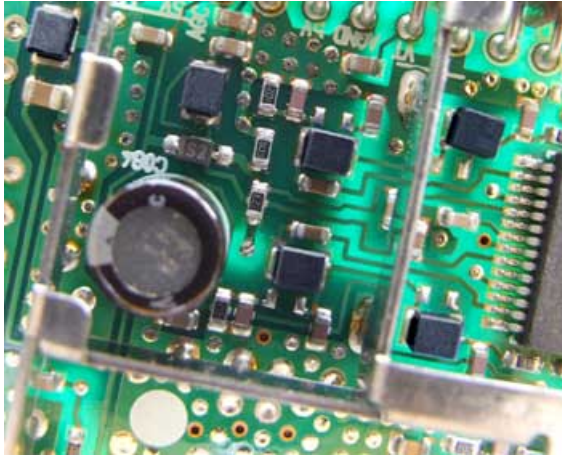

**DIGITAL TV TUNER**

Signal lines of tuner ICs and DC power lines

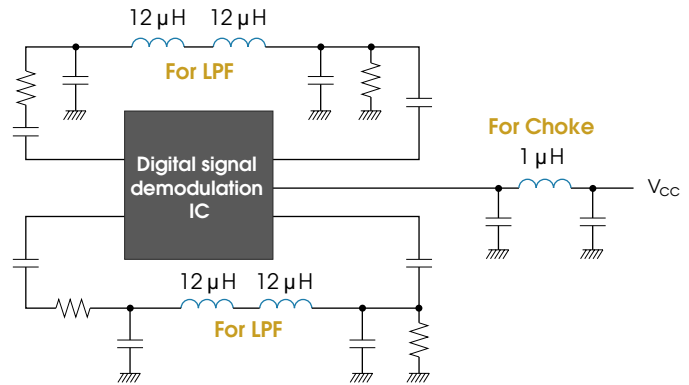

**ANALOGUE TV TUNER**

Analogue video signal input lines

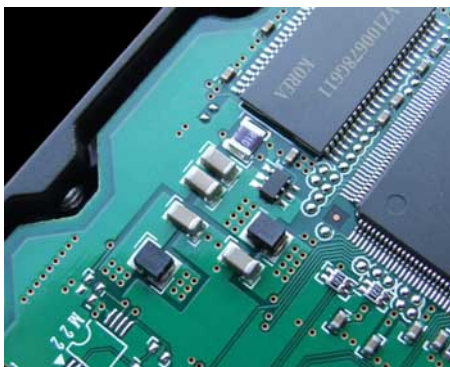
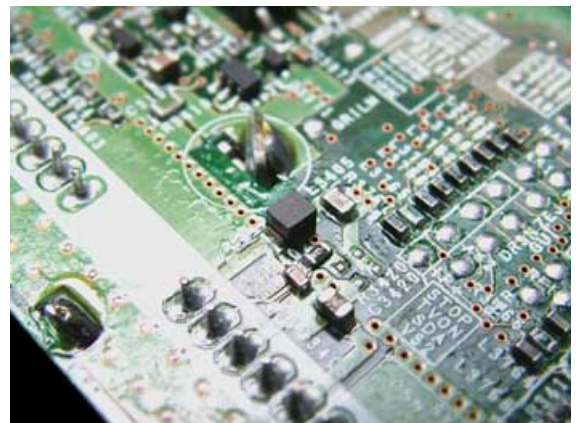
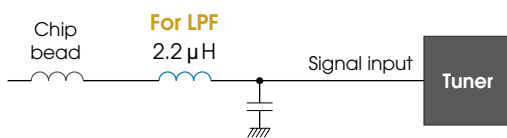

**ATA-COMPATIBLE HDD**

DC power lines of HDD controllers

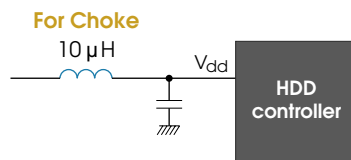

DC power lines of memories

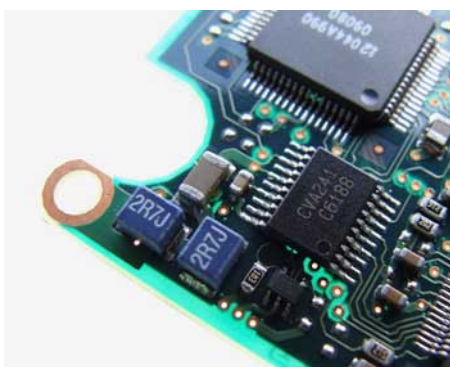
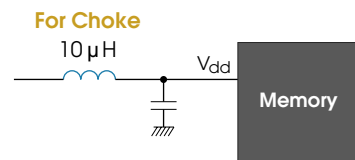

**BUILT-IN HDD OF LAPTOP PC**

Output lines of buffers/drivers ICs

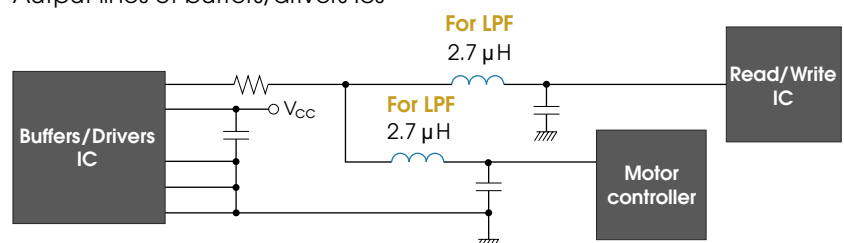

Application examples

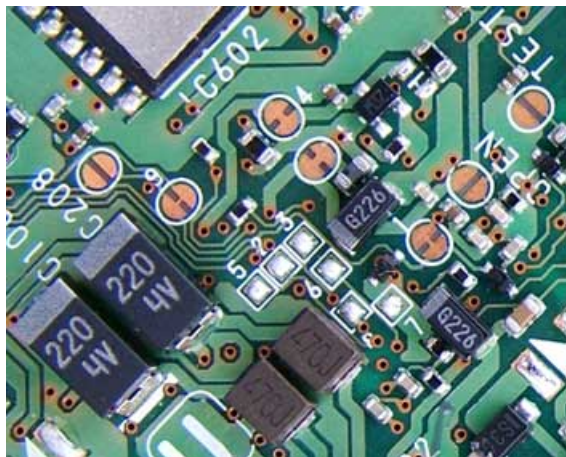

**PORTABLE CD PLAYER**

Audio output lines

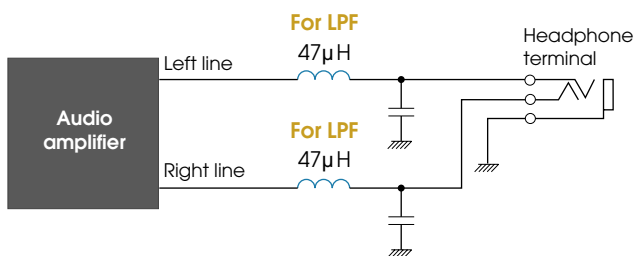

**PORTABLE DVD PLAYER**

Analogue video signal input lines

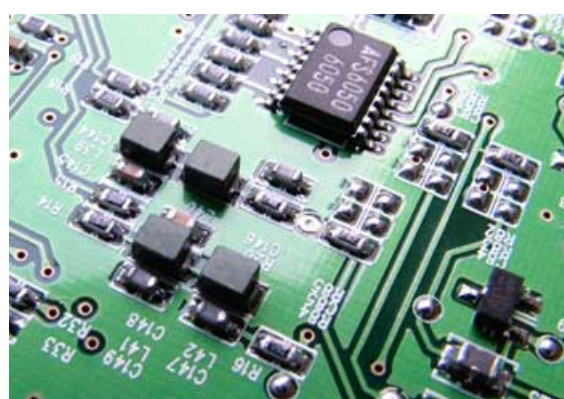
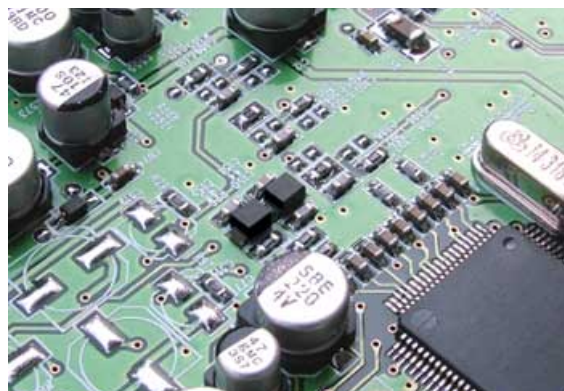
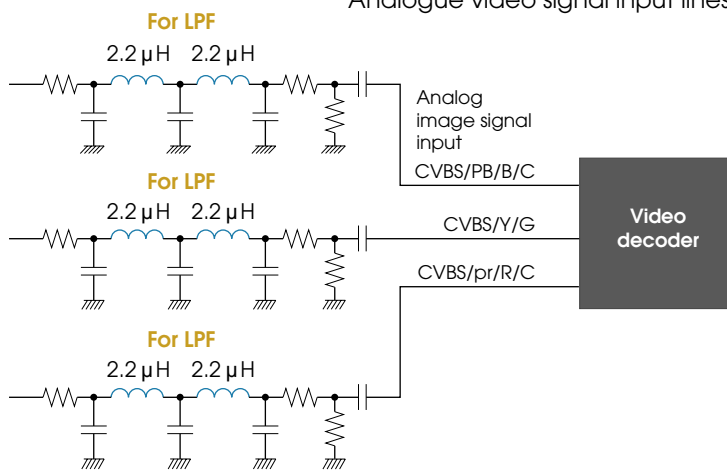

DC power lines

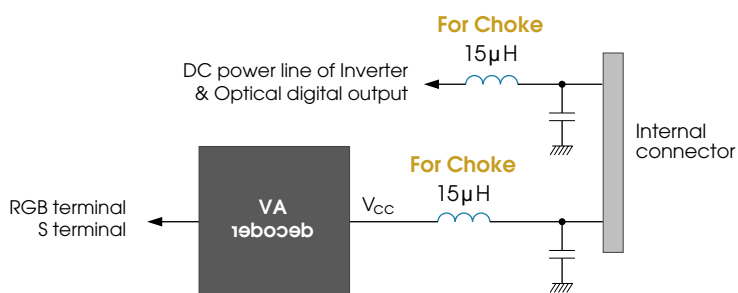



Wire-wound Surface Mount Small Inductors  
For Signal Lines And DC Power Lines  
NL/NLV, NLC/NLCV,  
NLFC/NLFV  
series

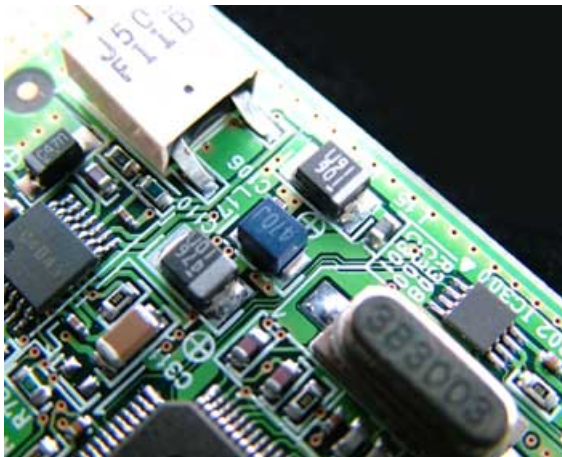
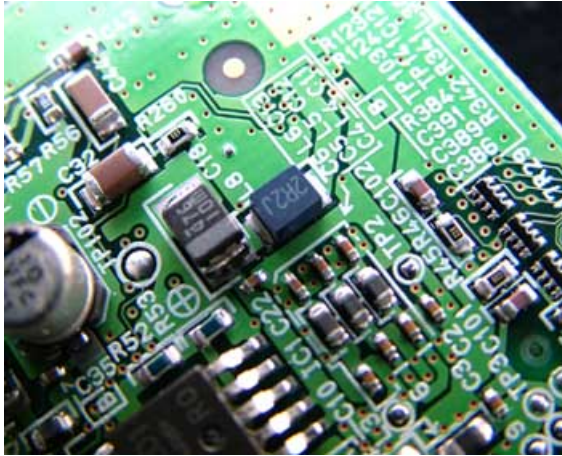
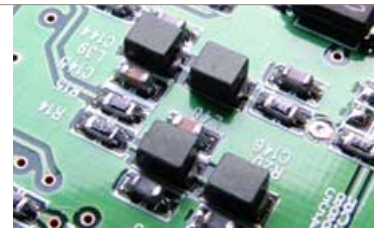

**MULTI DISPLAY FOR AUTOMOBILES**

Voltage control circuits

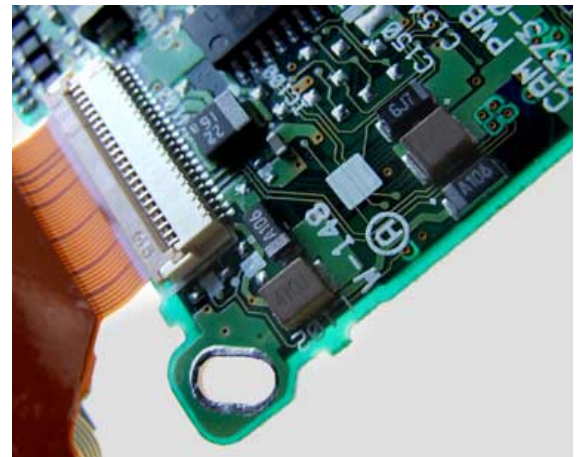
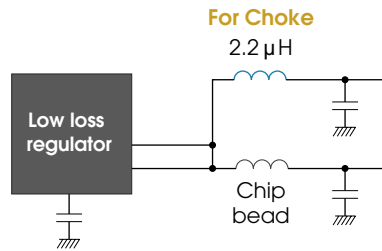

**DIGITAL STILL CAMERA**

DC power lines

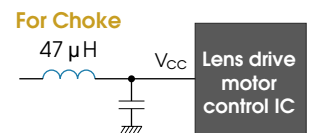
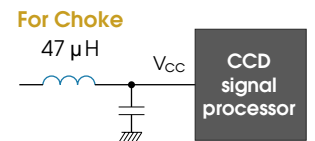

**ETC ON-BOARD UNIT**

Receiving circuit IF signal lines

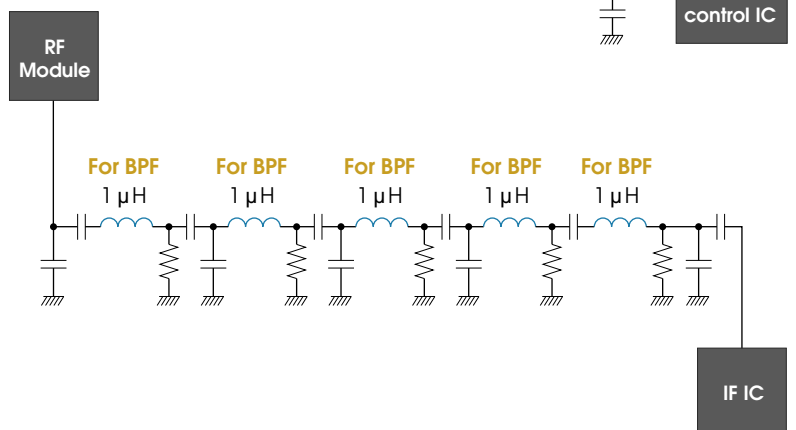
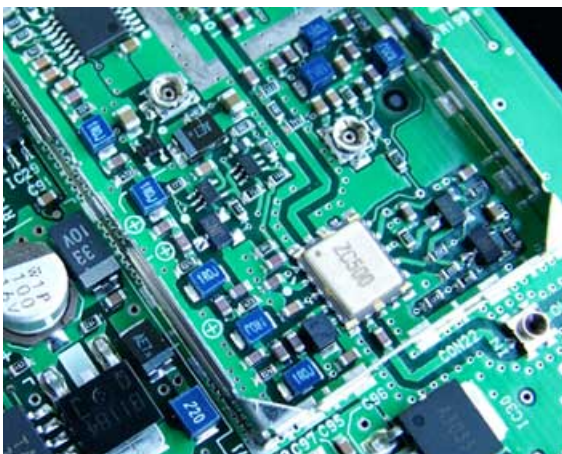



## Application examples

### CAR NAVIGATION SYSTEM

Power supply circuit  
 DC power line  
 GPS receiving circuit  
 Digital TV tuner  
 Video signal processing circuit  
 and so forth.

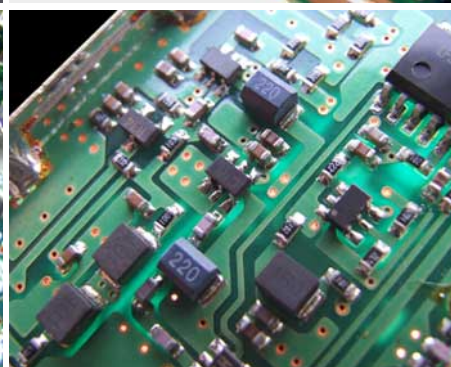
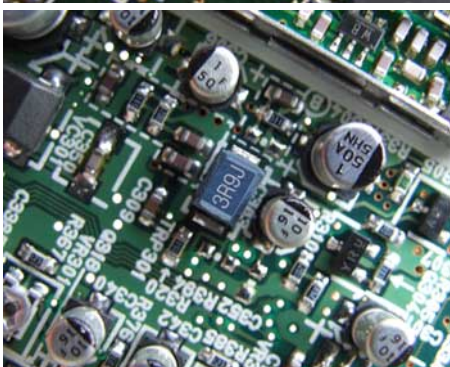
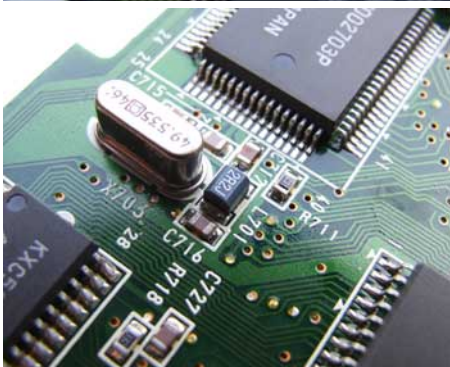
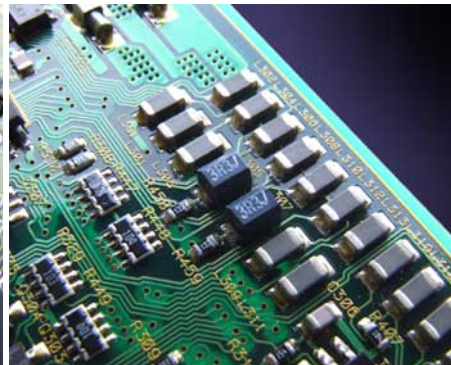
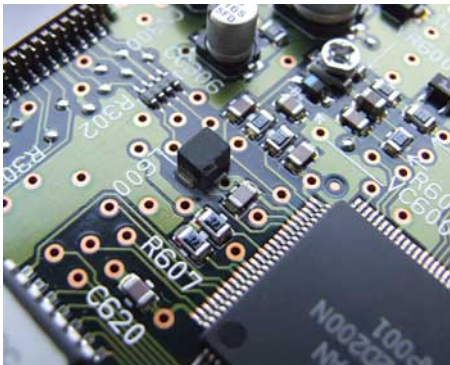
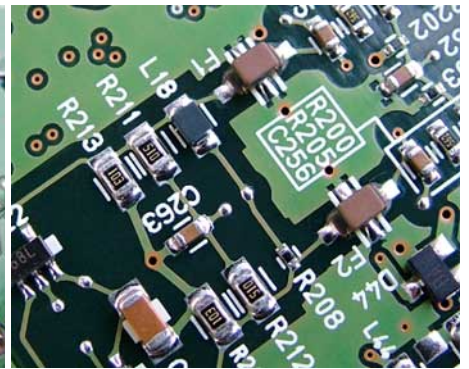
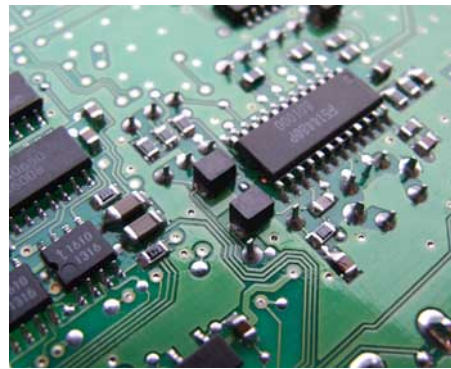
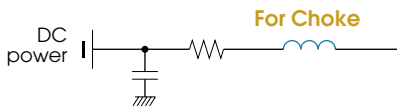
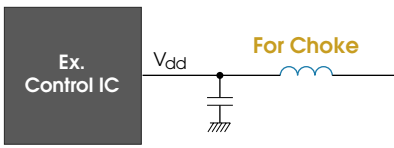
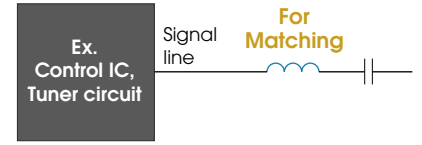
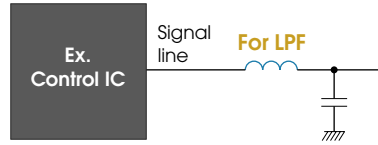

Wire-wound Surface Mount Small Inductors  
For Signal Lines And DC Power Lines

NL/NLV, NLC/NLCV,  
NLFC/NLJV  
series

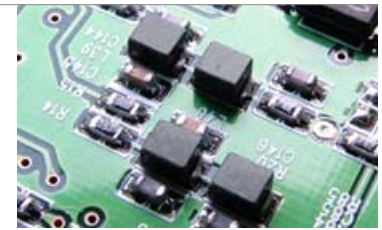

Product type data

Shapes and dimensions / Recommended PC board pattern

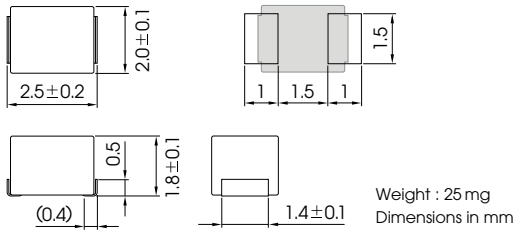

NLV25  
series

Wide  
L-value range  
High Q  
Narrow tolerances  
For signal lines  
NL / NLV



Large current  
choke  
For power lines  
NLC/NLCV



Low Rdc  
choke  
For power lines  
NLFC/NLJV



0.01 to 2.7 μH

Electrical characteristics

Inductance (μH)	Inductance tolerance (%)	Q min.	L, Q test frequency (MHz)	Self-resonance frequency (MHz) min.	DC resistance (Ω) max.	Rated current* (mA) max.	Part No.
0.01	±5	15	100	2150	0.26	530	NLV25T-010J-PF
0.012	±5	15	100	2050	0.27	500	NLV25T-012J-PF
0.015	±5	15	100	2000	0.29	480	NLV25T-015J-PF
0.018	±5	15	100	1850	0.31	450	NLV25T-018J-PF
0.022	±5	15	100	1650	0.37	420	NLV25T-022J-PF
0.027	±5	15	100	1550	0.4	410	NLV25T-027J-PF
0.033	±5	20	100	1450	0.42	400	NLV25T-033J-PF
0.039	±5	20	100	1350	0.45	380	NLV25T-039J-PF
0.047	±5	20	100	1200	0.5	360	NLV25T-047J-PF
0.056	±5	20	100	1100	0.6	340	NLV25T-056J-PF
0.068	±5	20	100	1050	0.65	320	NLV25T-068J-PF
0.082	±5	20	100	900	0.75	300	NLV25T-082J-PF
0.1	±5	20	100	800	0.8	280	NLV25T-R10J-PF
0.12	±5	30	25.2	700	0.3	550	NLV25T-R12J-PF
0.15	±5	30	25.2	550	0.35	500	NLV25T-R15J-PF
0.18	±5	30	25.2	500	0.4	460	NLV25T-R18J-PF
0.22	±5	30	25.2	450	0.5	430	NLV25T-R22J-PF
0.27	±5	30	25.2	425	0.55	420	NLV25T-R27J-PF
0.33	±5	30	25.2	400	0.6	400	NLV25T-R33J-PF
0.39	±5	30	25.2	375	0.65	375	NLV25T-R39J-PF
0.47	±5	30	25.2	350	0.68	350	NLV25T-R47J-PF
0.56	±5	30	25.2	325	0.75	325	NLV25T-R56J-PF
0.68	±5	30	25.2	300	0.85	300	NLV25T-R68J-PF
0.82	±5	30	25.2	260	1	260	NLV25T-R82J-PF
1	±5	30	7.96	245	1.1	245	NLV25T-1R0J-PF
1.2	±5	30	7.96	230	1.2	230	NLV25T-1R2J-PF
1.5	±5	30	7.96	182	1.3	220	NLV25T-1R5J-PF
1.8	±5	30	7.96	135	1.45	210	NLV25T-1R8J-PF
2.2	±5	30	7.96	105	1.55	200	NLV25T-2R2J-PF
2.7	±5	30	7.96	70	1.7	195	NLV25T-2R7J-PF

\* Rated current : The smaller value is applied between the values based on inductance change rate (decreased by 10% compared to the nominal inductance value) and the one based on temperature rise (20°C temperature rise by self-heating).

Measuring Instruments

L, Q (L 0.1 μH) : HP4191A Impedance/gain-phase analyzer (16092A) L, Q (L 0.12 μH) : HP4194A Impedance/gain-phase analyzer (16085A+16093B+TDK TF-1)

SRF : HP8753C Network analyzer Rdc : MATSUSHITA VP-2941A Digital milliohm meter



## Product type data

**NLV25**  
series
3.3 to 100 $\mu$ H**Electrical characteristics**

Inductance ( $\mu$ H)	Inductance tolerance (%)	Q min.	L, Q test frequency (MHz)	Self-resonance frequency (MHz) min.	DC resistance ( $\Omega$ ) max.	Rated current* (mA) max.	Part No.
3.3	$\pm 5$	30	7.96	55	1.9	185	NLV25T-3R3J-PF
3.9	$\pm 5$	30	7.96	48	2.1	180	NLV25T-3R9J-PF
4.7	$\pm 5$	30	7.96	43	2.3	175	NLV25T-4R7J-PF
5.6	$\pm 5$	25	7.96	42	2.5	170	NLV25T-5R6J-PF
6.8	$\pm 5$	25	7.96	39	2.7	165	NLV25T-6R8J-PF
8.2	$\pm 5$	25	7.96	36	3.05	160	NLV25T-8R2J-PF
10	$\pm 5$	25	2.52	33	3.5	155	NLV25T-100J-PF
12	$\pm 5$	25	2.52	30	3.8	150	NLV25T-120J-PF
15	$\pm 5$	25	2.52	26	4.4	140	NLV25T-150J-PF
18	$\pm 5$	25	2.52	24	4.8	130	NLV25T-180J-PF
22	$\pm 5$	25	2.52	22	5.5	125	NLV25T-220J-PF
27	$\pm 5$	25	2.52	21	6.3	115	NLV25T-270J-PF
33	$\pm 5$	25	2.52	20	7.1	110	NLV25T-330J-PF
39	$\pm 5$	20	2.52	18	9.5	90	NLV25T-390J-PF
47	$\pm 5$	20	2.52	17	11.1	80	NLV25T-470J-PF
56	$\pm 5$	20	2.52	16	12.1	75	NLV25T-560J-PF
68	$\pm 5$	20	2.52	15	16.6	70	NLV25T-680J-PF
82	$\pm 5$	20	2.52	13	19	66	NLV25T-820J-PF
100	$\pm 5$	15	0.796	12	21	60	NLV25T-101J-PF

\* Rated current : The smaller value is applied between the values based on inductance change rate (decreased by 10% compared to the nominal inductance value) and the one based on temperature rise (20°C temperature rise by self-heating).

Measuring Instruments

L, Q : HP4194A Impedance/gain-phase analyzer (16085A+16093B+TDK TF-1) SRF : HP8753C Network analyzer Rdc : MATSUSHITA VP-2941A Digital milliohm meter



Wire-wound Surface Mount Small Inductors  
For Signal Lines And DC Power Lines

NL/NLV, NLC/NLCV,  
NLFC/NLFV  
series

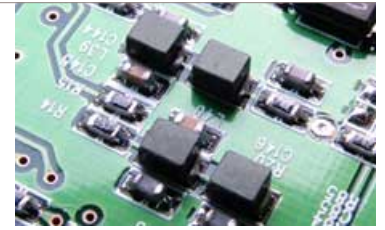

NLV25  
series

Inductance vs. frequency characteristics

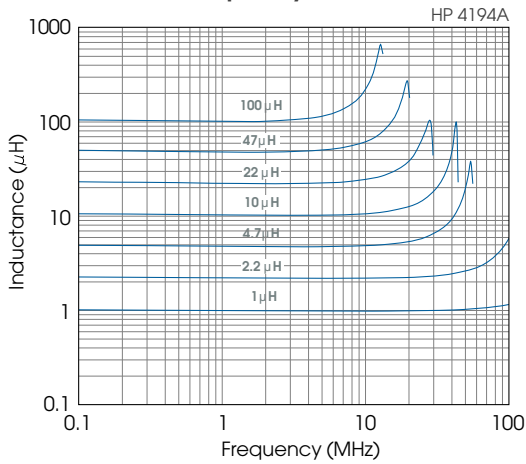

Impedance vs. frequency characteristics

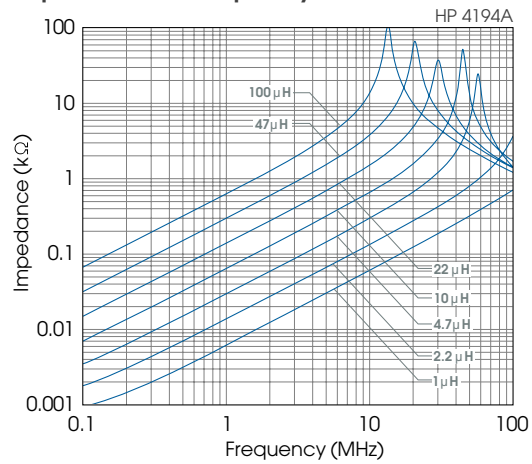

Inductance change vs.  
DC superposition characteristics

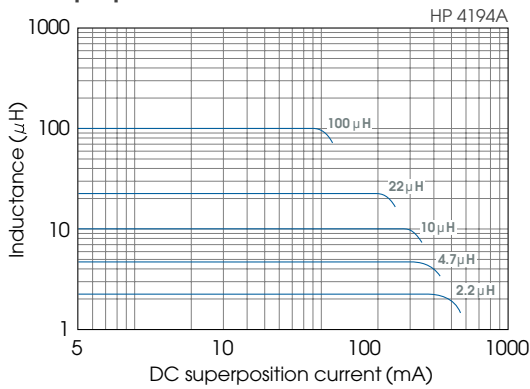

Q vs. frequency characteristics

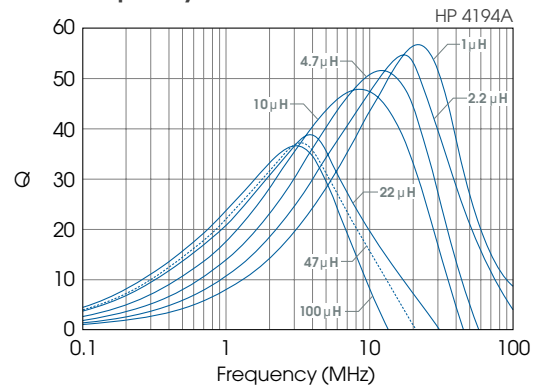

## Product type data

### Shapes and dimensions / Recommended PC board pattern

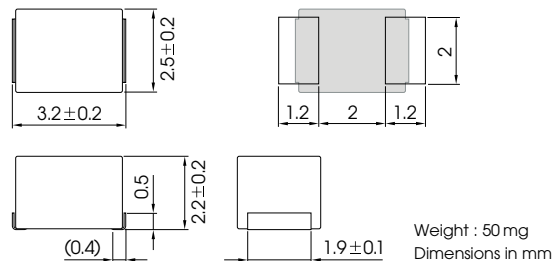

# NLV32

series

Wide L-value range  
High Q  
Narrow tolerances  
For signal lines  
**NL / NLV**

Large current choke  
For power lines  
**NLC / NLCV**

Low Rdc choke  
For power lines  
**NLFC / NLFV**



0.01 to 0.82  $\mu$ H

### Electrical characteristics

Inductance ( $\mu$ H)	Inductance tolerance (%)	Q min.	L, Q test frequency (MHz)	Self-resonance frequency (MHz) min.	DC resistance ( $\Omega$ ) max.	Rated current* (mA) max.	Part No.
0.01	$\pm 5$	15	100	2500	0.13	450	NLV32T-010J-PF
0.012	$\pm 5$	17	100	2300	0.14	450	NLV32T-012J-PF
0.015	$\pm 5$	19	100	2100	0.16	450	NLV32T-015J-PF
0.018	$\pm 5$	21	100	1900	0.18	450	NLV32T-018J-PF
0.022	$\pm 5$	23	100	1700	0.2	450	NLV32T-022J-PF
0.027	$\pm 5$	23	100	1500	0.22	450	NLV32T-027J-PF
0.033	$\pm 5$	25	100	1400	0.24	450	NLV32T-033J-PF
0.039	$\pm 5$	25	100	1300	0.27	450	NLV32T-039J-PF
0.047	$\pm 5$	26	100	1200	0.3	450	NLV32T-047J-PF
0.056	$\pm 5$	26	100	1100	0.33	450	NLV32T-056J-PF
0.068	$\pm 5$	27	100	1000	0.36	450	NLV32T-068J-PF
0.082	$\pm 5$	27	100	900	0.4	450	NLV32T-082J-PF
0.1	$\pm 5$	28	100	700	0.44	450	NLV32T-R10J-PF
0.12	$\pm 5$	30	25.2	500	0.22	450	NLV32T-R12J-PF
0.15	$\pm 5$	30	25.2	450	0.25	450	NLV32T-R15J-PF
0.18	$\pm 5$	30	25.2	400	0.28	450	NLV32T-R18J-PF
0.22	$\pm 5$	30	25.2	350	0.32	450	NLV32T-R22J-PF
0.27	$\pm 5$	30	25.2	320	0.36	450	NLV32T-R27J-PF
0.33	$\pm 5$	30	25.2	300	0.4	450	NLV32T-R33J-PF
0.39	$\pm 5$	30	25.2	250	0.45	450	NLV32T-R39J-PF
0.47	$\pm 5$	30	25.2	220	0.5	450	NLV32T-R47J-PF
0.56	$\pm 5$	30	25.2	180	0.55	450	NLV32T-R56J-PF
0.68	$\pm 5$	30	25.2	160	0.6	450	NLV32T-R68J-PF
0.82	$\pm 5$	30	25.2	140	0.65	450	NLV32T-R82J-PF

\* Rated current : The smaller value is applied between the values based on inductance change rate (decreased by 10% compared to the nominal inductance value) and the one based on temperature rise (20°C temperature rise by self-heating).

Measuring Instruments

L, Q (L 0.1  $\mu$ H) : HP4191A Impedance/gain-phase analyzer(16092A) L, Q (L 0.12  $\mu$ H) : HP4194A Impedance/gain-phase analyzer(16085A+16093B+TDK TF-1)  
SRF : HP8753C Network analyzer Rdc : MATSUSHITA VP-2941A Digital milliohm meter

Wire-wound Surface Mount Small Inductors  
For Signal Lines And DC Power Lines

NL/NLV, NLC/NLCV,  
NLFC/NLFV  
series

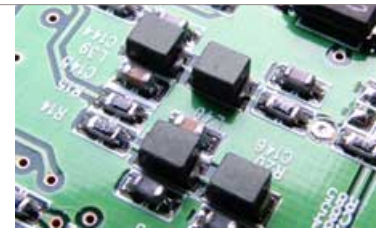

NLV32  
series

1 to 470 $\mu$ H

**Electrical characteristics**

Inductance ( $\mu$ H)	Inductance tolerance (%)	Q min.	L, Q test frequency (MHz)	Self-resonance frequency (MHz) min.	DC resistance ( $\Omega$ ) max.	Rated current* (mA) max.	Part No.
1	$\pm 5$	30	7.96	120	0.7	400	NLV32T-1R0J-PF
1.2	$\pm 5$	30	7.96	100	0.75	390	NLV32T-1R2J-PF
1.5	$\pm 5$	30	7.96	85	0.85	370	NLV32T-1R5J-PF
1.8	$\pm 5$	30	7.96	80	0.9	350	NLV32T-1R8J-PF
2.2	$\pm 5$	30	7.96	75	1	320	NLV32T-2R2J-PF
2.7	$\pm 5$	30	7.96	70	1.1	290	NLV32T-2R7J-PF
3.3	$\pm 5$	30	7.96	60	1.2	260	NLV32T-3R3J-PF
3.9	$\pm 5$	30	7.96	55	1.3	250	NLV32T-3R9J-PF
4.7	$\pm 5$	30	7.96	50	1.5	220	NLV32T-4R7J-PF
5.6	$\pm 5$	30	7.96	45	1.6	200	NLV32T-5R6J-PF
6.8	$\pm 5$	30	7.96	40	1.8	180	NLV32T-6R8J-PF
8.2	$\pm 5$	30	7.96	35	2	170	NLV32T-8R2J-PF
10	$\pm 5$	30	2.52	30	2.1	150	NLV32T-100J-PF
12	$\pm 5$	30	2.52	20	2.5	140	NLV32T-120J-PF
15	$\pm 5$	30	2.52	20	2.8	130	NLV32T-150J-PF
18	$\pm 5$	30	2.52	20	3.3	120	NLV32T-180J-PF
22	$\pm 5$	30	2.52	20	3.7	110	NLV32T-220J-PF
27	$\pm 5$	30	2.52	20	5	80	NLV32T-270J-PF
33	$\pm 5$	30	2.52	17	5.6	70	NLV32T-330J-PF
39	$\pm 5$	30	2.52	16	6.4	65	NLV32T-390J-PF
47	$\pm 5$	30	2.52	15	7	60	NLV32T-470J-PF
56	$\pm 5$	30	2.52	13	8	55	NLV32T-560J-PF
68	$\pm 5$	30	2.52	12	9	50	NLV32T-680J-PF
82	$\pm 5$	30	2.52	11	10	45	NLV32T-820J-PF
100	$\pm 5$	20	0.796	10	10	40	NLV32T-101J-PF
120	$\pm 5$	20	0.796	10	11	70	NLV32T-121J-PF
150	$\pm 5$	20	0.796	8	15	65	NLV32T-151J-PF
180	$\pm 5$	20	0.796	7	17	60	NLV32T-181J-PF
220	$\pm 5$	20	0.796	7	21	50	NLV32T-221J-PF
270	$\pm 5$	20	0.796	6	28	45	NLV32T-271J-PF
330	$\pm 5$	20	0.796	5	34	40	NLV32T-331J-PF
390	$\pm 5$	20	0.796	5	36	35	NLV32T-391J-PF
470	$\pm 5$	20	0.796	4	40	25	NLV32T-471J-PF

\* Rated current : The smaller value is applied between the values based on inductance change rate (decreased by 10% compared to the nominal inductance value) and the one based on temperature rise (20°C temperature rise by self-heating).

Measuring Instruments

L, Q: HP4194A Impedance/gain-phase analyzer(16085A+16093B+TDK TF-1) SRF: HP8753C Network analyzer Rdc: MATSUSHITA VP-2941A Digital milliohm meter



Product type data



Inductance vs. frequency characteristics

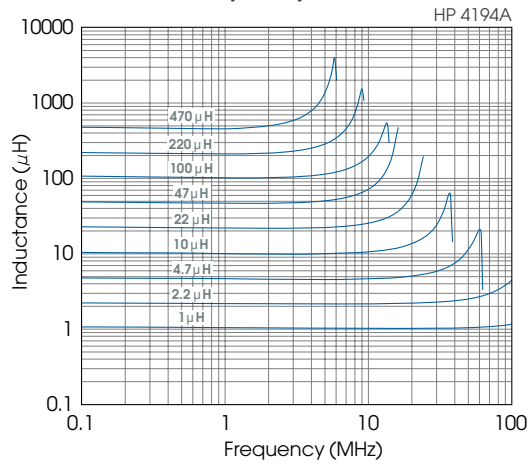

Impedance vs. frequency characteristics

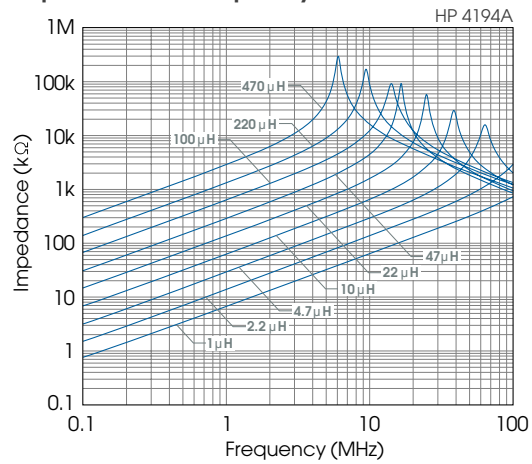

Inductance change vs. DC superposition characteristics

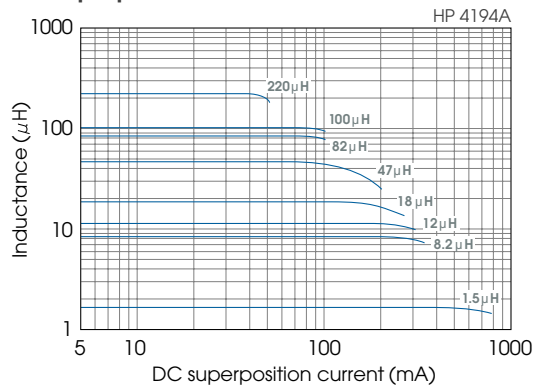

Q vs. frequency characteristics

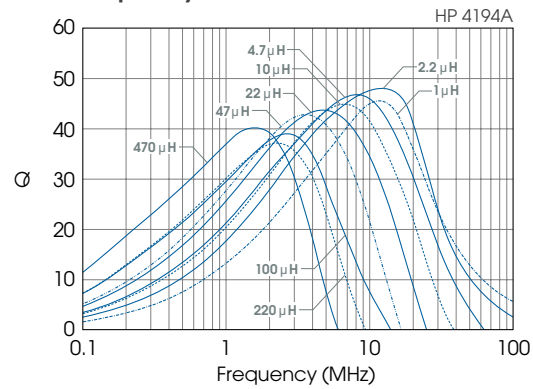

Wire-wound Surface Mount Small Inductors  
For Signal Lines And DC Power Lines

NL/NLV, NLC/NLCV,  
NLFC/NLFV  
series

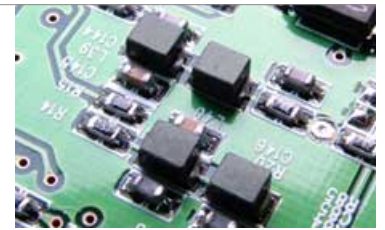

Shapes and dimensions / Recommended PC board pattern

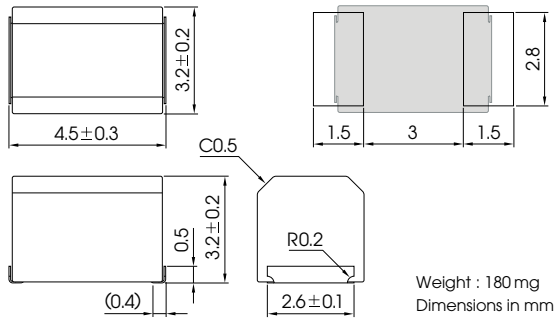

NL453232  
series



Wide  
L-value range  
High Q  
Narrow tolerances  
For signal lines  
**NL / NLV**



Large current  
choke  
For power lines  
**NLC / NLCV**



Low Rdc  
choke  
For power lines  
**NLFC / NLFV**



1 to 100  $\mu$ H

Electrical characteristics

Inductance ( $\mu$ H)	Inductance tolerance (%)	Q min.	L, Q test frequency (MHz)	Self-resonance frequency (MHz) min.	DC resistance ( $\Omega$ ) max.	Rated current* (mA) max.	Part No.
1	$\pm 5$	50	7.96	100	0.5	450	NL453232T-1R0J-PF
1.2	$\pm 5$	50	7.96	80	0.55	430	NL453232T-1R2J-PF
1.5	$\pm 5$	50	7.96	70	0.6	410	NL453232T-1R5J-PF
1.8	$\pm 5$	50	7.96	60	0.65	390	NL453232T-1R8J-PF
2.2	$\pm 5$	50	7.96	55	0.7	380	NL453232T-2R2J-PF
2.7	$\pm 5$	50	7.96	50	0.75	370	NL453232T-2R7J-PF
3.3	$\pm 5$	50	7.96	45	0.8	355	NL453232T-3R3J-PF
3.9	$\pm 5$	50	7.96	40	0.9	330	NL453232T-3R9J-PF
4.7	$\pm 5$	50	7.96	35	1	315	NL453232T-4R7J-PF
5.6	$\pm 5$	50	7.96	33	1.1	300	NL453232T-5R6J-PF
6.8	$\pm 5$	50	7.96	27	1.2	285	NL453232T-6R8J-PF
8.2	$\pm 5$	50	7.96	25	1.4	270	NL453232T-8R2J-PF
10	$\pm 5$	50	2.52	20	1.6	250	NL453232T-100J-PF
12	$\pm 5$	50	2.52	18	2	225	NL453232T-120J-PF
15	$\pm 5$	50	2.52	17	2.5	200	NL453232T-150J-PF
18	$\pm 5$	50	2.52	15	2.8	190	NL453232T-180J-PF
22	$\pm 5$	50	2.52	13	3.2	180	NL453232T-220J-PF
27	$\pm 5$	50	2.52	12	3.6	170	NL453232T-270J-PF
33	$\pm 5$	50	2.52	11	4	160	NL453232T-330J-PF
39	$\pm 5$	50	2.52	10	4.5	150	NL453232T-390J-PF
47	$\pm 5$	50	2.52	10	5	140	NL453232T-470J-PF
56	$\pm 5$	50	2.52	9	5.5	135	NL453232T-560J-PF
68	$\pm 5$	50	2.52	9	6	130	NL453232T-680J-PF
82	$\pm 5$	50	2.52	8	7	120	NL453232T-820J-PF
100	$\pm 5$	40	0.796	8	8	110	NL453232T-101J-PF

\* Rated current : The smaller value is applied between the values based on inductance change rate (decreased by 10% compared to the nominal inductance value) and the one based on temperature rise (20°C temperature rise by self-heating).

Measuring Instruments

L, Q : HP4194A Impedance/gain-phase analyzer(16085A+16093B+TDK TF-1)

SRF : HP8753C Network analyzer (Zin=Zout=50  $\Omega$ ) Rdc : MATSUSHITA VP-2941A Digital milliohm meter

## Product type data

# NL453232



## series

120 to 1000  $\mu$ H

### Electrical characteristics

Inductance ( $\mu$ H)	Inductance tolerance (%)	Q min.	L, Q test frequency (MHz)	Self-resonance frequency (MHz) min.	DC resistance ( $\Omega$ ) max.	Rated current* (mA) max.	Part No.
<b>120</b>	$\pm 5$	40	0.796	6	8	110	NL453232T-121J-PF
<b>150</b>	$\pm 5$	40	0.796	5	9	105	NL453232T-151J-PF
<b>180</b>	$\pm 5$	40	0.796	5	9.5	102	NL453232T-181J-PF
<b>220</b>	$\pm 5$	40	0.796	4	10	100	NL453232T-221J-PF
<b>270</b>	$\pm 5$	40	0.796	4	12	92	NL453232T-271J-PF
<b>330</b>	$\pm 5$	40	0.796	3.5	14	85	NL453232T-331J-PF
<b>390</b>	$\pm 5$	40	0.796	3	16	80	NL453232T-391J-PF
<b>470</b>	$\pm 5$	40	0.796	3	26	62	NL453232T-471J-PF
<b>560</b>	$\pm 5$	30	0.796	3	30	50	NL453232T-561J-PF
<b>680</b>	$\pm 5$	30	0.796	3	30	50	NL453232T-681J-PF
<b>820</b>	$\pm 5$	30	0.796	2.5	35	30	NL453232T-821J-PF
<b>1000</b>	$\pm 5$	30	0.252	2.5	40	30	NL453232T-102J-PF

\* Rated current : The smaller value is applied between the values based on inductance change rate (decreased by 10% compared to the nominal inductance value) and the one based on temperature rise (20°C temperature rise by self-heating).

Measuring Instruments

L, Q : HP4194A Impedance/gain-phase analyzer(16085A+16093B+TDK TF-1)

SRF : HP8753C Network analyzer (Zin=Zout=50  $\Omega$ ) Rdc : MATSUSHITA VP-2941A Digital milliohm meter



Wire-wound Surface Mount Small Inductors  
For Signal Lines And DC Power Lines

NL/NLV, NLC/NLCV,  
NLFC/NLFV  
series

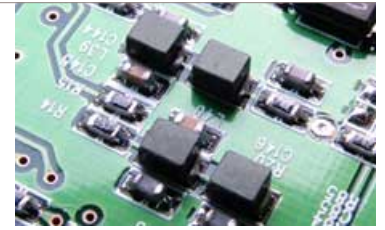

NL453232



series

Inductance vs. frequency characteristics

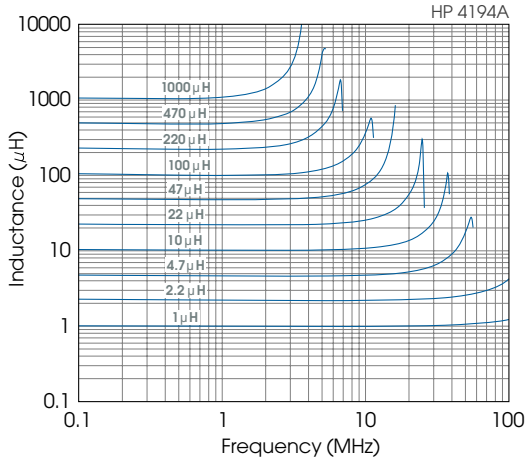

Impedance vs. frequency characteristics

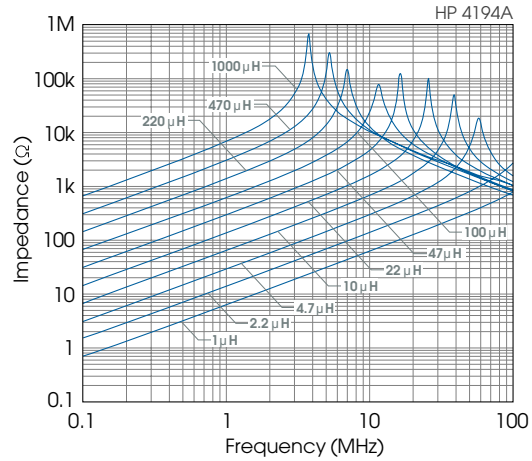

Inductance change vs.  
DC superposition characteristics

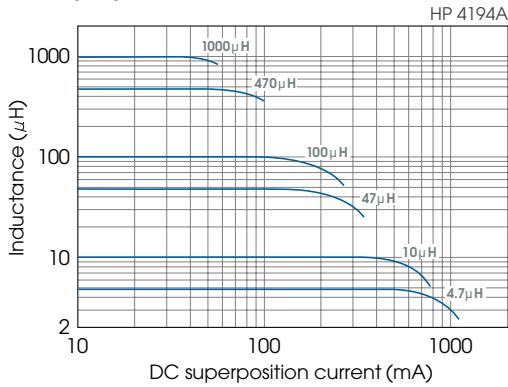

Q vs. frequency characteristics

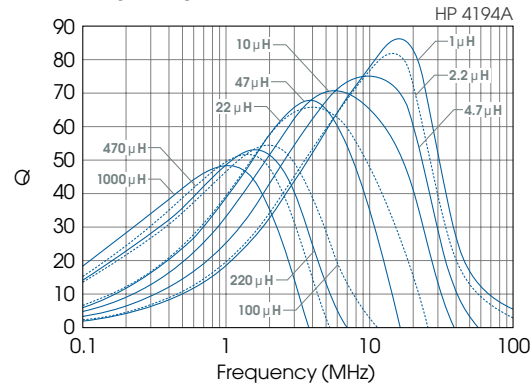

## Product type data

### Shapes and dimensions / Recommended PC board pattern

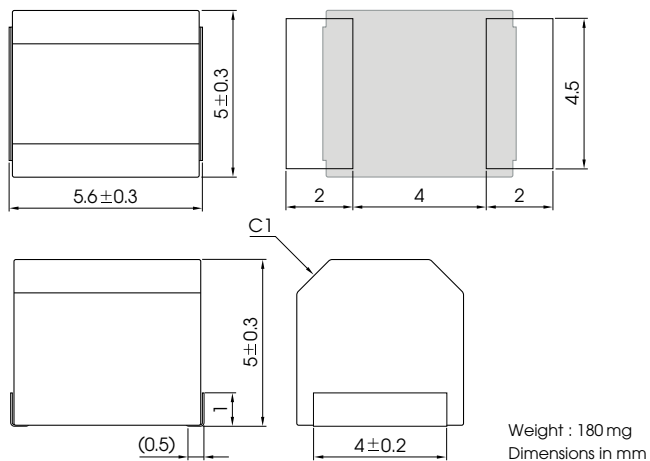

## NL565050 series



Wide L-value range  
High Q  
Narrow tolerances  
For signal lines  
**NL/NLV**



Large current choke  
For power lines  
**NLC/NLCV**



Low Rdc choke  
For power lines  
**NLFC/NLFV**



### Electrical characteristics

Inductance (μH)	Inductance tolerance (%)	Q min.	L, Q test frequency (MHz)	Self-resonance frequency (MHz) min.	DC resistance (Ω) max.	Rated current* (mA) max.	Part No.
1200	±5	30	0.252	1.5	17	75	<a href="#">NL565050T-122J-PF</a>
1500	±5	30	0.252	1.4	20	70	<a href="#">NL565050T-152J-PF</a>
1800	±5	30	0.252	1.3	30	60	<a href="#">NL565050T-182J-PF</a>
2200	±5	30	0.252	1.2	35	55	<a href="#">NL565050T-222J-PF</a>
2700	±5	30	0.252	1.1	55	45	<a href="#">NL565050T-272J-PF</a>
3300	±5	30	0.252	1	60	40	<a href="#">NL565050T-332J-PF</a>
3900	±5	30	0.252	1	70	38	<a href="#">NL565050T-392J-PF</a>
4700	±5	30	0.252	0.9	78	36	<a href="#">NL565050T-472J-PF</a>
5600	±5	30	0.252	0.8	85	33	<a href="#">NL565050T-562J-PF</a>
6800	±5	30	0.252	0.7	110	30	<a href="#">NL565050T-682J-PF</a>
8200	±5	30	0.252	0.6	125	28	<a href="#">NL565050T-822J-PF</a>
10000	±5	20	0.0796	0.5	150	25	<a href="#">NL565050T-103J-PF</a>

\* Rated current : The smaller value is applied between the values based on inductance change rate (decreased by 10% compared to the nominal inductance value) and the one based on temperature rise (20°C temperature rise by self-heating).

Measuring Instruments

L, Q : HP4194A Impedance/gain-phase analyzer(16085A+16093B+TDK TF-1)

SRF : HP8753C Network analyzer (Zin=Zout=50 Ω) Rdc : MATSUSHITA VP-2941A Digital milliohm meter

Wire-wound Surface Mount Small Inductors  
For Signal Lines And DC Power Lines

NL/NLV, NLC/NLCV,  
NLFC/NLFV  
series

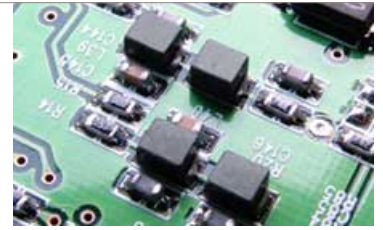

NL565050  
series

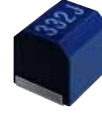

Inductance vs. frequency characteristics

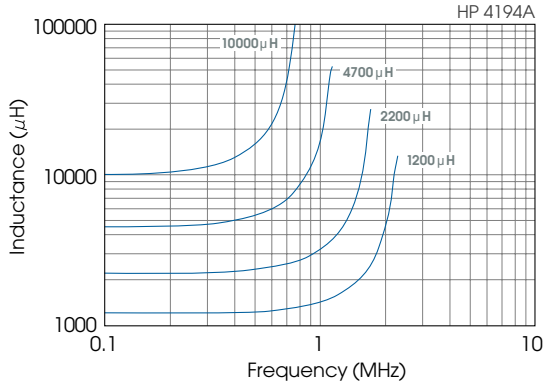

Impedance vs. frequency characteristics

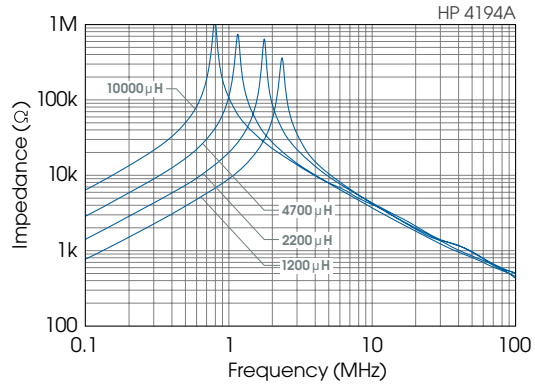

Inductance change vs.  
DC superposition characteristics

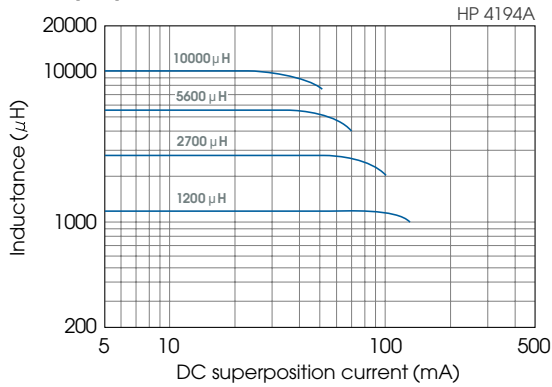

Q vs. frequency characteristics

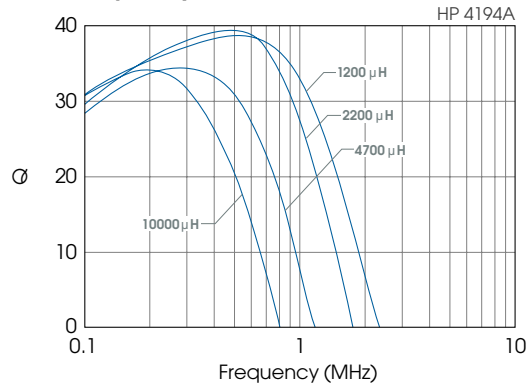



## Product type data

### Shapes and dimensions / Recommended PC board pattern

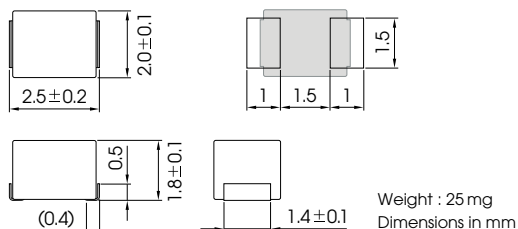

# NLCV25

series



### Electrical characteristics

Inductance ( $\mu\text{H}$ )	Inductance tolerance (%)	Q min.	L, Q test frequency (MHz)	Self-resonance frequency (MHz) min.	DC resistance ( $\Omega$ ) max.	Rated current* (mA) max.	Part No.
1	$\pm 20$	20	7.96	200	0.34	475	NLCV25T-1R0M-PF
1.5	$\pm 20$	20	7.96	165	0.42	435	NLCV25T-1R5M-PF
2.2	$\pm 20$	20	7.96	95	0.5	390	NLCV25T-2R2M-PF
3.3	$\pm 20$	20	7.96	55	0.65	340	NLCV25T-3R3M-PF
4.7	$\pm 20$	20	7.96	43	0.8	285	NLCV25T-4R7M-PF
6.8	$\pm 20$	20	7.96	39	1	275	NLCV25T-6R8M-PF
10	$\pm 10$	30	2.52	32	1.69	210	NLCV25T-100K-PF
15	$\pm 10$	30	2.52	21	2.2	175	NLCV25T-150K-PF
22	$\pm 10$	30	2.52	18	2.8	160	NLCV25T-220K-PF
33	$\pm 10$	30	2.52	16	4.2	120	NLCV25T-330K-PF

\* Rated current : The smaller value is applied between the values based on inductance change rate (decreased by 10% compared to the nominal inductance value) and the one based on temperature rise (20°C temperature rise by self-heating).

Measuring Instruments

L, Q : HP4194A Impedance/gain-phase analyzer(16085A+16093B+TDK TF-1) SRF : HP8753C Network analyzer Rdc : MATSUSHITA VP-2941A Digital milliohm meter

Wire-wound Surface Mount Small Inductors  
For Signal Lines And DC Power Lines

NL/NLV, NLC/NLCV,  
NLFC/NLFV  
series

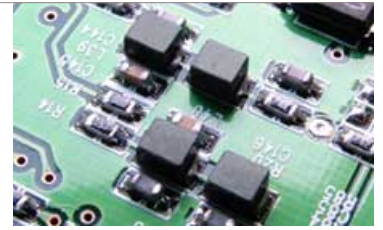

NLCV25  
series

Inductance vs. frequency characteristics

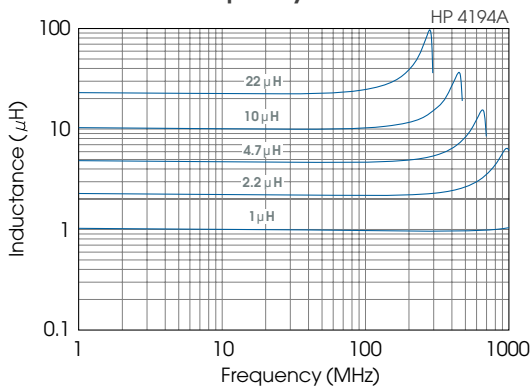

Impedance vs. frequency characteristics

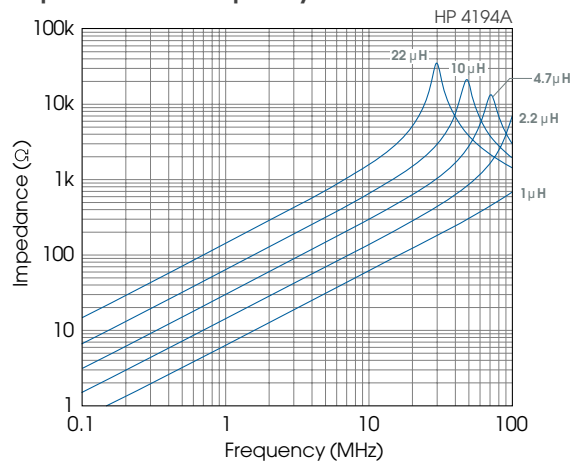

Inductance change vs.  
DC superposition characteristics

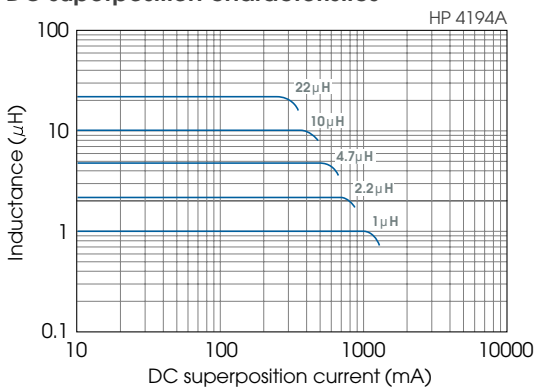

Q vs. frequency characteristics

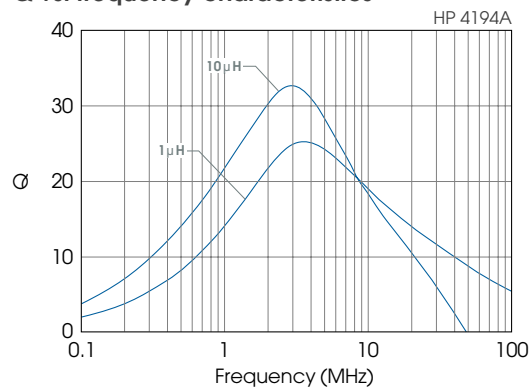

## Product type data

### Shapes and dimensions / Recommended PC board pattern

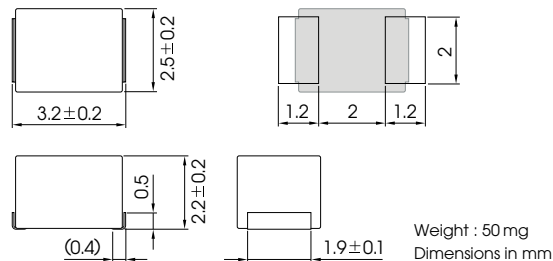

# NLCV32

series

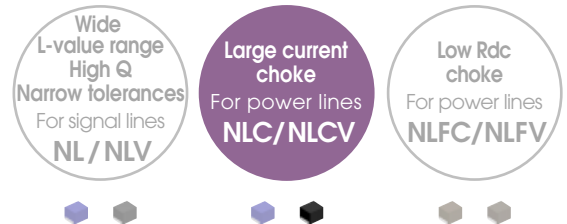

### Electrical characteristics

Inductance ( $\mu\text{H}$ )	Inductance tolerance (%)	Q min.	L, Q test frequency (MHz)	Self-resonance frequency (MHz) min.	DC resistance ( $\Omega$ ) max.	Rated current* (mA) max.	Part No.
0.15	$\pm 20$	5	25.2	400	0.028	1450	NLCV32T-R15M-PF
0.22	$\pm 20$	5	25.2	250	0.034	1250	NLCV32T-R22M-PF
0.47	$\pm 20$	5	25.2	150	0.042	1100	NLCV32T-R47M-PF
1	$\pm 20$	10	7.96	100	0.06	1000	NLCV32T-1R0M-PF
1.5	$\pm 20$	10	7.96	80	0.11	830	NLCV32T-1R5M-PF
2.2	$\pm 20$	10	7.96	68	0.13	770	NLCV32T-2R2M-PF
3.3	$\pm 20$	10	7.96	54	0.16	690	NLCV32T-3R3M-PF
4.7	$\pm 20$	15	7.96	46	0.2	620	NLCV32T-4R7M-PF
6.8	$\pm 20$	15	7.96	38	0.27	530	NLCV32T-6R8M-PF
10	$\pm 10$	15	2.52	30	0.36	450	NLCV32T-100K-PF
15	$\pm 10$	15	2.52	26	0.56	370	NLCV32T-150K-PF
22	$\pm 10$	15	2.52	21	0.77	300	NLCV32T-220K-PF
33	$\pm 10$	15	2.52	17	1.1	240	NLCV32T-330K-PF
47	$\pm 10$	15	2.52	14	1.64	180	NLCV32T-470K-PF
68	$\pm 10$	15	2.52	12	2.8	140	NLCV32T-680K-PF
100	$\pm 10$	15	0.796	10	3.7	120	NLCV32T-101K-PF
150	$\pm 10$	20	0.796	8	6.1	100	NLCV32T-151K-PF
220	$\pm 10$	20	0.796	7	8.4	80	NLCV32T-221K-PF
330	$\pm 10$	20	0.796	6	12.3	70	NLCV32T-331K-PF

\* Rated current : The smaller value is applied between the values based on inductance change rate (decreased by 10% compared to the nominal inductance value) and the one based on temperature rise (20°C temperature rise by self-heating).

Measuring Instruments

L, Q : YHP4194A Impedance analyzer+YHP16085A+YHP16093B+TF-1 SRF : HP8753C Network analyzer Rdc : MATSUSHITA VP-2941A Digital milliohm meter



Wire-wound Surface Mount Small Inductors  
For Signal Lines And DC Power Lines

NL/NLV, NLC/NLCV,  
NLFC/NLFV  
series

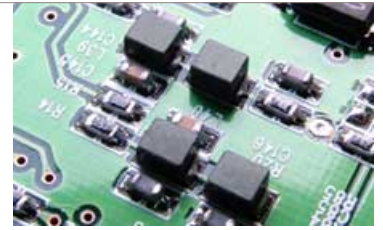

NLCV32  
series

Inductance vs. frequency characteristics

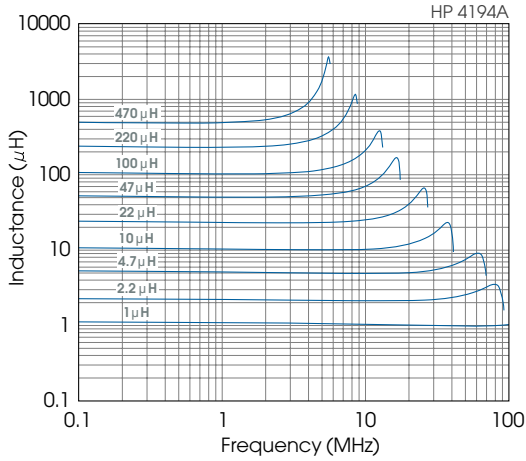

Impedance vs. frequency characteristics

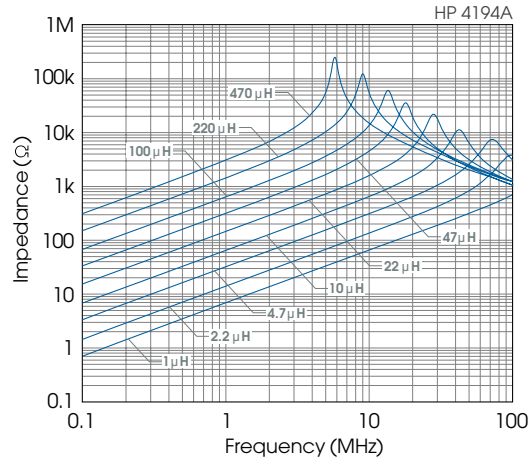

Inductance change vs.  
DC superposition characteristics

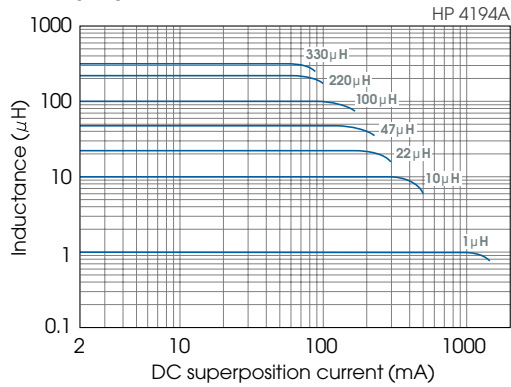

Q vs. frequency characteristics

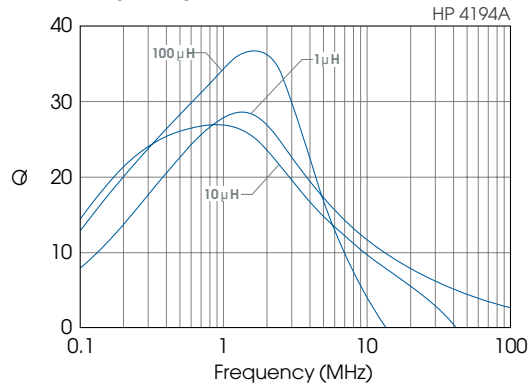

## Product type data

### Shapes and dimensions / Recommended PC board pattern

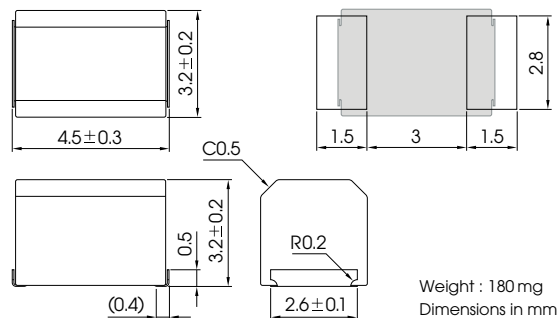

## NLC453232 series

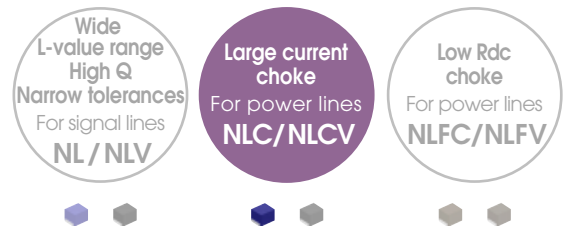

### Electrical characteristics

Inductance ( $\mu\text{H}$ )	Inductance tolerance (%)	Q min.	L, Q test frequency (MHz)	Self-resonance frequency (MHz) min.	DC resistance ( $\Omega$ ) max.	Rated current* (mA) max.	Part No.
1	$\pm 10$	10	7.96	200	0.11	1050	<a href="#">NLC453232T-1R0K-PF</a>
1.2	$\pm 10$	10	7.96	160	0.12	1000	<a href="#">NLC453232T-1R2K-PF</a>
1.5	$\pm 10$	10	7.96	130	0.15	950	<a href="#">NLC453232T-1R5K-PF</a>
1.8	$\pm 10$	10	7.96	100	0.16	900	<a href="#">NLC453232T-1R8K-PF</a>
2.2	$\pm 10$	10	7.96	80	0.18	850	<a href="#">NLC453232T-2R2K-PF</a>
2.7	$\pm 10$	10	7.96	60	0.2	800	<a href="#">NLC453232T-2R7K-PF</a>
3.3	$\pm 10$	10	7.96	45	0.22	750	<a href="#">NLC453232T-3R3K-PF</a>
3.9	$\pm 10$	10	7.96	40	0.24	700	<a href="#">NLC453232T-3R9K-PF</a>
4.7	$\pm 10$	10	7.96	35	0.27	650	<a href="#">NLC453232T-4R7K-PF</a>
5.6	$\pm 10$	10	7.96	30	0.3	650	<a href="#">NLC453232T-5R6K-PF</a>
6.8	$\pm 10$	10	7.96	28	0.35	600	<a href="#">NLC453232T-6R8K-PF</a>
8.2	$\pm 10$	10	7.96	25	0.4	600	<a href="#">NLC453232T-8R2K-PF</a>
10	$\pm 10$	10	2.52	22	0.5	550	<a href="#">NLC453232T-100K-PF</a>
12	$\pm 10$	10	2.52	21	0.6	500	<a href="#">NLC453232T-120K-PF</a>
15	$\pm 10$	10	2.52	20	0.7	450	<a href="#">NLC453232T-150K-PF</a>
18	$\pm 10$	10	2.52	19	0.8	400	<a href="#">NLC453232T-180K-PF</a>
22	$\pm 10$	10	2.52	18	0.9	370	<a href="#">NLC453232T-220K-PF</a>
27	$\pm 10$	10	2.52	16	1.2	330	<a href="#">NLC453232T-270K-PF</a>
33	$\pm 10$	10	2.52	14	1.4	300	<a href="#">NLC453232T-330K-PF</a>
39	$\pm 10$	10	2.52	12	1.6	280	<a href="#">NLC453232T-390K-PF</a>
47	$\pm 10$	10	2.52	11.5	1.9	260	<a href="#">NLC453232T-470K-PF</a>
56	$\pm 10$	10	2.52	11	2.2	240	<a href="#">NLC453232T-560K-PF</a>
68	$\pm 10$	10	2.52	10	2.6	220	<a href="#">NLC453232T-680K-PF</a>
82	$\pm 10$	10	2.52	9	3.5	200	<a href="#">NLC453232T-820K-PF</a>
100	$\pm 10$	20	0.796	8	4	180	<a href="#">NLC453232T-101K-PF</a>
120	$\pm 10$	20	0.796	7.5	4.5	160	<a href="#">NLC453232T-121K-PF</a>
150	$\pm 10$	20	0.796	7	6.5	140	<a href="#">NLC453232T-151K-PF</a>
180	$\pm 10$	20	0.796	6.5	7.5	120	<a href="#">NLC453232T-181K-PF</a>
220	$\pm 10$	20	0.796	5.5	9	120	<a href="#">NLC453232T-221K-PF</a>
270	$\pm 10$	20	0.796	5	11	100	<a href="#">NLC453232T-271K-PF</a>
330	$\pm 10$	20	0.796	4	13	90	<a href="#">NLC453232T-331K-PF</a>

\* Rated current : The smaller value is applied between the values based on inductance change rate (decreased by 10% compared to the nominal inductance value) and the one based on temperature rise (20°C temperature rise by self-heating).

Measuring Instruments L, Q : HP4194A Impedance/gain-phase analyzer(16085A+16093B+TDK TF-1) SRF : HP8753C Network analyzer( $Z_{in}=Z_{out}=50 \Omega$ )  
Rdc : MATSUSHITA VP-2941A Digital milliohm meter

Wire-wound Surface Mount Small Inductors  
For Signal Lines And DC Power Lines

NL/NLV, NLC/NLCV,  
NLFC/NLHV  
series

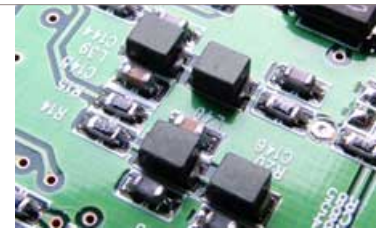

NLC453232  
series



Inductance vs. frequency characteristics

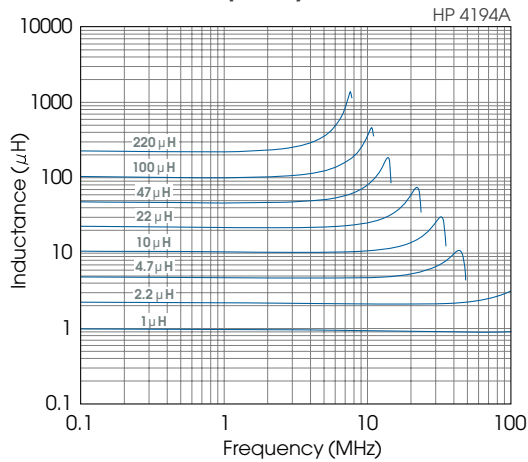

Impedance vs. frequency characteristics

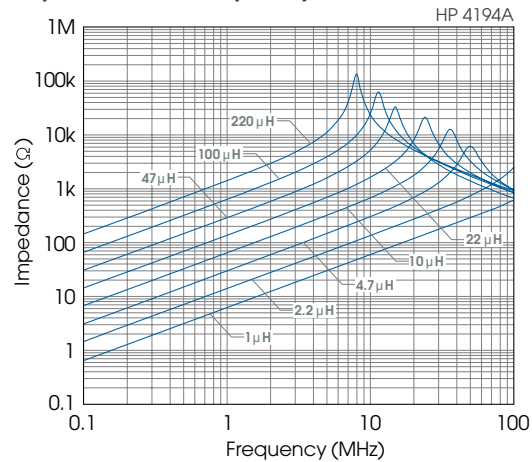

Inductance change vs.  
DC superposition characteristics

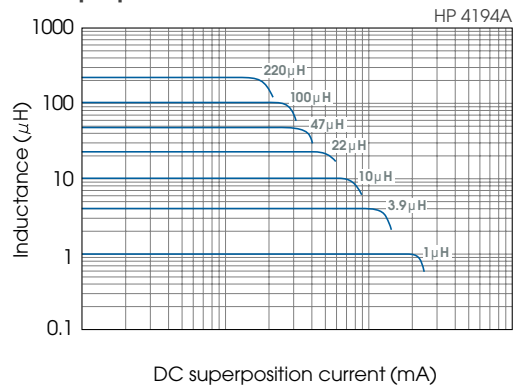

Q vs. frequency characteristics

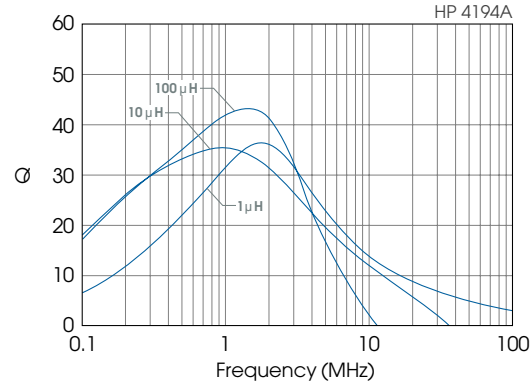



## Product type data

### Shapes and dimensions / Recommended PC board pattern

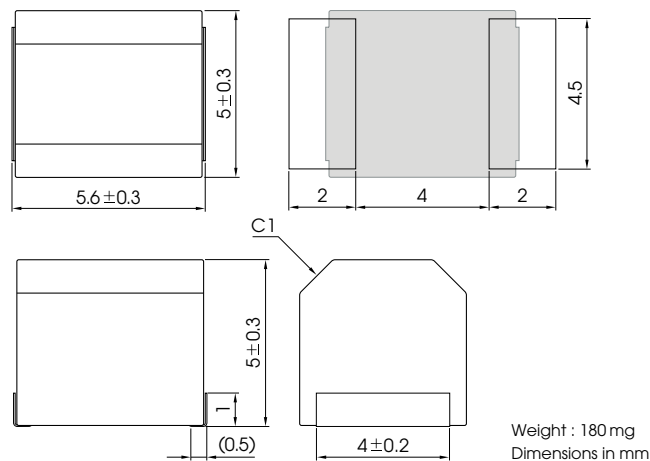

## NLC565050 series

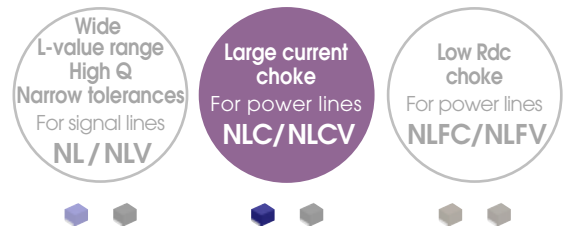

1 to 220  $\mu$ H

### Electrical characteristics

Inductance ( $\mu$ H)	Inductance tolerance (%)	Q min.	L, Q test frequency (MHz)	Self-resonance frequency (MHz) min.	DC resistance ( $\Omega$ ) max.	Rated current* (mA) max.	Part No.
1	$\pm 10$	10	7.96	95	0.03	1800	<a href="#">NLC565050T-1R0K-PF</a>
1.2	$\pm 10$	10	7.96	70	0.035	1700	<a href="#">NLC565050T-1R2K-PF</a>
1.5	$\pm 10$	10	7.96	55	0.04	1600	<a href="#">NLC565050T-1R5K-PF</a>
1.8	$\pm 10$	10	7.96	47	0.05	1400	<a href="#">NLC565050T-1R8K-PF</a>
2.2	$\pm 10$	10	7.96	42	0.06	1300	<a href="#">NLC565050T-2R2K-PF</a>
2.7	$\pm 10$	10	7.96	37	0.07	1200	<a href="#">NLC565050T-2R7K-PF</a>
3.3	$\pm 10$	10	7.96	34	0.08	1120	<a href="#">NLC565050T-3R3K-PF</a>
3.9	$\pm 10$	10	7.96	32	0.09	1050	<a href="#">NLC565050T-3R9K-PF</a>
4.7	$\pm 10$	10	7.96	29	0.11	950	<a href="#">NLC565050T-4R7K-PF</a>
5.6	$\pm 10$	10	7.96	26	0.13	880	<a href="#">NLC565050T-5R6K-PF</a>
6.8	$\pm 10$	10	7.96	24	0.15	810	<a href="#">NLC565050T-6R8K-PF</a>
8.2	$\pm 10$	10	7.96	22	0.18	750	<a href="#">NLC565050T-8R2K-PF</a>
10	$\pm 10$	10	2.52	19	0.21	690	<a href="#">NLC565050T-100K-PF</a>
12	$\pm 10$	10	2.52	17	0.25	630	<a href="#">NLC565050T-120K-PF</a>
15	$\pm 10$	10	2.52	16	0.3	580	<a href="#">NLC565050T-150K-PF</a>
18	$\pm 10$	10	2.52	14	0.36	530	<a href="#">NLC565050T-180K-PF</a>
22	$\pm 10$	10	2.52	13	0.43	480	<a href="#">NLC565050T-220K-PF</a>
27	$\pm 10$	10	2.52	11.5	0.52	440	<a href="#">NLC565050T-270K-PF</a>
33	$\pm 10$	10	2.52	10.5	0.62	400	<a href="#">NLC565050T-330K-PF</a>
39	$\pm 10$	10	2.52	9.5	0.72	370	<a href="#">NLC565050T-390K-PF</a>
47	$\pm 10$	10	2.52	8.5	0.85	340	<a href="#">NLC565050T-470K-PF</a>
56	$\pm 10$	10	2.52	7.8	1	310	<a href="#">NLC565050T-560K-PF</a>
68	$\pm 10$	10	2.52	7	1.2	290	<a href="#">NLC565050T-680K-PF</a>
82	$\pm 10$	10	2.52	6.4	1.4	270	<a href="#">NLC565050T-820K-PF</a>
100	$\pm 10$	20	0.796	6	1.6	250	<a href="#">NLC565050T-101K-PF</a>
120	$\pm 10$	20	0.796	5.4	1.9	230	<a href="#">NLC565050T-121K-PF</a>
150	$\pm 10$	20	0.796	4.8	2.2	210	<a href="#">NLC565050T-151K-PF</a>
180	$\pm 10$	20	0.796	4.4	2.8	190	<a href="#">NLC565050T-181K-PF</a>
220	$\pm 10$	20	0.796	3.9	3.4	170	<a href="#">NLC565050T-221K-PF</a>

\* Rated current : The smaller value is applied between the values based on inductance change rate (decreased by 10% compared to the nominal inductance value) and the one based on temperature rise (20°C temperature rise by self-heating).

Measuring Instruments L, Q : HP4194A Impedance/gain-phase analyzer(16085A+16093B+TDK TF-1) SRF : HP8753C Network analyzer( $Z_{in}=Z_{out}=50 \Omega$ )  
 Rdc : MATSUSHITA VP-2941A Digital milliohm meter

Wire-wound Surface Mount Small Inductors  
For Signal Lines And DC Power Lines

NL/NLV, NLC/NLCV,  
NLFC/NLTV  
series

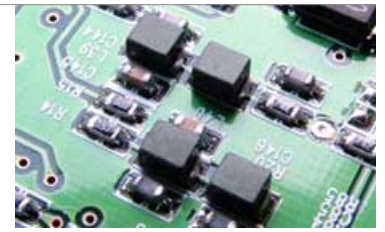

NLC565050  
series

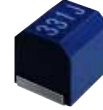

270 to 1000  $\mu\text{H}$

**Electrical characteristics**

Inductance ( $\mu\text{H}$ )	Inductance tolerance (%)	Q min.	L, Q test frequency (MHz)	Self-resonance frequency (MHz) min.	DC resistance ( $\Omega$ ) max.	Rated current* (mA) max.	Part No.
270	$\pm 10$	20	0.796	3.6	4.2	155	NLC565050T-271K-PF
330	$\pm 10$	20	0.796	3.2	4.9	140	NLC565050T-331K-PF
390	$\pm 10$	20	0.796	2.9	5.8	130	NLC565050T-391K-PF
470	$\pm 10$	20	0.796	2.6	7	120	NLC565050T-471K-PF
560	$\pm 10$	20	0.796	2.4	8.5	110	NLC565050T-561K-PF
680	$\pm 10$	20	0.796	2.2	10	100	NLC565050T-681K-PF
820	$\pm 10$	20	0.796	2	13	90	NLC565050T-821K-PF
1000	$\pm 10$	20	0.252	1.8	15	85	NLC565050T-102K-PF

\* Rated current : The smaller value is applied between the values based on inductance change rate (decreased by 10% compared to the nominal inductance value) and the one based on temperature rise (20°C temperature rise by self-heating).

Measuring Instruments

L, Q : HP4194A Impedance/gain-phase analyzer(16085A+16093B+TDK TF-1) SRF : HP8753C Network analyzer ( $Z_{in}=Z_{out}=50 \Omega$ )

Rdc : MATSUSHITA VP-2941A Digital milliohm meter

**Inductance vs. frequency characteristics**

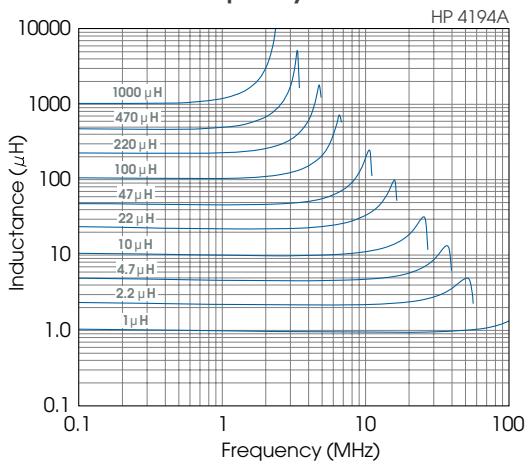

**Impedance vs. frequency characteristics**

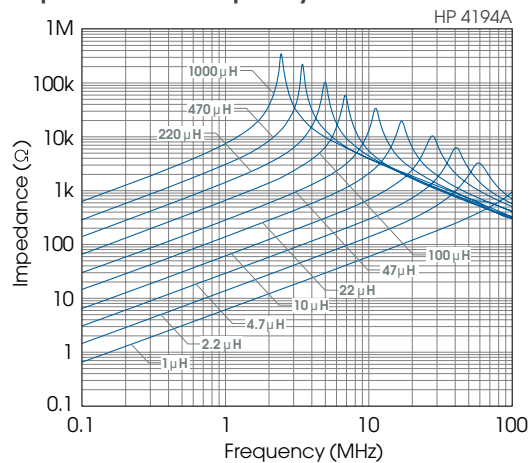

**Inductance change vs. DC superposition characteristics**

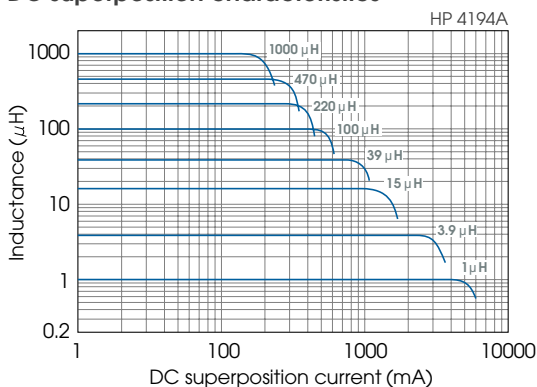

**Q vs. frequency characteristics**

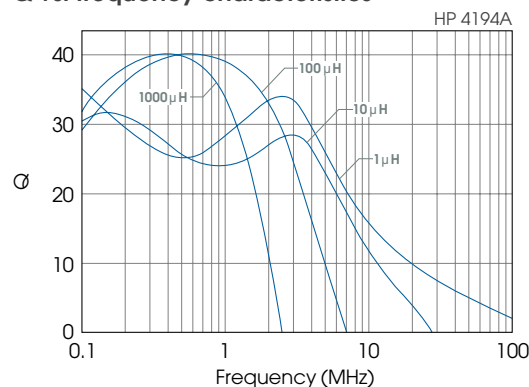

## Product type data

### Shapes and dimensions / Recommended PC board pattern

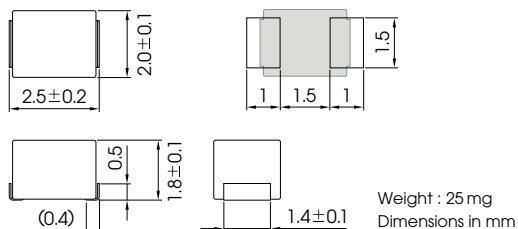

# NLFV25

series



### Electrical characteristics

Inductance ( $\mu\text{H}$ )	Inductance tolerance (%)	Q min.	L, Q test frequency (MHz)	Self-resonance frequency (MHz) min.	DC resistance ( $\Omega$ ) max.	Rated current* (mA) max.	Part No.
1	$\pm 20$	5	7.96	100	0.07	455	NLFV25T-1R0M-PF
1.5	$\pm 20$	5	7.96	80	0.09	350	NLFV25T-1R5M-PF
2.2	$\pm 20$	5	7.96	70	0.1	315	NLFV25T-2R2M-PF
3.3	$\pm 20$	5	7.96	55	0.2	280	NLFV25T-3R3M-PF
4.7	$\pm 20$	5	7.96	45	0.24	210	NLFV25T-4R7M-PF
6.8	$\pm 20$	5	7.96	38	0.29	175	NLFV25T-6R8M-PF
10	$\pm 10$	10	2.52	32	0.36	155	NLFV25T-100K-PF
15	$\pm 10$	10	2.52	28	0.75	130	NLFV25T-150K-PF
22	$\pm 10$	10	2.52	16	1	105	NLFV25T-220K-PF
33	$\pm 10$	10	2.52	14	1.4	85	NLFV25T-330K-PF
47	$\pm 10$	10	2.52	11	1.7	60	NLFV25T-470K-PF
68	$\pm 10$	10	2.52	10	3.3	50	NLFV25T-680K-PF
100	$\pm 10$	10	0.796	8	4	40	NLFV25T-101K-PF

\* Rated current : The smaller value is applied between the values based on inductance change rate (decreased by 10% compared to the nominal inductance value) and the one based on temperature rise (20°C temperature rise by self-heating).

Measuring Instruments

L, Q : HP4194A Impedance/gain-phase analyzer(16085A+16093B+TDK TF-1) SRF : HP8753C Network analyzer Rdc : MATSUSHITA VP-2941A Digital milliohm meter

Wire-wound Surface Mount Small Inductors  
For Signal Lines And DC Power Lines

NL/NLV, NLC/NLCV,  
NLFC/NLFV  
series

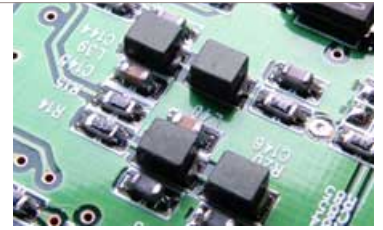

NLFV25  
series

Inductance vs. frequency characteristics

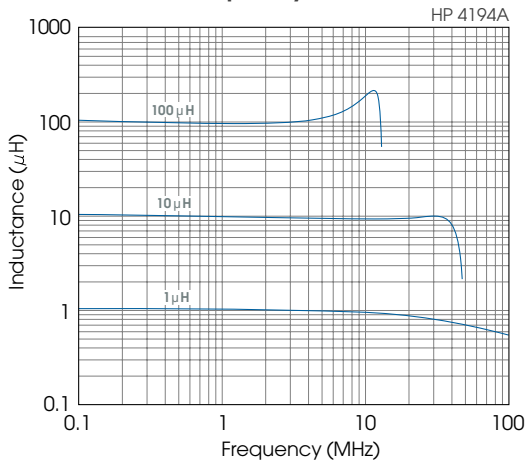

Impedance vs. frequency characteristics

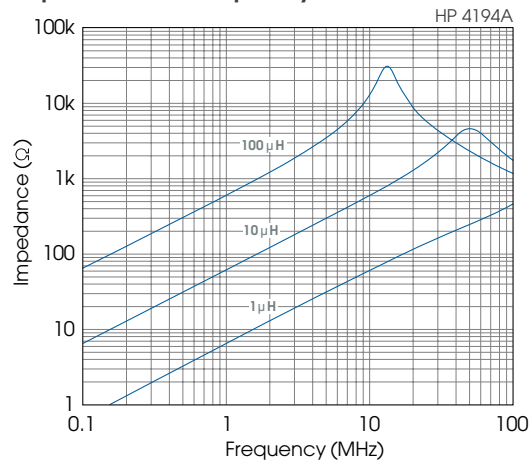

Inductance change vs.  
DC superposition characteristics

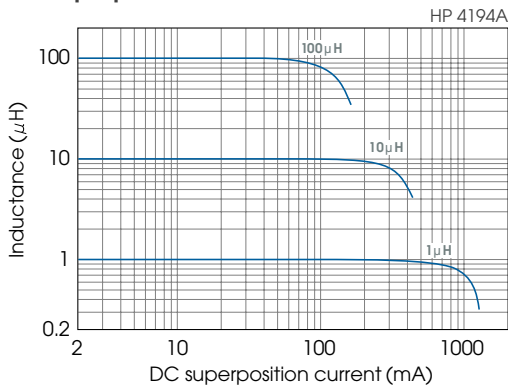

Q vs. frequency characteristics

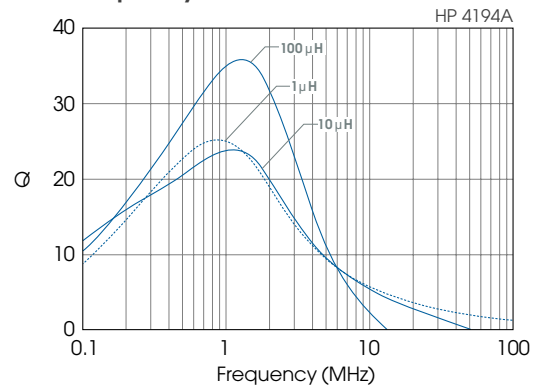



## Product type data

### Shapes and dimensions / Recommended PC board pattern

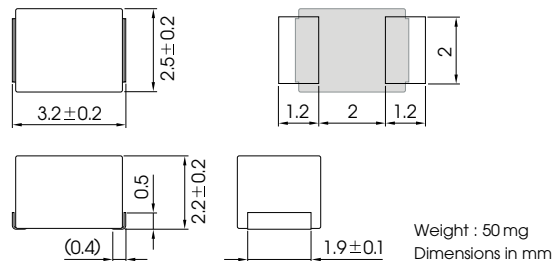

# NLFC322522

series

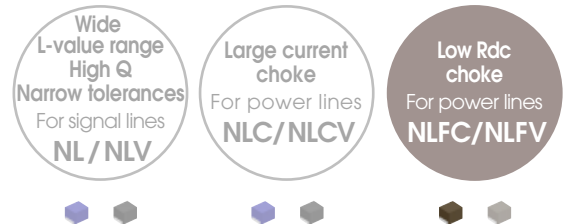

### Electrical characteristics

Inductance ( $\mu\text{H}$ )	Inductance tolerance (%)	Q min.	L, Q test frequency (MHz)	Self-resonance frequency (MHz) min.	DC resistance ( $\Omega$ ) max.	Rated current* (mA) max.	Part No.
1	$\pm 20$	5	7.96	100	0.06	500	NLFC322522T-1R0M-PF
1.5	$\pm 20$	5	7.96	80	0.08	400	NLFC322522T-1R5M-PF
2.2	$\pm 20$	5	7.96	68	0.09	340	NLFC322522T-2R2M-PF
3.3	$\pm 20$	5	7.96	54	0.11	270	NLFC322522T-3R3M-PF
4.7	$\pm 20$	5	7.96	46	0.13	240	NLFC322522T-4R7M-PF
6.8	$\pm 20$	5	7.96	38	0.17	195	NLFC322522T-6R8M-PF
10	$\pm 10$	10	2.52	30	0.26	165	NLFC322522T-100K-PF
15	$\pm 10$	10	2.52	26	0.32	145	NLFC322522T-150K-PF
22	$\pm 10$	10	2.52	21	0.5	115	NLFC322522T-220K-PF
33	$\pm 10$	10	2.52	17	0.75	95	NLFC322522T-330K-PF
47	$\pm 10$	10	2.52	14	0.95	85	NLFC322522T-470K-PF
68	$\pm 10$	10	2.52	12	1.5	70	NLFC322522T-680K-PF
100	$\pm 10$	10	0.796	10	2.5	55	NLFC322522T-101K-PF
150	$\pm 10$	10	0.796	8	3.2	45	NLFC322522T-151K-PF
220	$\pm 10$	10	0.796	7	5.4	35	NLFC322522T-221K-PF
330	$\pm 10$	10	0.796	5	7	30	NLFC322522T-331K-PF
470	$\pm 10$	10	0.796	4	16	25	NLFC322522T-471K-PF
680	$\pm 10$	10	0.796	3	20	20	NLFC322522T-681K-PF
1000	$\pm 10$	10	0.252	2.4	24	15	NLFC322522T-102K-PF

\* Rated current: The smaller value is applied between the values based on inductance change rate (decreased by 10% compared to the nominal inductance value) and the one based on temperature rise (20°C temperature rise by self-heating).

Measuring Instruments

L, Q : HP4194A Impedance/gain-phase analyzer(16085A+16093B+TDK TF-1)

SRF : HP8753C Network analyzer(Zin=Zout=50  $\Omega$ ) Rdc : MATSUSHITA VP-2941A Digital milliohm meter

Wire-wound Surface Mount Small Inductors  
For Signal Lines And DC Power Lines

NL/NLV, NLC/NLCV,  
NLFC/NLHV  
series

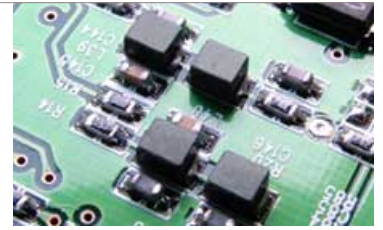

NLFC322522  
series

Inductance vs. frequency characteristics

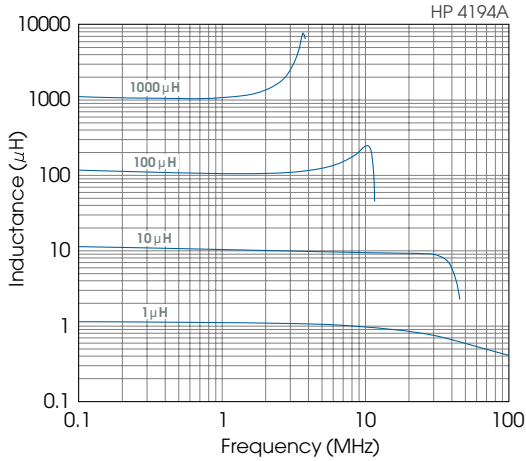

Impedance vs. frequency characteristics

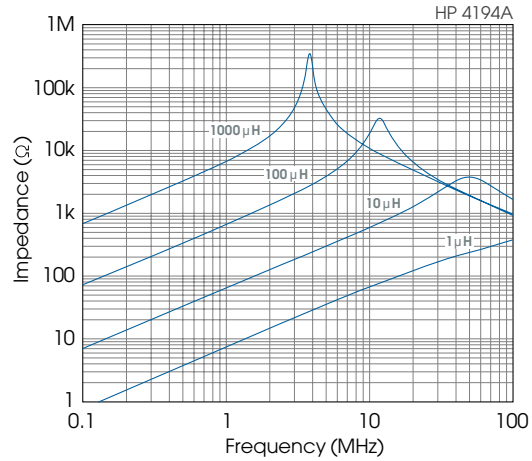

Inductance change vs.  
DC superposition characteristics

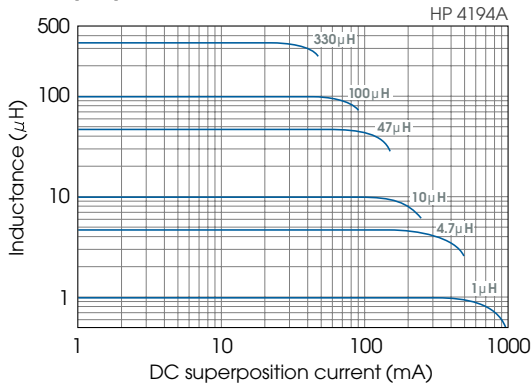

Q vs. frequency characteristics

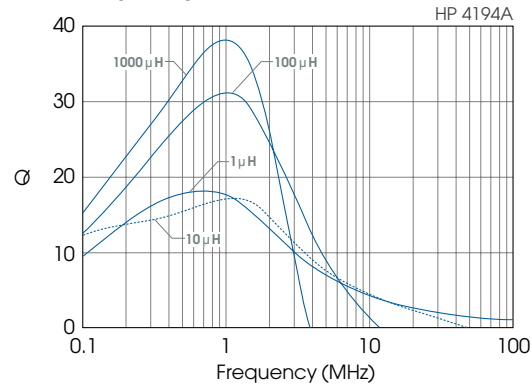

## Product type data

### Shapes and dimensions / Recommended PC board pattern

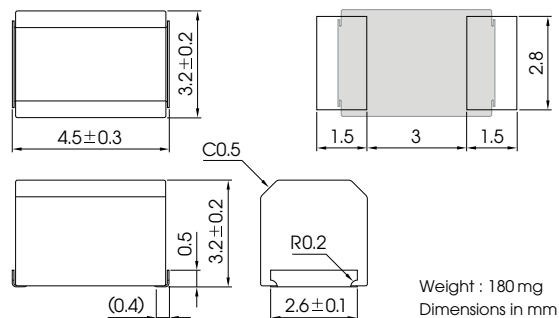

## NLFC453232 series



Wide  
L-value range  
High Q  
Narrow tolerances  
For signal lines  
**NL/NLV**



Large current  
choke  
For power lines  
**NLC/NLCV**



Low Rdc  
choke  
For power lines  
**NLFC/NLFCV**



### Electrical characteristics

Inductance (μH)	Inductance tolerance (%)	Q min.	L, Q test frequency (MHz)	Self-resonance frequency (MHz) min.	DC resistance (Ω) max.	Rated current* (mA) max.	Part No.
1	±20	10	7.96	200	0.05	800	NLFC453232T-1R0M-PF
1.5	±20	10	7.96	130	0.06	700	NLFC453232T-1R5M-PF
2.2	±20	10	7.96	80	0.07	600	NLFC453232T-2R2M-PF
3.3	±20	10	7.96	45	0.09	460	NLFC453232T-3R3M-PF
4.7	±20	10	7.96	35	0.1	400	NLFC453232T-4R7M-PF
6.8	±20	10	7.96	28	0.14	300	NLFC453232T-6R8M-PF
10	±10	10	2.52	22	0.21	250	NLFC453232T-100K-PF
15	±10	10	2.52	20	0.3	200	NLFC453232T-150K-PF
22	±10	10	2.52	18	0.46	170	NLFC453232T-220K-PF
33	±10	10	2.52	14	0.63	140	NLFC453232T-330K-PF
47	±10	10	2.52	11.5	0.85	120	NLFC453232T-470K-PF
68	±10	10	2.52	10	1.2	100	NLFC453232T-680K-PF
100	±10	10	0.796	8	1.	90	NLFC453232T-101K-PF
150	±10	10	0.796	7	2.3	65	NLFC453232T-151K-PF
220	±10	10	0.796	5.5	3.8	55	NLFC453232T-221K-PF
330	±10	10	0.796	4	6	45	NLFC453232T-331K-PF

\* Rated current : The smaller value is applied between the values based on inductance change rate (decreased by 10% compared to the nominal inductance value) and the one based on temperature rise (20°C temperature rise by self-heating).

Measuring Instruments

L, Q : HP4194A Impedance/gain-phase analyzer(16085A+16093B+TDK TF-1)

SRF : HP8753C Network analyzer (Zin=Zout=50 Ω) Rdc : MATSUSHITA VP-2941A Digital milliohm meter

Wire-wound Surface Mount Small Inductors  
For Signal Lines And DC Power Lines

NL/NLV, NLC/NLCV,  
NLFC/NLFV  
series



NLFC453232



series

Inductance vs. frequency characteristics

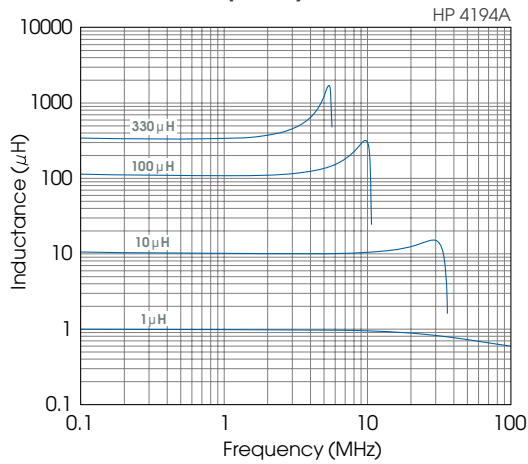

Impedance vs. frequency characteristics

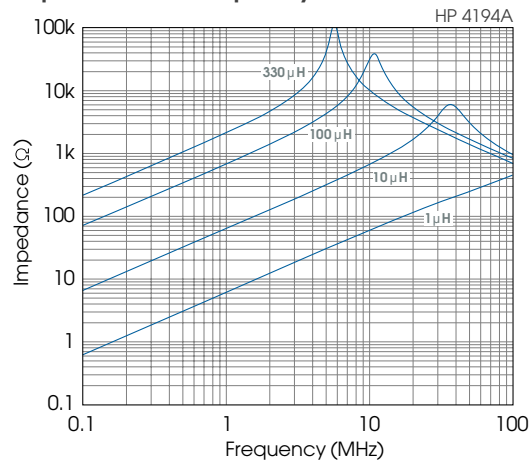

Inductance change vs.  
DC superposition characteristics

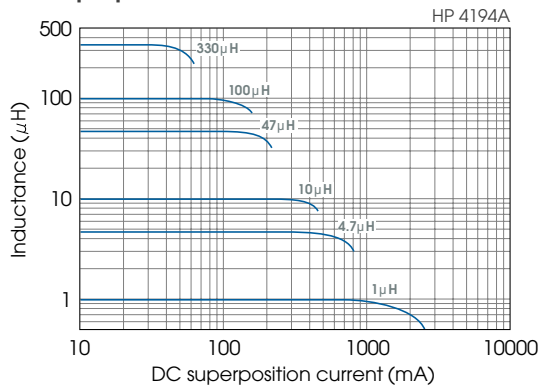

Q vs. frequency characteristics

