

INTRODUCTION

Ceramic chips consist of formulated ceramic dielectric materials which have been fabricated into thin layers, interspersed with metal electrodes alternately exposed on opposite edges of the laminated structure. The entire structure is then fired at high temperature to produce a monolithic block which provides high capacitance values in a small physical volume. After firing, conductive terminations are applied to opposite ends of the chip to make contact with the exposed electrodes. Standard end terminations use a nickel barrier layer and a tin overplate to provide excellent solderability for the customer.

KEMET multilayer ceramic chip capacitors are produced in plants designed specifically for chip capacitor manufacture. The process features a high degree of mechanization as well as precise controls over raw materials and process conditions. Manufacturing is supplemented by extensive Technology, Engineering and Quality Assurance programs.

KEMET ceramic chip capacitors are offered in the five most popular temperature characteristics. These are designated by the Electronics Industries Association (EIA) as the ultra-stable C0G (also known as NP0, military version BP), the stable X7R (military BX or BR), the stable X5R, and the general purpose Z5U and Y5V. A wide range of sizes are available. KEMET multilayer ceramic chip capacitors are available in KEMET's tape and reel packaging, compatible with automatic placement equipment. Bulk cassette packaging is also available (0805,0603 and 0402 only) for those pick and place machines requiring its use.

ELECTRICAL CHARACTERISTICS

1. Working Voltage:

Refers to the maximum continuous DC working voltage permissible across the entire operating temperature range. The reliability of multilayer ceramic capacitors is not extremely sensitive to voltage, and brief applications of voltage above rated will not result in immediate failure. However, reliability will be degraded by sustained exposure to voltages above rated.

2. Temperature Characteristics:

Within the EIA classifications, various temperature characteristics are identified by a three-symbol code; for example: C0G, X7R, X5R, Z5U and Y5V.

For Class I temperature compensating dielectrics (includes C0G), the first symbol designates the significant figures of the temperature coefficient in PPM per degree Celsius, the second designates the multiplier to be applied, and the third designates the tolerance in PPM per degrees Celsius. EIA temperature characteristic codes for Class I dielectrics are shown in Table 1.

Table 1 – EIA Temperature Characteristic Codes for Class I Dielectrics

Significant Figure of Temperature Coefficient		Multiplier Applied to Temperature Coefficient		Tolerance of Temperature Coefficient	
PPM per Degree C	Letter Symbol	Multiplier	Number Symbol	PPM per Degree C	Letter Symbol
0.0	C	-1	0	± 30	G
0.3	B	-10	1	± 60	H
0.9	A	-100	2	± 120	J
1.0	M	-1000	3	± 250	K
1.5	P	-10000	4	± 500	L

KEMET supplies the C0G characteristic.

For Class II and III dielectrics (including X7R, X5R, Z5U & Y5V), the first symbol indicates the lower limit of the operating temperature range, the second indicates the upper limit of the operating temperature range, and the third indicates the maximum capacitance change allowed over the operating temperature range. EIA type designation codes for Class II and III dielectrics are shown in Table 2.

Table 2 – EIA Temperature Characteristic Codes for Class II & III Dielectrics

Low Temperature Rating		High Temperature Rating		Maximum Capacitance Shift		
Degree Celsius	Letter Symbol	Degree Celsius	Number Symbol	Percent	Letter Symbol	EIA Class
+10C	Z	+45C	2	± 1.0%	A	II
-30C	Y	+65C	4	± 1.5%	B	II
-55C	X	+85C	5	± 2.2%	C	II
		+105C	6	± 3.3%	D	II
		+125C	7	± 4.7%	E	II
		+150C	8	± 7.5%	F	II
		+200C	9	± 10.0%	P	II
				± 15.0%	R	II
				± 22.0%	S	III
				+ 22/-33%	T	III
				+22/-56%	U	III
				+22/-82%	V	III

KEMET supplies the X7R, X5R, Z5U and Y5V characteristics.

3. Capacitance Tolerance:

See tables on pages 73-76.

4. Capacitance:

Within specified tolerance when measured per Table 3.

The standard unit of capacitance is the farad. For practical capacitors, capacitance is usually expressed in microfarads (10^{-6} farad), nanofarads (10^{-9} farad), or picofarads (10^{-12} farad). Standard measurement conditions are listed in Table 3 - Specified Electrical Limits.

Like all other practical capacitors, multilayer ceramic capacitors also have resistance and inductance. A simplified schematic for the single frequency equivalent circuit is shown in Figure 1. At high frequency more complex models apply - see KEMET SPICE models at www.kemet.com for details.

Ceramic Surface Mount

Figure 1

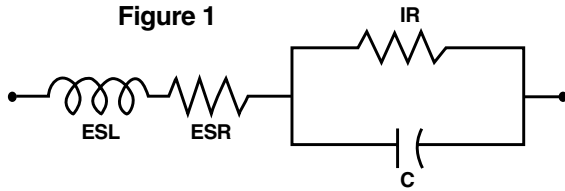

C = Capacitance
ESL = Equivalent Series Inductance
ESR = Equivalent Series Resistance
IR = Insulation Resistance

5. Dissipation Factor:
Measured under same conditions as capacitance. (See Table 3)

Dissipation factor (DF) is a measure of the losses in a capacitor under AC application. It is the ratio of the equivalent series resistance to the capacitive reactance, and is usually expressed in percent. It is normally measured simultaneously with capacitance, and under the same conditions. The vector diagram below illustrates the relationship between DF, ESR and impedance. The reciprocal of the dissipation factor is called the “Q” or quality factor. For convenience, the “Q” factor is often used for very low values of dissipation factor especially when measured at high frequencies. DF is sometimes called the “loss tangent” or “tangent δ”, as shown in Figure 2.

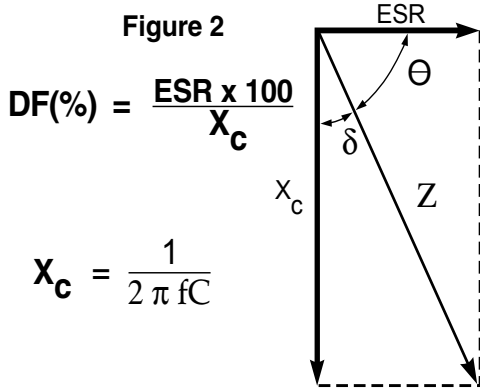

6. Impedance:

Since the parallel resistance (IR) is normally very high, the total impedance of the capacitor can be approximated by:

Figure 3

$$Z = \sqrt{ESR^2 + (X_L - X_C)^2}$$

Where: Z = Total Impedance

ESR = Equivalent Series Resistance

X_C = Capacitive Reactance = $1/(2 \pi f C)$

X_L = Inductive Reactance = $(2 \pi f) (ESL)$

The variation of a capacitor's impedance with frequency determines its effectiveness in many applications. At high frequency more detailed models apply - see KEMET SPICE models for such instances.

7. Insulation Resistance:

Measured after 2 minutes electrification at 25°C and rated voltage: Limits per Table 3.

Insulation Resistance is the measure of a capacitor to resist the flow of DC leakage current. It is sometimes referred to as “leakage resistance”. Insulation resistance (IR) is the DC resistance measured across the terminals of a capacitor, represented by the parallel resistance (IR) shown in Figure 1. For a given dielectric type, electrode area increases with capacitance, resulting in a decrease in the insulation resistance. Consequently, insulation resistance limits are usually specified as the “RC” (IR x C) product, in terms of ohm-farads or megohm-micro-farads. The insulation resistance for a specific capacitance value is determined by dividing this product by the capacitance. However, as the nominal capacitance values become small, the insulation resistance calculated from the RC product reaches values which are impractical. Consequently, IR specifications usually include both a minimum RC product and a maximum limit based on the IR calculated

Table 3 – Specified Electrical Limits

Parameter	Temperature Characteristics			
	C0G	X7R/X5R	Z5U	Y5V
Capacitance & Dissipation Factor: Measured at following conditions: C0G – 1kHz and 1 vrms if capacitance >1000 pF 1MHz and 1 vrms if capacitance ≤1000 pF X7R/X5R/Y5V – 1kHz and 1 vrms* if capacitance ≤ 10 μF X7R/X5R/Y5V – 120Hz and 0.5 vrms if capacitance > 10 μF Z5U – 1kHz and 0.5 vrms				
DF Limits: **X5R Cap DF 50 - 200 volts – <25V <564 5.0% 25 volts – <25V ≥564 10.0% 16 volts – 6.3/10 volts –	0.10% 0.10% ----- -----	2.5% 2.5% 3.5% 5.0% 3.5% ** 5.0% **	4.0% 4.0% -----	5.0% 7.0% 7.0% 10.0%
Dielectric Strength: At 2.5 times rated DC voltage	Pass Subsequent IR Test			
Insulation Resistance (IR): At rated DC voltage, whichever of the two is smaller. To get IR limit, divide MΩ-μF value by the capacitance and compare to GΩ limit. Select the lower of the two limits.	1,000 MΩ – μF or 100 GΩ (100,000 MΩ)	1,000 MΩ – μF or 100 GΩ (100,000 MΩ)	100 MΩ – μF or 10 GΩ (10,000 MΩ)	100 MΩ – μF or 10 G (≥16 volt) 50 MΩ – μF or 10G (≤10v) (10,000 MΩ)
Temperature: Range, °C Capacitance Change (without DC voltage)	-55 to +125 0 ± 30 ppm/°C	X7R: -55 to +125 ±15% X5R: -55 to +85 ±15%	+10 to +85 +22% -56%	-30 to +85 +22% -82%

*Note: Some values measured at ½ volt, see X7R Table for specific details on pages 74 and 75.

from that value. For example, a typical IR specification might read “1,000 megohm-microfarads or 100 gigohms, whichever is less”. The DC leakage current may be calculated by dividing the applied voltage by the insulation resistance (Ohm’s Law).

8. Dielectric Withstanding Voltage:
250% of rated voltage for 5 seconds with current limited to 50mA at 25°C. Limits per Table 3.

Dielectric withstanding voltage (DWV) is the peak DC voltage which a capacitor is designed to withstand without damage for short periods of time. All KEMET multilayer ceramic surface mount capacitors will withstand a DC test voltage of 2.5 x the rated voltage for 60 seconds.

KEMET specification limits for all electrical characteristics at standard measurement conditions are shown in Table 3. Variations in these properties caused by changing conditions (temperature, voltage, frequency, and time) are covered in the following sections.

9. Aging Rate:
Maximum % Capacitance Loss/Decade Hour
COG - 0%
X7R - 2.0%
X5R - 5.0%
Z5U - 7.0%
Y5V - 7.0%
Actual rates may be lower. Consult factory for details.

The capacitance of Class II and III dielectric changes with time as well as with temperature, voltage and frequency. The change with time is known as “aging”. It is caused by gradual realignment of the crystalline structure of the ceramic dielectric material as it is cooled below its Curie temperature, which produces a loss of capacitance with time. The aging process is predictable and follows a logarithmic decay.

The aging process is reversible. If the capacitor is heated to a temperature above its Curie point for some period of time, de-aging will occur and the capacitor will regain the capacitance lost during the aging process. The amount of de-aging depends on both the elevated temperature and the length of time at that temperature. Exposure to 150°C for one-half hour is sufficient to return the capacitor to its initial value.

Because the capacitance changes rapidly immediately after de-aging, capacitance measurements are indexed to a referee time of 1,000 hours. All Kemet capacitors are shipped to be within tolerance at the referee time of 1,000 hours after the deaging process (this time is often referred to as “last heat”). The selection of this referee time has proven practical, as the actual decline of capacitance after 1,000 hours is very low.

10. Effect of Temperature:

Both capacitance and dissipation factor are affected by variations in temperature. The maximum capacitance change with temperature is defined by the temperature characteristic.

However, this only defines an “envelope” bounded by the upper and lower operating temperatures and the minimum and maximum capacitance values. Within this “envelope”, the variation with temperature depends upon the specific dielectric formulation.

Insulation resistance decreases with increasing temperature. Typically, the insulation resistance limit at maximum rated temperature is 10% of the 25°C value.

11. Effect of Voltage:

Certain high dielectric constant ceramic capacitors may show variation in values of capacitance and dissipation factor with various levels of applied AC and DC voltages. Such variation is a natural characteristic of ceramic capacitors, and should be considered by the circuit designer.

In general, ceramic capacitors with the lowest dielectric constant (COG or NP0) are extremely stable, and show little or no variation in capacitance and/or dissipation factor. On the other hand, ceramic capacitors with the highest dielectric constant (Z5U & Y5V) may show significant variation, particularly in capacitance. Other dielectric formulations such as X7R and X5R will show less variation than Y5V, but more than COG.

The application of AC voltages in the range of 10 to 20 VAC tends to increase the values of both the capacitance and dissipation factor, while higher AC voltages tend to produce decreases in both.

However, the variation of capacitance with applied DC is the parameter of most interest to design engineers. Figure 8 shows typical variation of capacitance with applied DC voltage for some standard dielectrics. As can be seen, the decrease in capacitance is greatest for the Y5V dielectric (the COG is not plotted, since it would not have a perceptible capacitance nor dissipation factor change.)

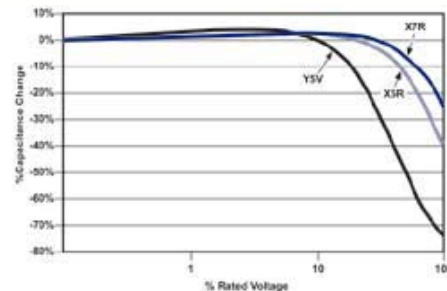

Figure 8 - Typical Variation of Capacitance with Applied DC Voltage (dissipation factor change.)

More detailed modelling information on the effect of various voltages on specific capacitor ratings can be obtained by use of the KEMET SPICE models, available for free downloading at our website (www.kemet.com).

12. Effect of Frequency:

Frequency affects both capacitance and dissipation factor. Typical curves for KEMET multilayer ceramic capacitors are shown in Figures 4, 5, 6 and 7.

The variation of impedance with frequency is an important consideration in the application of multilayer ceramic capacitors. Total impedance of the capacitor is

the vector summation of the capacitive reactance, the inductive reactance, and the ESR, as illustrated in Figure 2. As frequency increases, the capacitive reactance decreases. However, the series inductance (L) shown in Figure 1 produces some inductive reactance, which increases with frequency. At some frequency, the impedance ceases to be capacitive and becomes inductive. This point, at the bottom of the V-shaped impedance versus frequency curves, is the self-resonant frequency. At the self-resonant frequency, the reactance is zero, and the impedance consists of the ESR only. At high frequency more detailed models apply - See KEMET SPICE models for such instances.

Typical impedance versus frequency curves for KEMET multilayer ceramic capacitors are shown in Figures 4, 5, 6 and 7.

ENVIRONMENTAL AND PHYSICAL

- 13. **Thermal Shock:**
EIA-198, Method 202, Condition B (5 cycles -55° to + 125°C).
- 14. **Life Test:**
EIA-198, Method 201, 1000 hours at 200%* of rated voltage at 125°C. (Except 85°C for Z5U, Y5V & X5R).
See Table 4 on page 71 for limits.
*Note: 150% of rated voltage for selected high capacitance X5R values. Please contact factory.
- 15. **Humidity Test:**
EIA-198, Method 206, (Except 1000 hours,85°C, 85% RH, Rated Voltage).
See Table 4 on page 71 for limits.
- 16. **Moisture Resistance:**
EIA-198, Method 204, Condition B (20 cycles with 50 volts applied).
See Table 4 on page 71 for limits.
- 17. **Solderability:**
EIA-198, Method 301 (245°, 5 secs, Sn62 solder) 95% smooth solder on terminations. See page 14 for recommended profiles.
- 18. **Resistance to Soldering Heat:**
EIA-198, Method 302, Condition B (260°C, 10 seconds) no leaching of nickel barrier.
- 19. **Terminal Strength:**
EIA-198, Method 303, Condition D .

RELIABILITY

- 20. A well constructed multilayer ceramic capacitor chip is extremely reliable and, for all practical purposes, has no wearout mechanism when used within the maximum voltage and temperature ratings. Most failures occur as a result of mechanical or thermal damage during mounting on the board, or during subsequent testing. Capacitor failure may also be induced by sustained operation at voltages that exceed the rated DC voltage, voltage spikes or transients that exceed the dielectric's voltage capability, sustained operation at temperatures above the maximum rated temperature, internal defects, or excessive temperature rise due to power

dissipation. As with any practical device, multilayer ceramic capacitors also possess an inherent, although low, failure rate when operated within rated conditions. The primary failure mode is by short-circuit or low insulation resistance, resulting from cracks or from dielectric breakdown at a defect site. KEMET monitors reliability with a periodic sampling program for selected values. Results are available in our FIT (Failure in Time) report for commercial chips.

21. Storage and Handling:

Ceramic chip capacitors should be stored in normal working environments. While the chips themselves are quite robust in other environments, solderability will be degraded by exposure to high temperatures, high humidity, corrosive atmospheres, and long term storage. In addition, packaging materials will be degraded by high temperature – reels may soften or warp, and tape peel force may increase. KEMET recommends that maximum storage temperature not exceed 40 degrees C, and maximum storage humidity not exceed 70% relative humidity. In addition, temperature fluctuations should be minimized to avoid condensation on the parts, and atmospheres should be free of chlorine and sulfur bearing compounds. For optimized solderability, chip stock should be used promptly, preferably within 1.5 years of receipt.

MISAPPLICATION

- 22. Ceramic capacitors, like any other capacitors, may fail if they are misapplied. Some misapplications include mechanical damage, such as impact or excessive flexing of the circuit board. Others include severe mounting or rework cycles that may also introduce thermal shock. Still others include exposure to excessive voltage, current or temperature. If the dielectric layer of the capacitor is damaged by misapplication, the circuit may fail. The electrical energy of the circuit can be released as heat, which may damage the circuit board and other components as well.

ADDITIONAL INFORMATION

- 23. Detailed application information can be found in KEMET Engineering Bulletins.
 - F-2100 Surface Mount-Mounting Pad Dimensions and Considerations
 - F-2102 Reflow Soldering Process
 - F-2105 Wave Solder Process
 - F-2103 Surface Mount Repair
 - F-2110 Capacitance Monitoring while Flex Testing
 - F-2111 Ceramic Chip Capacitors "Flex Cracks" - Understanding and Solutions

For analysis of high frequency applications, KEMET has SPICE models of most chip capacitors. Models may be downloaded from KEMET's website www.kemet.com.

Additional information is also available - See your KEMET representative for details or post your questions to KEMET's homepage on the web <http://www.kemet.com>.

TABLE 4 – ENVIRONMENTAL LIMITS

Body	Rated DC Voltage	Initial DF (%)	IR (GΩ or ΩF) whichever is less	DF (%) Post Life/ Hum/Moisture Resistance	Cap Shift (% or pf, whichever is greater) Post Life/ Hum/Moisture Resistance	IR (GΩ or ΩF) whichever is less Post Life/ Hum/Moisture Resistance
C0G	200*	0.1	100/1000	0.5	0.3% or ± 0.25 pf	10/100
	100	0.1	100/1000	0.5	0.3% or ± 0.25 pf	10/100
	50	0.1	100/1000	0.5	0.3% or ± 0.25 pf	10/100
	25	0.1	100/1000	0.5	0.3% or ± 0.25 pf	10/100
	16	0.1	100/1000	0.5	0.3% or ± 0.25 pf	10/100
X7R	200*	2.5	100/1000	3.0	± 20%	10/100
	100	2.5	100/1000	3.0	± 20%	10/100
	50	2.5	100/1000	3.0	± 20%	10/100
	25	3.5	100/1000	5.0	± 20%	10/100
	16	3.5	100/1000	5.0	± 20%	10/100
	6.3/10	5.0	100/1000	7.5	± 20%	10/100
X5R	50V all cap values	2.5	100/1000	3.0	± 20%	10/100
	25V all cap values	5.0	100/1000	7.5	± 20%	10/100
	<25≤564 cap value	5.0	100/1000	7.5	± 20%	10/100
	>564 cap value	10.0	100/1000	12.0	± 20%	10/100
Z5U	100	4.0	10/100	5.0	± 30%	1/10
	50	4.0	10/100	5.0	± 30%	1/10
	25	4.0	10/100	7.5	± 30%	1/10
Y5V	100	5.0	10/100	7.5	± 30%	1/10
	50	5.0	10/100	7.5	± 30%	1/10
	25	7.0	10/100	10.0	± 30%	1/10
	16	7.0	10/100	10.0	± 30%	1/10
	6.3/10	10.0	10/50	15.0	± 30%	1/5

*200 Volt limits not currently included in EIA-198.

PERFORMANCE CURVES EFFECT OF FREQUENCY (See SPICE models for specific ratings.)

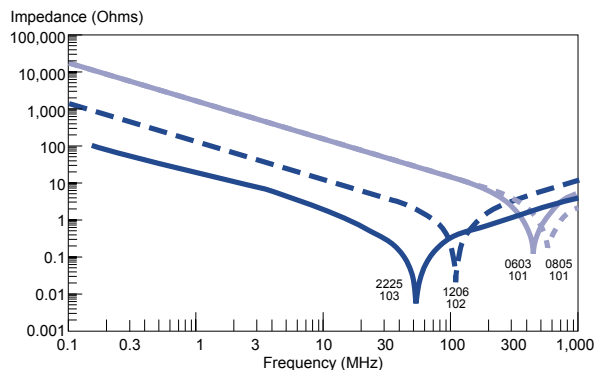

FIGURE 4. Impedance versus Frequency C0G Dielectric

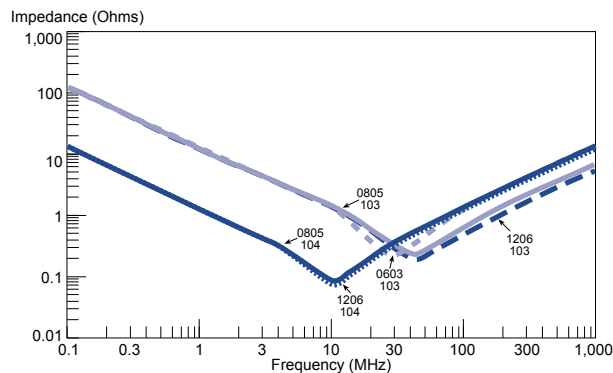

FIGURE 5. Impedance versus Frequency X7R Dielectric

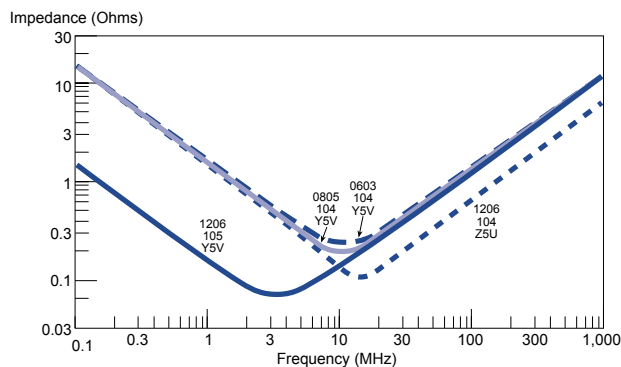

FIGURE 6. Impedance versus Frequency Z5U/Y5V Dielectric

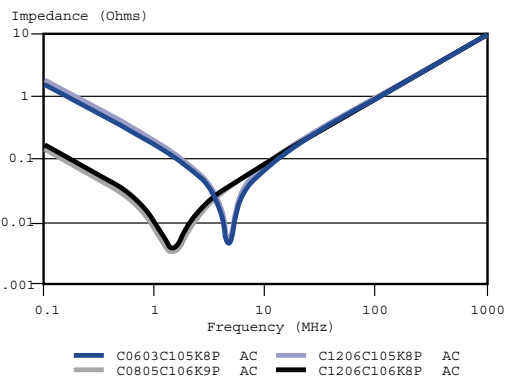

FIGURE 7. Impedance versus Frequency X5R Dielectric

Ceramic Surface Mount

FEATURES

- C0G (NP0), X7R, X5R, Z5U and Y5V Dielectrics
- 10, 16, 25, 50, 100 and 200 Volts
- Standard End Metallization: Tin-plate over nickel barrier
- Available Capacitance Tolerances: ± 0.10 pF; ± 0.25 pF; ± 0.5 pF; $\pm 1\%$; $\pm 2\%$; $\pm 5\%$; $\pm 10\%$; $\pm 20\%$; and $+80\%$ - 20%
- Tape and reel packaging per EIA481-1. (See page 92 for specific tape and reel information.) Bulk Cassette packaging (0402, 0603, 0805 only) per IEC60286-6 and EIAJ 7201.
- RoHS Compliant

CAPACITOR OUTLINE DRAWINGS

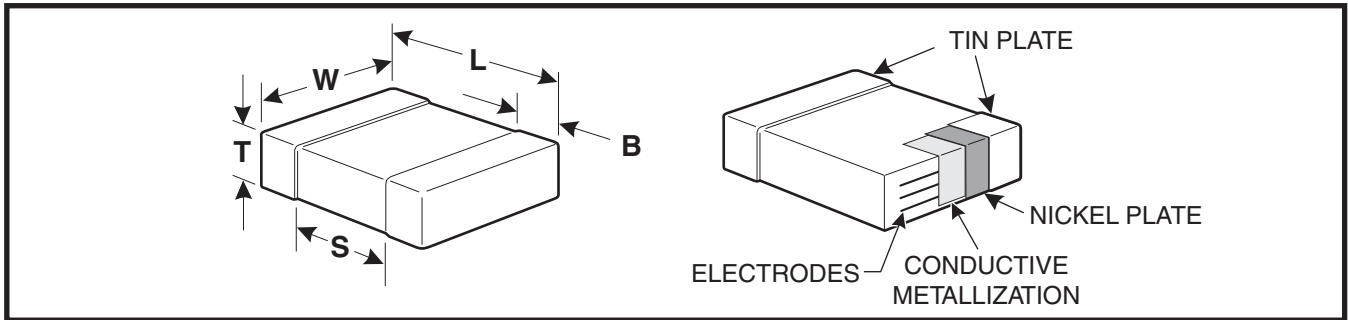

DIMENSIONS—MILLIMETERS AND (INCHES)

EIA SIZE CODE	METRIC SIZE CODE	L - LENGTH	W - WIDTH	T THICKNESS	B - BANDWIDTH	S SEPARATION minimum	MOUNTING TECHNIQUE
0201*	0603	0.6 (.024) \pm .03 (.001)	0.3 \pm (.012) \pm .03 (.001)	See page 78 for thickness dimensions.	0.15 (.006) \pm .05 (.002)	N/A	Solder Reflow
0402*	1005	1.0 (.04) \pm .05 (.002)	0.5 (.02) \pm .05 (.002)		0.20 (.008) - .40 (.016)	0.3 (.012)	
0603	1608	1.6 (.063) \pm .15 (.006)	0.8 (.032) \pm .15 (.006)		0.35 (.014) \pm .15 (.006)	0.7 (.028)	Solder Wave + or Solder Reflow
0805*	2012	2.0 (.079) \pm .20 (.008)	1.25 (.049) \pm .20 (.008)		0.50 (.02) \pm .25 (.010)	0.75 (.030)	
1206*	3216	3.2 (.126) \pm .20 (.008)	1.6 (.063) \pm .20 (.008)		0.50 (.02) \pm .25 (.010)	N/A	
1210*	3225	3.2 (.126) \pm .20 (.008)	2.5 (.098) \pm .20 (.008)		0.50 (.02) \pm .25 (.010)	N/A	Solder Reflow
1812	4532	4.5 (.177) \pm .30 (.012)	3.2 (.126) \pm .30 (.012)		0.60 (.024) \pm .35 (.014)	N/A	
1825*	4564	4.5 (.177) \pm .30 (.012)	6.4 (.252) \pm .40 (.016)		0.60 (.024) \pm .35 (.014)	N/A	
2220	5650	5.6 (.220) \pm .40 (.016)	5.0 (.197) \pm .40 (.016)		0.60 (.024) \pm .35 (.014)	N/A	
2225	5664	5.6 (.220) \pm .40 (.016)	6.3 (.248) \pm .40 (.016)		0.60 (.024) \pm .35 (.014)	N/A	

* Note: Indicates EIA Preferred Case Sizes (Tightened tolerances apply for 0402, 0603, and 0805 packaged in bulk cassette, see page 96.)

+ For extended value 1210 case size - solder reflow only.

CAPACITOR ORDERING INFORMATION (Standard Chips - For Military see page 87)

CERAMIC SIZE CODE SPECIFICATION CAPACITANCE CODE CAPACITANCE TOLERANCE

C 0805 C 103 K 5 R A C*

END METALLIZATION
C-Standard (Tin-plated nickel barrier)

FAILURE RATE LEVEL
A- Not Applicable

TEMPERATURE CHARACTERISTIC
Designated by Capacitance Change Over Temperature Range
G - C0G (NP0) (± 30 PPM/ $^{\circ}$ C)
R - X7R ($\pm 15\%$) (-55° C + 125° C)
P - X5R ($\pm 15\%$) (-55° C + 85° C)
U - Z5U ($+22\%$, -56%) ($+10^{\circ}$ C + 85° C)
V - Y5V ($+22\%$, -82%) (-30° C + 85° C)

VOLTAGE
1 - 100V 3 - 25V
2 - 200V 4 - 16V
5 - 50V 8 - 10V
6 - 35V 9 - 6.3V
7 - 4V

CAPACITANCE CODE
Expressed in Picofarads (pF)
First two digits represent significant figures.
Third digit specifies number of zeros. (Use 9 for 1.0 through 9.9pF. Use 8 for 0.5 through 0.99pF)
(Example: 2.2pF = 229 or 0.50 pF = 508)

CAPACITANCE TOLERANCE
B - ± 0.10 pF J - $\pm 5\%$
C - ± 0.25 pF K - $\pm 10\%$
D - ± 0.5 pF M - $\pm 20\%$
F - $\pm 1\%$ P - (GMV) - special order only
G - $\pm 2\%$ Z - $+80\%$, -20%

* Part Number Example: C0805C103K5RAC (14 digits - no spaces)

C0G CAPACITANCE RANGE – 1210, 1812, 1825, 2220, 2225

Cap pF	Cap Code	Cap Tolerance	C1210*						C1812*			C1825*			C2220			C2225		
			10V	16V	25V	50V	100V	200V	50V	100V	200V	50V	100V	200V	50V	100V	200V	50V	100V	200V
0.5-2.4	508-249	D	FB	FB	FB	FB	FB	FB												
2.7-9.1	279-919	D	FB	FB	FB	FB	FB	FB												
10.0-13.0	100-130	D	FB	FB	FB	FB	FB	FB												
15.0-24.0	150-240	D	FB	FB	FB	FB	FB	FB												
27.0-51.0	270-510	D	FB	FB	FB	FB	FB	FB												
56.0-82.0	560-820	F,G,J,K,M	FB	FB	FB	FB	FB	FB												
91.0-360.0	910-361	F,G,J,K,M	FB	FB	FB	FB	FB	FB												
390.0	391	F,G,J,K,M	FB	FB	FB	FB	FB	FB												
430.0	431	F,G,J,K,M	FB	FB	FB	FB	FB	FB												
470.0	471	F,G,J,K,M	FB	FB	FB	FB	FB	FB	GB	GB	GB									
510.0	511	F,G,J,K,M	FB	FB	FB	FB	FB	FB												
560.0	561	F,G,J,K,M	FB	FB	FB	FB	FB	FB	GB	GB	GB									
620.0	621	F,G,J,K,M	FB	FB	FB	FB	FB	FB												
680.0	681	F,G,J,K,M	FB	FB	FB	FB	FB	FB	GB	GB	GB									
750.0	751	F,G,J,K,M	FB	FB	FB	FB	FB	FB												
820.0	821	F,G,J,K,M	FB	FB	FB	FB	FB	FB	GB	GB	GB									
910.0	911	F,G,J,K,M	FB	FB	FB	FB	FB	FB												
1,000.0	102	F,G,J,K,M	FB	FB	FB	FB	FB	FB	GB	GB	GB									
1,100.0	112	F,G,J,K,M	FB	FB	FB	FB	FB	FB												
1,200.0	122	F,G,J,K,M	FB	FB	FB	FB	FB	FB	GB	GB	GB									
1,300.0	132	F,G,J,K,M	FB	FB	FB	FB	FB	FB												
1,500.0	152	F,G,J,K,M	FB	FB	FB	FB	FB	FE	GB	GB	GB									
1,600.0	162	F,G,J,K,M	FB	FB	FB	FB	FB	FE												
1,800.0	182	F,G,J,K,M	FB	FB	FB	FB	FB	FE	GB	GB	GB									
2,000.0	202	F,G,J,K,M	FB	FB	FB	FB	FB	FC												
2,200.0	222	F,G,J,K,M	FB	FB	FB	FB	FB	FC	GB	GB	GB									
2,400.0	242	F,G,J,K,M	FB	FB	FB	FB	FB	FC												
2,700.0	272	F,G,J,K,M	FB	FB	FB	FB	FB	FC	GB	GB	GB									
3,000.0	302	F,G,J,K,M	FB	FB	FB	FB	FB	FC												
3,300.0	332	F,G,J,K,M	FB	FB	FB	FB	FB	FF	GB	GB	GB									
3,600.0	362	F,G,J,K,M	FB	FB	FB	FB	FB	FF												
3,900.0	392	F,G,J,K,M	FB	FB	FB	FB	FB	FF	GB	GB	GB	HB	HB	HB						
4,300.0	432	F,G,J,K,M	FB	FB	FB	FB	FB	FF												
4,700.0	472	F,G,J,K,M	FB	FB	FB	FB	FB	FF	GB	GB	GB	HB	HB	HB						
5,100.0	512	F,G,J,K,M	FB	FB	FB	FB	FB	FG												
5,600.0	562	F,G,J,K,M	FB	FB	FB	FB	FB	FG	GB	GB	GH	HB	HB	HB						
6,200.0	622	F,G,J,K,M	FB	FB	FB	FB	FB	FG												
6,800.0	682	F,G,J,K,M	FB	FB	FB	FB	FB	FC	GB	GB	GJ	HB	HB	HB	JB	JB				
7,500.0	752	F,G,J,K,M	FC	FC	FC	FC	FC	FC												
8,200.0	822	F,G,J,K,M	FC	FC	FC	FC	FC	FC	GB	GB										
9,100.0	912	F,G,J,K,M	FE	FE	FE	FE	FE	FE												
10,000.0	103	F,G,J,K,M	FE	FE	FE	FE	FE	FE	GB	GH	HB	HB	HE	HE	JB	JB	KB	KB	KB	KB
12,000.0	123	F,G,J,K,M	FG	FG	FG	FG	FG	FG	GB	GG	HB	HB	HE	HE	JB	JB	KB	KB	KB	KB
15,000.0	153	F,G,J,K,M	FG	FG	FG	FG	FG	FG			HB	HB	HE	HE	JB	JB	KB	KB	KB	KB
18,000.0	183	F,G,J,K,M	FB	FB	FB	FB	FB	FB			HB	HB	HE	HE	JB	JB	KB	KB	KB	KB
22,000.0	223	F,G,J,K,M	FB	FB	FB	FB	FB	FB			HB	HB	HE	HE	JB	JB	KB	KB	KB	KB
27,000.0	273	F,G,J,K,M	FB	FB	FB	FB	FB	FB			HB	HB	HE	HE	JB	JB	KB	KB	KB	KB
33,000.0	333	F,G,J,K,M	FB	FB	FB	FB	FB	FB			HB	HB	HE	HE	JB	JB	KB	KB	KB	KB
47,000.0	473	F,G,J,K,M	FB	FB	FB	FB	FB	FE												
56,000.0	563	F,G,J,K,M	FB	FB	FB	FB	FB	FF												
68,000.0	683	F,G,J,K,M	FB	FB	FB	FB	FB	FC												
82,000.0	823	F,G,J,K,M	FC	FC	FC	FC	FC	FC												
100,000.0	104	F,G,J,K,M	FE	FE	FE	FE	FE	FM+												
120,000.0	124	F,G,J,K,M	FG	FG	FG	FG	FG	FH												
150,000.0	154	F,G,J,K,M	FH	FH	FH	FH	FH	FH												
220,000.0	224	F,G,J,K,M	FK+	FK+	FK+	FK+	FK+	FK+												

X7R CAPACITANCE RANGE – 0402, 0603, 0805, 1206

Cap pF	Cap Code	Cap Tolerance	C0402					C0603					C0805					C1206										
			6.3V	10V	16V	25V	50V	6.3V	10V	16V	25V	50V	100V	200V	6.3V	10V	16V	25V	50V	100V	200V	6.3V	10V	16V	25V	50V	100V	200V
150	151	K,M,J	BB	BB	BB	BB	BB	BB	BB	BB	BB	BB	BB	BB	BB	BB	BB	BB	BB	BB	BB	BB	BB	BB	BB	BB	BB	BB
180	181	K,M,J	BB	BB	BB	BB	BB	BB	BB	BB	BB	BB	BB	BB	BB	BB	BB	BB	BB	BB	BB	BB	BB	BB	BB	BB	BB	BB
220	221	K,M,J	BB	BB	BB	BB	BB	BB	BB	BB	BB	BB	BB	BB	BB	BB	BB	BB	BB	BB	BB	BB	BB	BB	BB	BB	BB	BB
270	271	K,M,J	BB	BB	BB	BB	BB	BB	BB	BB	BB	BB	BB	BB	BB	BB	BB	BB	BB	BB	BB	BB	BB	BB	BB	BB	BB	BB
330	331	K,M,J	BB	BB	BB	BB	BB	BB	BB	BB	BB	BB	BB	BB	BB	BB	BB	BB	BB	BB	BB	BB	BB	BB	BB	BB	BB	BB
390	391	K,M,J	BB	BB	BB	BB	BB	BB	BB	BB	BB	BB	BB	BB	BB	BB	BB	BB	BB	BB	BB	BB	BB	BB	BB	BB	BB	BB
470	471	K,M,J	BB	BB	BB	BB	BB	BB	BB	BB	BB	BB	BB	BB	BB	BB	BB	BB	BB	BB	BB	BB	BB	BB	BB	BB	BB	BB
560	561	K,M,J	BB	BB	BB	BB	BB	BB	BB	BB	BB	BB	BB	BB	BB	BB	BB	BB	BB	BB	BB	BB	BB	BB	BB	BB	BB	BB
680	681	K,M,J	BB	BB	BB	BB	BB	BB	BB	BB	BB	BB	BB	BB	BB	BB	BB	BB	BB	BB	BB	BB	BB	BB	BB	BB	BB	BB
820	821	K,M,J	BB	BB	BB	BB	BB	BB	BB	BB	BB	BB	BB	BB	BB	BB	BB	BB	BB	BB	BB	BB	BB	BB	BB	BB	BB	BB
1,000	102	K,M,J	BB	BB	BB	BB	BB	BB	BB	BB	BB	BB	BB	BB	BB	BB	BB	BB	BB	BB	BB	BB	BB	BB	BB	BB	BB	BB
1,200	122	K,M,J	BB	BB	BB	BB	BB	BB	BB	BB	BB	BB	BB	BB	BB	BB	BB	BB	BB	BB	BB	BB	BB	BB	BB	BB	BB	BB
1,500	152	K,M,J	BB	BB	BB	BB	BB	BB	BB	BB	BB	BB	BB	BB	BB	BB	BB	BB	BB	BB	BB	BB	BB	BB	BB	BB	BB	BB
1,800	182	K,M,J	BB	BB	BB	BB	BB	BB	BB	BB	BB	BB	BB	BB	BB	BB	BB	BB	BB	BB	BB	BB	BB	BB	BB	BB	BB	BB
2,200	222	K,M,J	BB	BB	BB	BB	BB	BB	BB	BB	BB	BB	BB	BB	BB	BB	BB	BB	BB	BB	BB	BB	BB	BB	BB	BB	BB	BB
2,700	272	K,M,J	BB	BB	BB	BB	BB	BB	BB	BB	BB	BB	BB	BB	BB	BB	BB	BB	BB	BB	BB	BB	BB	BB	BB	BB	BB	BB
3,300	332	K,M,J	BB	BB	BB	BB	BB	BB	BB	BB	BB	BB	BB	BB	BB	BB	BB	BB	BB	BB	BB	BB	BB	BB	BB	BB	BB	BB
3,900	392	K,M,J	BB	BB	BB	BB	BB	BB	BB	BB	BB	BB	BB	BB	BB	BB	BB	BB	BB	BB	BB	BB	BB	BB	BB	BB	BB	BB
4,700	472	K,M,J	BB	BB	BB	BB	BB	BB	BB	BB	BB	BB	BB	BB	BB	BB	BB	BB	BB	BB	BB	BB	BB	BB	BB	BB	BB	BB
5,600	562	K,M,J	BB	BB	BB	BB	BB	BB	BB	BB	BB	BB	BB	BB	BB	BB	BB	BB	BB	BB	BB	BB	BB	BB	BB	BB	BB	BB
6,800	682	K,M,J	BB	BB	BB	BB	BB	BB	BB	BB	BB	BB	BB	BB	BB	BB	BB	BB	BB	BB	BB	BB	BB	BB	BB	BB	BB	BB
8,200	822	K,M,J	BB	BB	BB	BB	BB	BB	BB	BB	BB	BB	BB	BB	BB	BB	BB	BB	BB	BB	BB	BB	BB	BB	BB	BB	BB	BB
10,000	103	K,M,J	BB	BB	BB	BB	BB	BB	BB	BB	BB	BB	BB	BB	BB	BB	BB	BB	BB	BB	BB	BB	BB	BB	BB	BB	BB	BB
12,000	123	K,M,J**	BB	BB	BB	BB	BB	BB	BB	BB	BB	BB	BB	BB	BB	BB	BB	BB	BB	BB	BB	BB	BB	BB	BB	BB	BB	BB
15,000	153	K,M,J**	BB	BB</																								

X5R CAPACITANCE RANGE

Cap pF	Cap Code	Cap Tol.	0201		C0402*			C0603*				C0805*				C1206*					C1210*							
			6.3V	16V	4V	6.3V	10V	16V	6.3V	10V	16V	25V	4V	6.3V	10V	16V	25V	6.3V	10V	16V	25V	50V	6.3V	10V	16V	25V	35V	50V
10,000	103	K,M		AA~																								
12,000	123	K,M																										
15,000	153	K,M																										
18,000	183	K,M																										
22,000	223	K,M																										
27,000	273	K,M																										
33,000	333	K,M																										
39,000	393	K,M																										
47,000	473	K,M																										
56,000	563	K,M																										
68,000	683	K,M																										
82,000	823	K,M																										
100,000	104	K,M	AA~																									
120,000	124	K,M																										
150,000	154	K,M																										
180,000	184	K,M																										
220,000	224	K,M																										
270,000	274	K,M																										
330,000	334	K,M																										
390,000	394	K,M																										
470,000	474	K,M																										
560,000	564	K,M																										
680,000	684	K,M																										
820,000	824	K,M																										
1,000,000	105	K,M																										
1,200,000	125	K,M																										
1,500,000	155	K,M																										
1,800,000	185	K,M																										
2,200,000	225	K,M																										
2,700,000	275	K,M																										
3,300,000	335	K,M																										
4,700,000	475	K,M																										
5,600,000	565	K,M																										
6,800,000	685	K,M																										
8,200,000	825	K,M																										
10,000,000	106	K,M																										
12,000,000	126	K,M																										
15,000,000	156	K,M																										
18,000,000	186	K,M																										
22,000,000	226	K,M																										
27,000,000	276	K,M																										
33,000,000	336	K,M																										
39,000,000	396	K,M																										
47,000,000	476	K,M																										
100,000,000	107	K,M																										

NOTE: For non-standard capacitance values or voltages, contact your local KEMET sales representative.

+Reflow only ° Available M ±20% tolerance only

Improved product with higher ratings and tighter capacitance tolerance product may be substituted within the same size (length, width, and thickness) at KEMET's option. Reels with such substitutions will be marked with the improved KEMET part numbers.

Z5U CAPACITANCE RANGE
(KEMET's Z5U also meets Y5V Characteristics)

Cap pF	Cap Code	Cap Tol.	C0805*		C1206*		C1210*		C1812*		C1825*		C2225	
			50V	100V	50V	100V	50V	100V	50V	100V	50V	100V	50V	100V
6,800	682	M,Z	DC	DC										
8,200	822	M,Z	DC	DC										
10,000	103	M,Z	DC	DC	EB	EB								
12,000	123	M,Z	DC	DC	EB	EB								
15,000	153	M,Z	DC	DC	EB	EB								
18,000	183	M,Z	DC	DC	EB	EB								
22,000	223	M,Z	DC	DC	EB	EB								
27,000	273	M,Z	DC	DC	EB	EB								
33,000	333	M,Z	DC	DC	EB	EB								
39,000	393	M,Z	DD	DD	EB	EC								
47,000	473	M,Z	DD	DD	EB	EC	FB	FB						
56,000	563	M,Z	DD	DD	EB	EB	FB	FB						
68,000	683	M,Z	DD	DD	EB	EB	FB	FB						
82,000	823	M,Z	DD	DD	EB	EB	FB	FC	GB	GB				
100,000	104	M,Z	DD	DD	EB	EB	FB	FD	GB	GB				
120,000	124	M,Z			EC	EC	FB	FD	GB	GB				
150,000	154	M,Z			EC	EC	FC	FD	GB	GB				
180,000	184	M,Z			EC	EC	FC	FC	GB	GB	HB	HB		
220,000	224	M,Z			EC	EC	FC	FC	GB	GB	HB	HB		
270,000	274	M,Z					FC	FC	GB	GB	HB	HB		
330,000	334	M,Z					FD	FD	GB	GB	HB	HB	KB	KC
390,000	394	M,Z					FD	FD	GB	GB	HB	HD	KB	KC
470,000	474	M,Z					FD	FD	GB	GB	HB	HB	KB	KC
560,000	564	M,Z					FD	FD	GC	GC	HB	HB	KB	KC
680,000	684	M,Z					FD	FD	GC	GC	HB	HB	KB	KC
820,000	824	M,Z						FF	GE	GE	HB	HB	KB	KC
1,000,000	105	M,Z						FH	GE	GE	HB	HB	KB	KC
1,200,000	125	M,Z									HB	HB	KB	KC
1,500,000	155	M,Z									HB	HB	KB	KC
1,800,000	185	M,Z									HB	HB	KB	KD
2,200,000	225	M,Z									HB	HB	KB	KD
2,700,000	275	M,Z											KB	KD

NOTE: For non-standard capacitance values or voltages, contact your local KEMET sales representative. 50 Volt Ceramic Chips can be used for 63 volt applications.

* EIA preferred chip sizes

See page 78 for Thickness Code Reference Chart.

FEATURES

KEMET's line of Tin/Lead termination commercial MLCC surface mount capacitors are designed to meet the needs of the commercial, high reliability, and military customer applications where Tin/Lead plating is required. KEMET's Tin/Lead electroplating process is designed to meet a 5% minimum lead content in the termination of the component. As the bulk of the electronics industry marches to RoHS compliance it is important that KEMET provide the Tin/Lead terminated products for our valued high reliability and military customers.

KEMET Tin/Lead MLCC surface mount capacitors are available in standard EIA case sizes from 0402 to 2225 and standard capacitance values in X7R and C0G dielectrics. Voltage ratings range from 6.3V to 200V. To order the Tin/Lead terminations indicate an "L" in the 14th digit of the part number. To request the L Series termination for other surface mount product lines (Open Mode, High Voltage, Arrays, etc.) or for additional dielectrics and higher voltage ratings, please contact the factory or local Sales representative.

CAPACITOR OUTLINE DRAWINGS

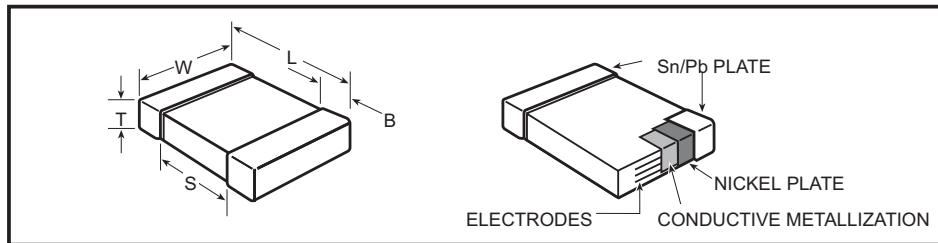

DIMENSIONS—MILLIMETERS AND (INCHES)

EIA SIZE CODE	METRIC SIZE CODE (Ref only)	L # LENGTH	W # WIDTH	See page 78 for thickness dimensions.	B BANDWIDTH		S MIN. SEPARATION		MOUNTING TECHNIQUE
					MIN.	MAX.	MIN.	MAX.	
0402*	1005	1.0 (.04) ± .05 (.002)	0.5 (.02) ± .05 (.002)		0.20 (0.008)-0.40 (0.016)		0.3 (.012)		Solder Reflow
0603*	1608	1.6 (.063) ± 0.15 (.006)	0.8 (.032) ± 0.15 (.006)		0.35 (.014) ± 0.15 (.006)		0.7 (.028)		Solder Wave † or Solder Reflow
0805*	2012	2.0 (.079) ± 0.2 (.008)	1.25 (.049) ± 0.2 (.008)		0.5 (.02) ± .25 (.010)		0.75 (.030)		
1206*	3216	3.2 (.126) ± 0.2 (.008)	1.6 (.063) ± 0.2 (.008)		0.5 (.02) ± .25 (.010)		N/A		
1210*	3225	3.2 (.126) ± 0.2 (.008)	2.5 (.098) ± 0.2 (.008)		0.5 (.02) ± .25 (.010)		N/A		Solder Reflow
1812	4532	4.5 (.177) ± 0.3 (.012)	3.2 (.126) ± 0.3 (.012)		0.6 (.024) ± .35 (.014)		N/A		
1825*	4564	4.5 (.177) ± 0.3 (.012)	6.4 (.252) ± 0.4 (.016)		0.6 (.024) ± .35 (.014)		N/A		
2220	5650	5.6 (.220) ± 0.4 (.016)	5.0 (.197) ± 0.4 (.016)		0.6 (.024) ± .35 (.014)		N/A		
2225	5664	5.6 (.220) ± 0.4 (.016)	6.3 (.248) ± 0.4 (.016)	0.6 (.024) ± .35 (.014)		N/A			

* Note: Indicates EIA Preferred Case Sizes (Tightened tolerances apply for 0402, 0603, and 0805 packaged in bulk cassette, see page 96).
 † For extended value 1210 case size - solder reflow only.

CAPACITOR ORDERING INFORMATION (Standard Chips - For Military see page 87)

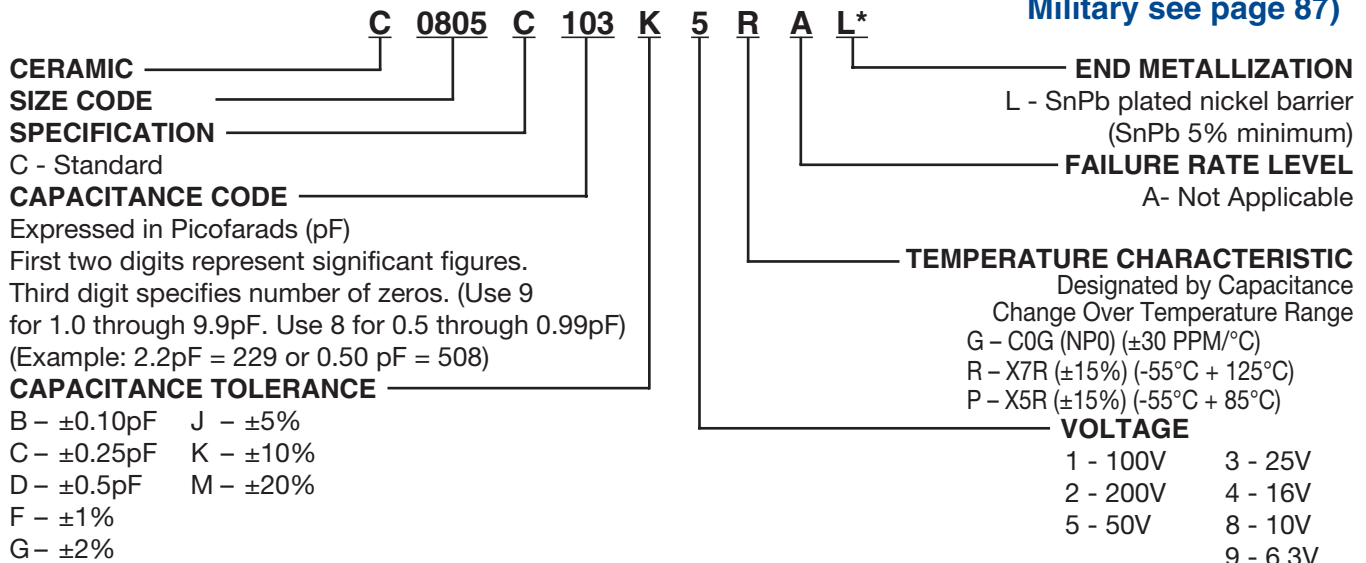

* Part Number Example: C0805C103K5RAL (14 digits - no spaces)

Refer to pages 73-76 for NP0/C0G, X7R and X5R dielectric capacitance ranges available.

©KEMET Electronics Corporation, P.O. Box 5928, Greenville, S.C. 29606, (864) 963-6300

Thickness Code Reference Chart Packaging Quantity Based on Finished Chip Thickness Specifications

Thickness Code	Chip Size	Chip Thickness Range (mm)	Qty per Reel 7" Plastic	Qty per Reel 13" Plastic	Qty per Reel 7" Paper	Qty per Reel 13" Paper	Qty per Bulk Cassette
AA	0201	.30 ± .03	N/A	N/A	15,000	N/A	N/A
BB	0402	.50 ± .05	N/A	N/A	10,000	50,000	50,000
CB	0603	.80 ± .07	N/A	N/A	4,000	10,000	15,000
CC	0603	.80 ± .10	N/A	N/A	4,000	10,000	N/A
CD	0603	.80 ± .15	N/A	N/A	4,000	10,000	N/A
DB	0805	.60 ± .10	N/A	N/A	N/A	N/A	10,000
DC	0805	.78 ± .10	4,000	10,000	4,000	10,000	N/A
DD	0805	.90 ± .10	4,000	10,000	N/A	N/A	N/A
DE	0805	1.00 ± .10	2,500	10,000	N/A	N/A	N/A
DF	0805	1.10 ± .10	2,500	10,000	N/A	N/A	N/A
DG	0805	1.25 ± .15	2,500	10,000	N/A	N/A	N/A
DH	0805	1.25 ± .20	2,500	10,000	N/A	N/A	N/A
DJ	0805	1.25 ± .20	3,000	10,000	N/A	N/A	N/A
DK	0805	1.25 ± .15	3,000	10,000	N/A	N/A	N/A
EB	1206	.78 ± .10	4,000	10,000	4,000	10,000	N/A
EC	1206	.90 ± .10	4,000	10,000	N/A	N/A	N/A
ED	1206	1.00 ± .10	2,500	10,000	N/A	N/A	N/A
EE	1206	1.10 ± .10	2,500	10,000	N/A	N/A	N/A
EF	1206	1.20 ± .15	2,500	10,000	N/A	N/A	N/A
EG	1206	1.60 ± .15	2,000	8,000	N/A	N/A	N/A
EH	1206	1.60 ± .20	2,000	8,000	N/A	N/A	N/A
EJ	1206	1.70 ± .20	2,000	8,000	N/A	N/A	N/A
EK	1206	.80 ± .10	2,000	8,000	N/A	N/A	N/A
EL	1206	1.15 ± .15	2,000	8,000	N/A	N/A	N/A
EM	1206	1.25 ± .15	2,500	10,000	N/A	N/A	N/A
EN	1206	0.95 ± .10	4,000	10,000	N/A	N/A	N/A
FB	1210	.78 ± .10	4,000	10,000	N/A	N/A	N/A
FC	1210	.90 ± .10	4,000	10,000	N/A	N/A	N/A
FD	1210	.95 ± .10	4,000	10,000	N/A	N/A	N/A
FE	1210	1.00 ± .10	2,500	10,000	N/A	N/A	N/A
FF	1210	1.10 ± .10	2,500	10,000	N/A	N/A	N/A
FG	1210	1.25 ± .15	2,500	10,000	N/A	N/A	N/A
FH	1210	1.55 ± .15	2,000	8,000	N/A	N/A	N/A
FJ	1210	1.85 ± .20	2,000	8,000	N/A	N/A	N/A
FK	1210	2.10 ± .20	2,000	8,000	N/A	N/A	N/A
FL	1210	1.40 ± .15	2,000	8,000	N/A	N/A	N/A
FM	1210	1.70 ± .20	2,000	8,000	N/A	N/A	N/A
FN	1210	1.85 ± .20	2,000	8,000	N/A	N/A	N/A
FO	1210	1.50 ± .20	2,000	8,000	N/A	N/A	N/A
FP	1210	1.60 ± .20	2,000	8,000	N/A	N/A	N/A
FQ	1210	2.50 ± .20	1,500	8,000	N/A	N/A	N/A
FR	1210	2.25 ± .20	2,000	8,000	N/A	N/A	N/A
FS	1210	2.50 ± .20	1,000	4,000	N/A	N/A	N/A
FT	1210	1.90 ± .20	1,500	4,000	N/A	N/A	N/A
GB	1812	1.00 ± .10	1,000	4,000	N/A	N/A	N/A
GC	1812	1.10 ± .10	1,000	4,000	N/A	N/A	N/A
GD	1812	1.25 ± .15	1,000	4,000	N/A	N/A	N/A
GE	1812	1.30 ± .10	1,000	4,000	N/A	N/A	N/A
GF	1812	1.50 ± .10	1,000	4,000	N/A	N/A	N/A
GG	1812	1.55 ± .10	1,000	4,000	N/A	N/A	N/A
GH	1812	1.40 ± .15	1,000	4,000	N/A	N/A	N/A
GJ	1812	1.70 ± .15	1,000	4,000	N/A	N/A	N/A
GK	1812	1.60 ± .20	1,000	4,000	N/A	N/A	N/A
GL	1812	1.90 ± .20	1,000	4,000	N/A	N/A	N/A
GM	1812	2.00 ± .20	1,000	4,000	N/A	N/A	N/A
GN	1812	1.70 ± .20	1,000	4,000	N/A	N/A	N/A
GO	1812	2.5 ± .20	500	N/A	N/A	N/A	N/A
HB	1825	1.10 ± .15	1,000	4,000	N/A	N/A	N/A
HC	1825	1.15 ± .15	1,000	4,000	N/A	N/A	N/A
HD	1825	1.30 ± .15	1,000	4,000	N/A	N/A	N/A
HE	1825	1.40 ± .15	1,000	4,000	N/A	N/A	N/A
HF	1825	1.50 ± .15	1,000	4,000	N/A	N/A	N/A
JB	2220	1.00 ± .15	1,000	4,000	N/A	N/A	N/A
JC	2220	1.10 ± .15	1,000	4,000	N/A	N/A	N/A
JD	2220	1.30 ± .15	1,000	4,000	N/A	N/A	N/A
JE	2220	1.40 ± .15	1,000	4,000	N/A	N/A	N/A
JF	2220	1.50 ± .15	1,000	4,000	N/A	N/A	N/A
JG	2220	1.70 ± .15	1,000	4,000	N/A	N/A	N/A
JH	2220	1.80 ± .15	1,000	4,000	N/A	N/A	N/A
JO	2220	2.40 ± .15	1,000	4,000	N/A	N/A	N/A
KB	2225	1.00 ± .15	1,000	4,000	N/A	N/A	N/A
KC	2225	1.10 ± .15	1,000	4,000	N/A	N/A	N/A
KD	2225	1.30 ± .15	1,000	4,000	N/A	N/A	N/A
KE	2225	1.40 ± .15	1,000	4,000	N/A	N/A	N/A

This chart refers to ceramic chip thickness codes on pages 73 – 76.

Note: TU suffix represents tape and reel packaging of unmarked components.

Note: TM suffix represents tape and reel packaging of marked components.

Cases sizes ≤1210 are 8mm tape with 4mm pitch and Case Sizes >1210 are 12mm tape and 8mm pitch.

FEATURES

KEMET's Open Mode Ceramic Surface Mount Capacitor is designed to significantly minimize the probability of a low IR or Short Circuit Condition when forced to failure in a board flex situation. This reduces the potential for causing catastrophic failures. This product is RoHS Compliant.

Applications:

- Input side filtering (power plane/bus)
- High current applications (battery line)
- Circuits that cannot be fused to open when short circuits occur due to flex cracks

Markets:

- *Automotive*
 - All applications connected directly to the battery
 - Conversion to 42V power system
- *Power Conversion*
 - Raw power input side filtering

OUTLINE DRAWING

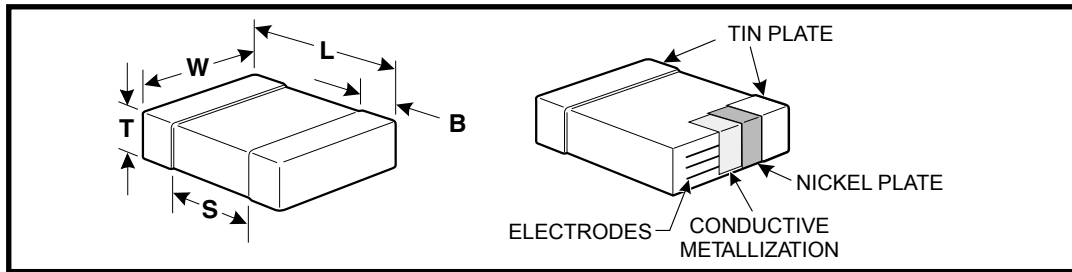
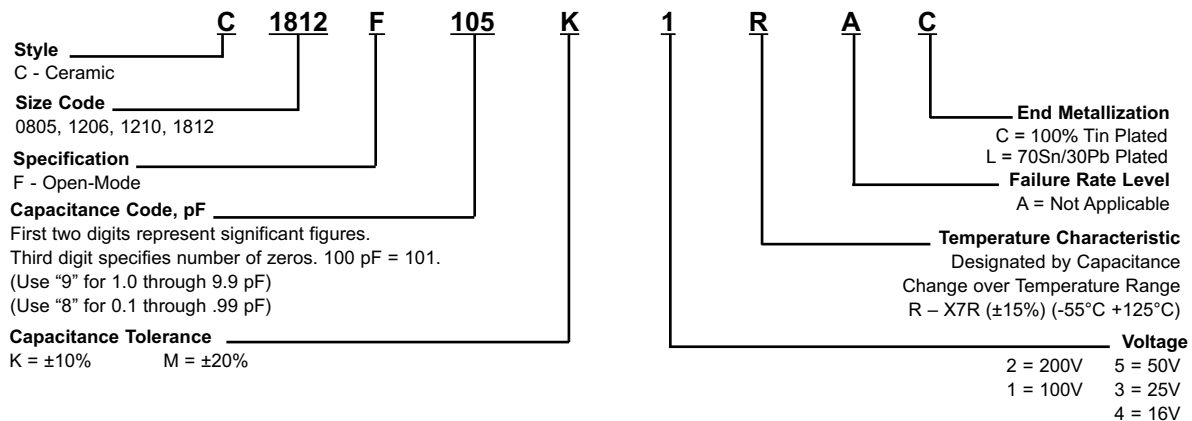

TABLE 1 - DIMENSIONS - MILLIMETERS (INCHES)

Metric Size Code	EIA Size Code	L - Length	W - Width	B - Bandwidth	Separation
2012	0805	2.0 (.079) ± .20 (.008)	1.25 (.049) ± 0.2 (.008)	0.50 (.02) ± .25 (.010)	0.75 (.030)
3216	1206	3.2 (.126) ± .20 (.008)	1.6 (.063) ± 0.2 (.008)	0.50 (.02) ± .25 (.010)	N/A
3225	1210	3.2 (.126) ± .20 (.008)	2.5 (.098) ± 0.2 (.008)	0.50 (.02) ± .25 (.010)	N/A
4532	1812	4.5 (.177) ± 0.3 (.012)	3.2 (.126) ± 0.3 (.012)	0.60 (.024) ± .35 (.014)	N/A

Note: For thickness dimensions, see Table 2.

CAPACITOR ORDERING INFORMATION



OPEN-MODE INTERNAL DESIGN

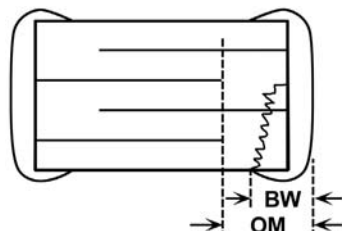

The open-mode dimension (OM) exceeds the termination bandwidth dimensions: OM > BW

Ceramic Surface Mount

TABLE 2
X7R DIELECTRIC CAPACITANCE RANGE AND THICKNESS TARGETS (mm)

Cap Code	0805					1206					1210					1812			
	16V	25V	50V	100V	200V	16V	25V	50V	100V	200V	16V	25V	50V	100V	200V	25V	50V	100V	200V
102	DD	DD	DD	DD	DD														
122	DD	DD	DD	DD	DD														
152	DD	DD	DD	DD	DD														
182	DD	DD	DD	DD	DD														
222	DD	DD	DD	DD	DD														
272	DD	DD	DD	DD	DD														
332	DD	DD	DD	DD	DD														
392	DD	DD	DD	DD	DD														
472	DD	DD	DD	DD	DD														
562	DD	DD	DD	DD	DD														
682	DD	DD	DD	DD	DD														
822	DD	DD	DD	DD	DD														
103	DD	DD	DD	DD	DD														
123	DD	DD	DD	DD	DG														
153	DD	DD	DD	DD	DG														
183	DD	DD	DD	DD						EC									
223	DD	DD	DD	DG						EC									
273	DD	DD	DD	DG						EC									
333	DD	DD	DD	DG						EC									
393	DD	DD	DD	DG						EC									
473	DD	DD	DD	DE		EC	EC	EC	EC	EG									GB
563	DD	DD	DD			EC	EC	EC	EC	EG									GB
683	DD	DD	DG	DG		EC	EC	EC	EC	EG				FD					GB
823	DD	DD	DG			EC	EC	EC	EC	EG				FD					GB
104	DG	DG	DG			EC	EC	EC	EC	EG	FD	FD	FD	FD	FG	GB	GB	GB	GB
124	DG	DG				EC	EC	EC	EC		FD	FD	FD	FD	FG	GB	GB	GB	GB
154	DG	DG				EC	EC	EC	EG		FD	FD	FD	FD	FH	GB	GB	GB	GB
184	DG	DG				EC	EC	EC	EG		FD	FD	FD	FD	FH	GB	GB	GB	GB
224	DG	DD	DG			EC	EC	EC	ED		FD	FD	FD	FG	FJ	GB	GB	GB	GC
274	DD	DD				EC	EC	EC			FD	FD	FD	FG		GB	GB	GB	GF
334	DG	DG				EG	EG	EG	EG		FD	FD	FD	FH		GB	GB	GB	GK
394	DG	DG				EG	EG				FD	FD	FG	FH		GB	GB	GB	GL
474	DE	DG				EG	EG	EC			FD	FD	FG	FJ		GB	GB	GC	
564						EG					FD	FD	FG	FR		GB	GB	GD	
684	DG					EG					FD	FG	FH	FR		GD	GD	GF	
824						EG					FD	FG	FJ			GD	GD	GK	
105						EG	EC	EH			FD	FH	FJ	FQ		GN	GN	GM	
125											FG								
155											FH								
185											FH								
225						EC	EH				FJ		FM						
475						EH					FG	FM							
685											FQ								

THICKNESS AND PACKAGING INFORMATION

Thickness Code	Series	Dimension	7" Reel Qty.	13" Reel Qty.
DD	0805	.90 ± .10	4000	10000
DE	0805	1.00 ± .10	2500	10000
DG	0805	1.25 ± .15	2500	10000
EC	1206	.90 ± .10	4000	10000
EG	1206	1.60 ± .15	2000	8000
EH	1206	1.60 ± .20	2000	8000
FD	1210	.95 ± .10	4000	10000
FG	1210	1.25 ± .15	2500	10000
FH	1210	1.55 ± .15	2000	8000
FJ	1210	1.85 ± .20	2000	8000
FM	1210	1.70 ± .20	2000	8000
FR	1210	2.25 ± .20	2000	8000
FQ	1210	2.5 ± .20	1500	8000
GB	1812	1.0 ± .10	1000	4000
GC	1812	1.1 ± .10	1000	4000
GD	1812	1.25 ± .15	1000	4000
GF	1812	1.50 ± .15	1000	4000
GK	1812	1.60 ± .20	1000	4000
GL	1812	1.90 ± .20	1000	4000
GM	1812	2.00 ± .20	1000	4000
GN	1812	1.70 ± .20	1000	4000

KEMET's High Voltage Surface Mount Capacitors are designed to withstand high voltage applications. They offer high capacitance with low leakage current and low ESR at high frequency. The capacitors have pure tin (Sn) plated external electrodes for good solderability. X7R dielectrics are not designed for AC line filtering applications. An insulating coating may be required to prevent surface arcing. These components are RoHS compliant.

APPLICATIONS

- Switch Mode Power Supply
 - Input Filter
 - Resonators
 - Tank Circuit
 - Snubber Circuit
 - Output Filter
- High Voltage Coupling
- High Voltage DC Blocking
- Lighting Ballast
- Voltage Multiplier Circuits
- Coupling Capacitor/CLK

MARKETS

- Power Supply
- High Voltage Power Supply
- DC-DC Converter
- LCD Fluorescent Backlight Ballast
- HID Lighting
- Telecommunications Equipment
- Industrial Equipment/Control
- Medical Equipment/Control
- Computer (LAN/WAN Interface)
- Analog and Digital Modems
- Automotive

OUTLINE DRAWING

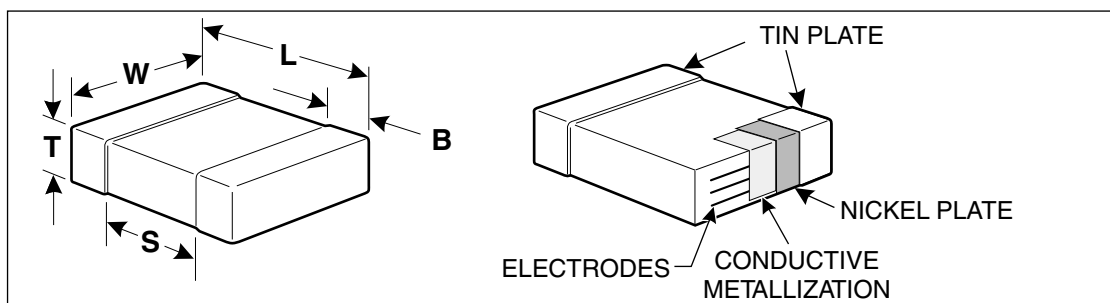

TABLE 1 - DIMENSIONS - MILLIMETERS (in.)

Metric Code	EIA Size Code	L - Length	W - Width	B - Bandwidth	Band Separation
2012	0805	2.0 (0.079) ± 0.2 (0.008)	1.2 (0.049) ± 0.2 (0.008)	0.5 (0.02) ±0.25 (0.010)	0.75 (0.030)
3216	1206	3.2 (0.126) ± 0.2 (0.008)	1.6 (0.063) ± 0.2 (0.008)	0.5 (0.02) ± 0.25 (0.010)	N/A
3225	1210	3.2 (0.126) ± 0.2 (0.008)	2.5 (0.098) ± 0.2 (0.008)	0.5 (0.02) ± 0.25 (0.010)	N/A
4520	1808	4.5 (0.177) ± 0.3 (0.012)	2.0 (0.079) ± 0.2 (0.008)	0.6 (0.024) ± 0.35 (0.014)	N/A
4532	1812	4.5 (0.177) ± 0.3 (0.012)	3.2 (0.126) ± 0.3 (0.012)	0.6 (0.024) ± 0.35 (0.014)	N/A
4564	1825	4.5 (0.177) ± 0.3 (0.012)	6.4 (0.250) ± 0.4 (0.016)	0.6 (0.024) ± 0.35 (0.014)	N/A
5650	2220	5.6 (0.224) ± 0.4 (0.016)	5.0 (0.197) ± 0.4 (0.016)	0.6 (0.024) ± 0.35 (0.014)	N/A
5664	2225	5.6 (0.224) ± 0.4 (0.016)	6.4 (0.250) ± 0.4 (0.016)	0.6 (0.024) ± 0.35 (0.014)	N/A

Ceramic Surface Mount

C0G DIELECTRIC CAPACITANCE VALUES AND THICKNESS TARGETS (in.)

Cap pF	Capacitance Tolerance *	Series	0805		1206			1210			1808			1812			1825			2220			2225		
		Max Thickness (in)	0.050	0.050	0.065	0.065	0.065	0.065	0.065	0.065	0.065	0.065	0.067	0.067	0.067	0.067	0.067	0.067	0.067	0.067	0.067	0.067	0.067		
		Cap Code/ Voltage	500	1000	500	1000	1500	2000	500	1000	1500	2000	500	1000	1500	2000	2500	3000	500	1000	1500	2000	2500	3000	
10-24	C,D																								
2.7-5.1	C,D	K,M	279-519																						
5.6-9.1	C,D	J,K,M	569-919																						
10	C,D	J,K,M	100																						
11	C,D	J,K,M	110																						
12	C,D	J,K,M	120																						
13	C,D	J,K,M	130																						
15	C,D	G,J,K,M	150																						
16	C,D	G,J,K,M	160																						
18	C,D	G,J,K,M	180																						
20	C,D	G,J,K,M	200																						
22	C,D	G,J,K,M	220																						
24	C,D	G,J,K,M	240																						
27	D,F,G,J,K,M		270																						
30	D,F,G,J,K,M		300																						
33	D,F,G,J,K,M		330																						
36	D,F,G,J,K,M		360																						
39	D,F,G,J,K,M		390																						
43	D,F,G,J,K,M		430																						
47	D,F,G,J,K,M		470																						
51	D,F,G,J,K,M		510																						
56	F,G,J,K,M		560																						
62	F,G,J,K,M		620																						
68	F,G,J,K,M		680																						
75	F,G,J,K,M		750																						
82	F,G,J,K,M		820																						
91	F,G,J,K,M		910																						
100	F,G,J,K,M		101																						
110	F,G,J,K,M		111																						
120	F,G,J,K,M		121																						
130	F,G,J,K,M		131																						
150	F,G,J,K,M		151																						
160	F,G,J,K,M		161																						
180	F,G,J,K,M		181																						
200	F,G,J,K,M		201																						
220	F,G,J,K,M		221																						
240	F,G,J,K,M		241																						
270	F,G,J,K,M		271																						
300	F,G,J,K,M		301																						
330	F,G,J,K,M		331																						
360	F,G,J,K,M		361																						
390	F,G,J,K,M		391																						
430	F,G,J,K,M		431																						
470	F,G,J,K,M		471																						
510	F,G,J,K,M		511																						
560	F,G,J,K,M		561																						
620	F,G,J,K,M		621																						
680	F,G,J,K,M		681																						
750	F,G,J,K,M		751																						
820	F,G,J,K,M		821																						
910	F,G,J,K,M		911																						
1000	F,G,J,K,M		102																						
1100	F,G,J,K,M		112																						
1200	F,G,J,K,M		122																						
1300	F,G,J,K,M		132																						
1500	F,G,J,K,M		152																						
1600	F,G,J,K,M		162																						
1800	F,G,J,K,M		182																						
2000	F,G,J,K,M		202																						
2200	F,G,J,K,M		222																						
2400	F,G,J,K,M		242																						
2700	F,G,J,K,M		272																						
3000	F,G,J,K,M		302																						
3300	F,G,J,K,M		332																						
3600	F,G,J,K,M		362																						
3900	F,G,J,K,M		392																						
4300	F,G,J,K,M		432																						
4700	F,G,J,K,M		472																						
5100	F,G,J,K,M		512																						
5600	F,G,J,K,M		562																						
6200	F,G,J,K,M		622																						
6800	F,G,J,K,M		682																						
7500	F,G,J,K,M		752																						
8200	F,G,J,K,M		822																						
9100	F,G,J,K,M		912																						
10,000	F,G,J,K,M		103																						

* Contact KEMET Sales Representative for C, D, F & G Capacitance Tolerance availability.

Note: Actual thickness dimensions may be less than stated maximum. Check the KEMET website, www.kemet.com, for additional values and chip sizes available.

X7R DIELECTRIC CAPACITANCE VALUES AND THICKNESS TARGETS (in.)

Cap pF	Capacitance Tolerance	Series	0805		1206		1210		1808		1812		1825		2220		2225		
		Max Thickness (in)	0.050	0.050	0.065	0.065	0.080	0.080	0.080	0.080	0.080	0.087	0.087	0.087	0.087	0.087	0.087	0.087	0.087
		Cap Code/ Voltage	500	1000	500	1000	1500	2000	500	1000	1500	2000	2500	3000	500	1000	1500	2000	2500
10	J,K,M	100																	
11	J,K,M	110																	
12	J,K,M	120																	
13	J,K,M	130																	
15	J,K,M	150																	
16	J,K,M	160																	
18	J,K,M	180																	
20	J,K,M	200																	
22	J,K,M	220																	
24	J,K,M	240																	
27	J,K,M	270																	
30	J,K,M	300																	
33	J,K,M	330																	
36	J,K,M	360																	
39	J,K,M	390																	
43	J,K,M	430																	
47	J,K,M	470																	
51	J,K,M	510																	
56	J,K,M	560																	
62	J,K,M	620																	
68	J,K,M	680																	
75	J,K,M	750																	
82	J,K,M	820																	
91	J,K,M	910																	
100	J,K,M	101																	
110	J,K,M	111																	
120	J,K,M	121																	
130	J,K,M	131																	
150	J,K,M	151																	
180	J,K,M	181																	
220	J,K,M	221																	
270	J,K,M	271																	
330	J,K,M	331																	
390	J,K,M	391																	
470	J,K,M	471																	
560	J,K,M	561																	
680	J,K,M	681																	
820	J,K,M	821																	
1000	J,K,M	102																	
1200	J,K,M	122																	
1500	J,K,M	152																	
1800	J,K,M	182																	
2000	J,K,M	202																	
2200	J,K,M	222																	
2700	J,K,M	272																	
3300	J,K,M	332																	
3900	J,K,M	392																	
4700	J,K,M	472																	
5600	J,K,M	562																	
6800	J,K,M	682																	
8200	J,K,M	822																	
10,000	J,K,M	103																	
12,000	J,K,M	123																	
15,000	J,K,M	153																	
18,000	J,K,M	183																	
22,000	J,K,M	223																	
27,000	J,K,M	273																	
33,000	J,K,M	333																	
39,000	J,K,M	393																	
47,000	J,K,M	473																	
56,000	J,K,M	563																	
62,000	J,K,M	623																	
68,000	J,K,M	683																	
82,000	J,K,M	823																	
100,000	J,K,M	104																	
120,000	J,K,M	124																	
150,000	J,K,M	154																	
180,000	J,K,M	184																	
220,000	J,K,M	224																	

Note: Actual thickness dimensions may be less than stated maximum.
Check the KEMET website, www.kemet.com, for additional values and chip sizes available.

KEMET HIGH VOLTAGE SURFACE MOUNT CHIP (VOLTAGE CODES C,D,F,G,H, and Z) THICKNESS AND REELING QUANTITIES

Chip size		Max. Thickness (in)	Max. Thickness (mm)	Tape Width (mm)	Qty per Reel 7" Plastic	Qty per Reel 13" Plastic
EIA	Metric					
0805	2012	0.055	1.27	8	2,500	10,000
1206	3216	0.065	1.65	8	2,000	8,000
1210	3225	0.101	2.57	8	2,000	8,000
1808	4520	0.080	2.03	12	1,000	4,000
1812/1813	4532	0.067	1.70	12	1,000	4,000
1825	4564	0.067	1.70	12	1,000	4,000
2220	5650	0.067	1.70	12	1,000	4,000
2225	5664	0.067	1.70	12	1,000	4,000

Ceramic Surface Mount

CAPACITOR ORDERING INFORMATION

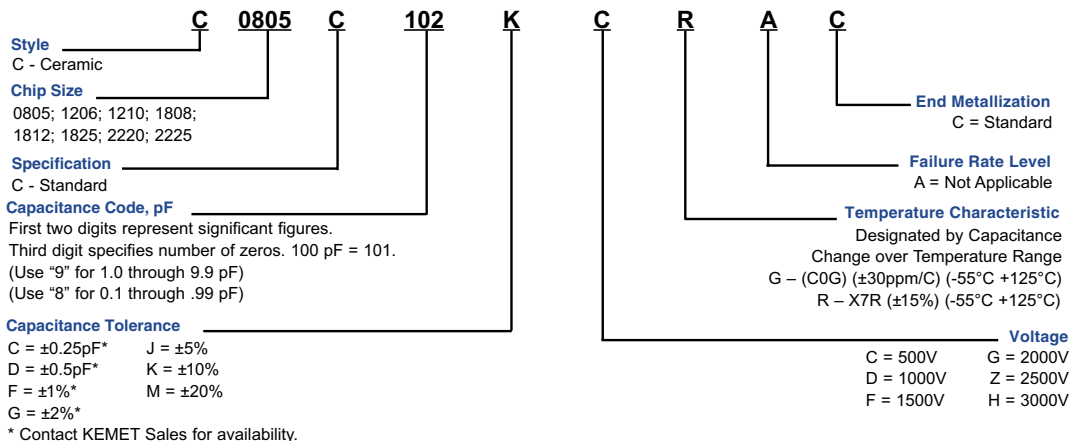

ELECTRICAL PARAMETERS

Property	Specification
Capacitance	C0G: 1 pF to 0.010 µF X7R: 10 pF to 0.22 µF 25°C, 1.0 ± 0.2 Vrms, 1 kHz (1 MHz for ≤ 1000 pF (C0G only))
Cap Tolerance	C0G: C*, D*, F*, G*, J, K, M * Contact KEMET Sales for availability. X7R: J, K, M
DF	C0G: 0.1% Max X7R: 2.5% Max
Voltage Ratings	500 V, 1000 V, 1500 V, 2000 V, 2500 V, 3000 V
Operating Temperature Range	From -55°C to +125°C
25°C IR @ 500V	100 GΩ or 1000 MΩ-µF, whichever is less
125°C IR @ 500V	10 GΩ or 100 MΩ-µF, whichever is less
-55°C TCC +125°C TCC	X7R: ± 15% C0G: ± 30 ppm / °C
Dielectric Strength	150% of Rated Voltage for Rated Voltage <1000 V 120% of Rated Voltage for Rated Voltage ≥1000V
Ripple Current	Consult KEMET Sales Representative

MARKING

These chips are supplied unmarked. If required, they can be supplied LASER-marked at an extra cost. Details on the marking format is located on page 97.

PACKAGING

KEMET High Voltage Surface Mount MLCC are available packaged in tape and reel configuration, or bulk bag as outlined on page 83. Please consult factory for waffle packaging options.

SOLDERING PROCESS

The 0805 and 1206 case sizes are suitable for either reflow or wave soldering processes. Sizes 1210 and larger should be limited to reflow soldering only. All sizes incorporate the standard KEMET barrier layer of pure nickel with an overplating of pure tin (Sn) for excellent solderability and resistance to solder leaching of the termination.

RECOMMENDED SOLDER PAD DIMENSIONS

Chip Size	T (Total Length)		S (Separation)		W (Pad Width)		L (Pad Length)	
	mm	in.	mm	in.	mm	in.	mm	in.
0805	3.30	0.130	0.70	0.028	1.60	0.063	1.30	0.051
1206	4.50	0.177	1.50	0.059	2.00	0.079	1.50	0.059
1210	4.50	0.177	1.50	0.059	2.90	0.114	1.50	0.059
1808	5.90	0.232	2.30	0.091	2.40	0.094	1.80	0.071
1812	5.90	0.232	2.30	0.091	3.70	0.146	1.80	0.071
1825	5.90	0.232	2.30	0.091	6.90	0.272	1.80	0.071
2220	7.00	0.276	3.30	0.130	5.50	0.217	1.85	0.073
2225	7.00	0.276	3.30	0.130	6.80	0.268	1.85	0.073

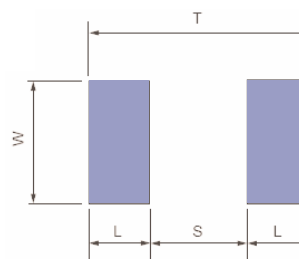

FEATURES

- Four individual capacitors inside one 1206 monolithic structure
- Saves board and inventory space
- One placement instead of four - less costly
- Easier to handle and solder than 4 smaller chips
- Tape and reel per EIA 481-1
- RoHS Compliant

CAPACITOR OUTLINE DRAWING

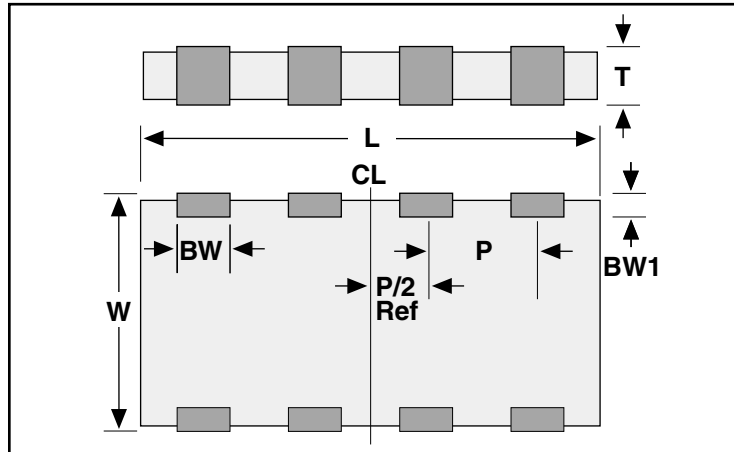

TABLE 1
EIA DIMENSIONS – MILLIMETERS (INCHES)

Size Code	Length L	Width W	Thickness T (max.)	Bandwidth BW	Bandwidth BW1	Pitch P
1632	3.2 (0.126) ± 0.2 (0.008)	1.6 (.063) ± 0.2 (.008)	0.7 - 1.35 (0.027 - 0.053)	0.40 (0.016) ± 0.2 (0.008)	0.1 - 0.5 (0.004 - 0.020)	0.8 (0.031) ± 0.1 (0.004)

Notes:

1. Metric is controlling - English for reference only.
2. Pitch (P) tolerances are non-cumulative along the package.
3. Thickness (T) depends on capacitance.

CERAMIC ARRAY ORDERING INFORMATION

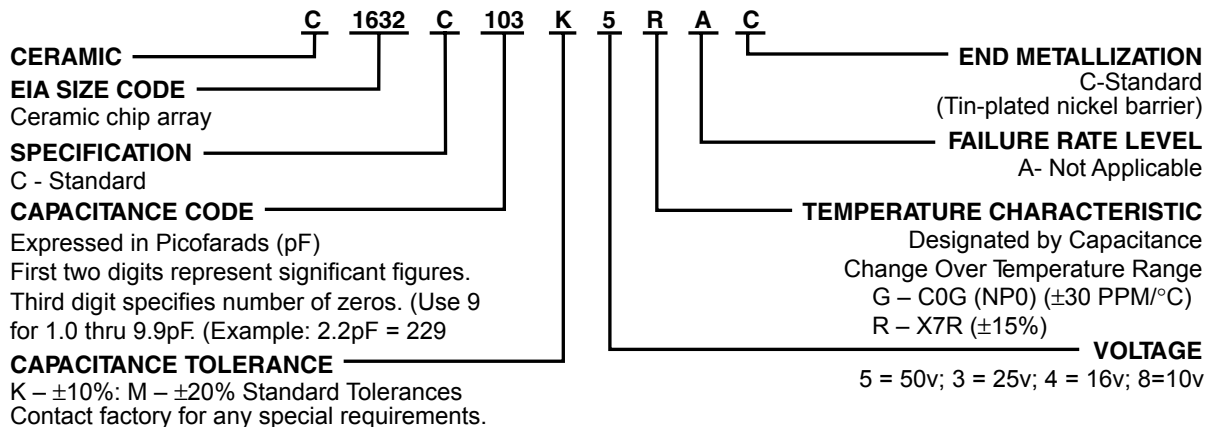

Ceramic Surface Mount

**TABLE 2A
COG DIELECTRIC – CAPACITANCE RANGE**

Capacitance Values (pF)	KEMET Part Number	Capacitance Tolerance	10V 16V	25V	50V	100V	200V
10	C1632C100(1)(2)GAC	K,M	100	100	100	100	100
12	C1632C120(1)(2)GAC	K,M	120	120	120	120	120
15	C1632C150(1)(2)GAC	K,M	150	150	150	150	150
18	C1632C180(1)(2)GAC	K,M	180	180	180	180	180
22	C1632C220(1)(2)GAC	K,M	220	220	220	220	220
27	C1632C270(1)(2)GAC	K,M	270	270	270	270	270
33	C1632C330(1)(2)GAC	K,M	330	330	330	330	330
39	C1632C390(1)(2)GAC	K,M	390	390	390	390	390
47	C1632C470(1)(2)GAC	K,M	470	470	470	470	470
56	C1632C560(1)(2)GAC	K,M	560	560	560	560	560
68	C1632C680(1)(2)GAC	K,M	680	680	680	680	680
82	C1632C820(1)(2)GAC	K,M	820	820	820	820	820
100	C1632C101(1)(2)GAC	K,M	101	101	101	101	101
120	C1632C121(1)(2)GAC	K,M	121	121	121	121	121
150	C1632C151(1)(2)GAC	K,M	151	151	151	151	151
180	C1632C181(1)(2)GAC	K,M	181	181	181	181	181
220	C1632C221(1)(2)GAC	K,M	221	221	221	221	221
270	C1632C271(1)(2)GAC	K,M	271	271	271	271	271
330	C1632C331(1)(2)GAC	K,M	331	331	331	331	331
390	C1632C391(1)(2)GAC	K,M	391	391	391	391	391
470	C1632C471(1)(2)GAC	K,M	471	471	471	471	471

(1) To complete the KEMET part number, insert the alpha code for the tolerance desired.
K = ±10% and M = ±20% – standard tolerance. Contact factory for any special requirements.
(2) To complete the KEMET part number, insert appropriate number for voltage desired:
"5" = 50 volts, "3" = 25 volts, "4" = 16 volts, and "8" = 10 volts.

**TABLE 2B
X7R DIELECTRIC – CAPACITANCE RANGE**

Capacitance Values (pF)	KEMET Part Number	Capacitance Tolerance	10V 16V	25V	50V	100V	200V
330	C1632C331(1)(2)RAC	K,M	331	331	331	331	331
390	C1632C391(1)(2)RAC	K,M	391	391	391	391	391
470	C1632C471(1)(2)RAC	K,M	471	471	471	471	471
560	C1632C561(1)(2)RAC	K,M	561	561	561	561	561
680	C1632C681(1)(2)RAC	K,M	681	681	681	681	681
820	C1632C821(1)(2)RAC	K,M	821	821	821	821	821
1000	C1632C102(1)(2)RAC	K,M	102	102	102	102	102
1200	C1632C122(1)(2)RAC	K,M	122	122	122	122	122
1500	C1632C152(1)(2)RAC	K,M	152	152	152	152	152
1800	C1632C182(1)(2)RAC	K,M	182	182	182	182	182
2200	C1632C222(1)(2)RAC	K,M	222	222	222	222	222
2700	C1632C272(1)(2)RAC	K,M	272	272	272	272	272
3300	C1632C332(1)(2)RAC	K,M	332	332	332	332	332
3900	C1632C392(1)(2)RAC	K,M	392	392	392	392	392
4700	C1632C472(1)(2)RAC	K,M	472	472	472	472	472
5600	C1632C562(1)(2)RAC	K,M	562	562	562	562	562
6800	C1632C682(1)(2)RAC	K,M	682	682	682	682	682
8200	C1632C822(1)(2)RAC	K,M	822	822	822	822	822
10,000	C1632C103(1)(2)RAC	K,M	103	103	103	103	103
12,000	C1632C123(1)(2)RAC	K,M	123	123	123	123	123
15,000	C1632C153(1)(2)RAC	K,M	153	153	153	153	153
18,000	C1632C183(1)(2)RAC	K,M	183	183	183	183	183
22,000	C1632C223(1)(2)RAC	K,M	223	223	223	223	223
27,000	C1632C273(1)(2)RAC	K,M	273	273	273	273	273
33,000	C1632C333(1)(2)RAC	K,M	333	333	333	333	333
39,000	C1632C393(1)(2)RAC	K,M	393	393	393	393	393
47,000	C1632C473(1)(2)RAC	K,M	473	473	473	473	473
56,000	C1632C563(1)(2)RAC	K,M	563	563	563	563	563
68,000	C1632C683(1)(2)RAC	K,M	683	683	683	683	683
82,000	C1632C823(1)(2)RAC	K,M	823	823	823	823	823
100,000	C1632C104(1)(2)RAC	K,M	104	104	104	104	104

(1) To complete the KEMET part number, insert the alpha code for the tolerance desired.
K = ±10% and M = ±20% – standard tolerances. Contact factory for any special requirements.
(2) To complete the KEMET part number, insert appropriate number for voltage desired:
"5" = 50 volts, "3" = 25 volts, "4" = 16 volts, and "8" = 10 volts.

**1632 CERAMIC ARRAY
LAND PATTERN LAYOUT**

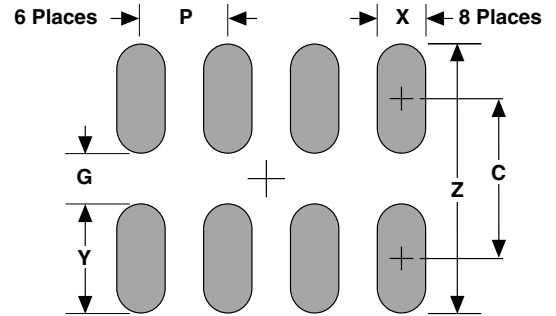

Additional pad dimension information is available in KEMET Technical Bulletin F-2100.

LAND PATTERN DIMENSIONS - CERAMIC CHIP CAPACITOR ARRAYS - MM

Dimension	Reflow Solder					
	Z	G	X	Y(ref)	C(ref)	P(ref)
3216	2.80	0.40	0.52	1.20	1.60	0.80

Calculation Formula
 $Z = L_{min} + 2J_t + T_t$
 $G = S_{max} - 2J_h - T_h$
 $X = W_{min} + 2J_s + T_s$
 $T_t, T_h, T_s =$ Combined tolerances

CAPACITOR OUTLINE DRAWINGS

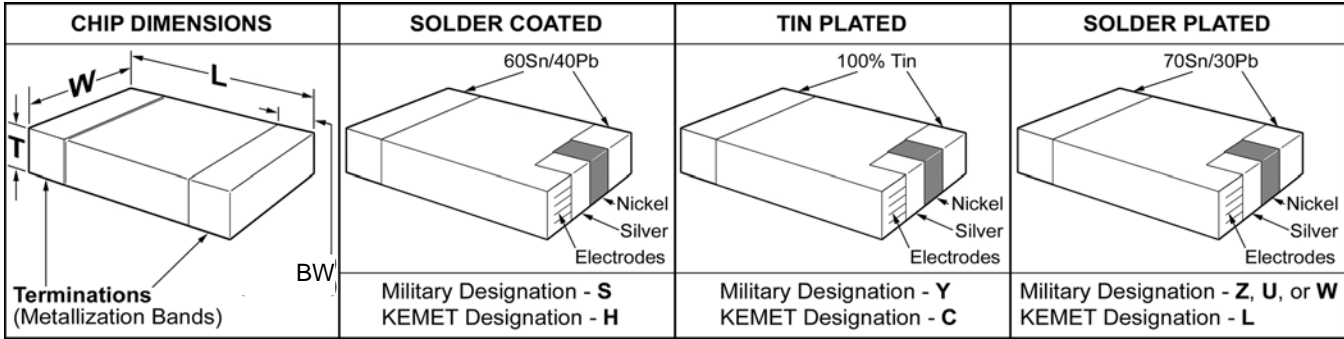

DIMENSIONS—MILLIMETERS AND (INCHES)

STYLE	KEMET SIZE CODE	L	W	T		BW
				MIN.	MAX.	
CDR01	C0805	2.03 ±.38 (.080 ±.015)	1.27 ±.38 (.050 ±.015)	.56 (.022)	1.40 (.055)	.51 ± 0.25 (.020 ±.010)
CDR02	C1805	4.57 ±.38 (.180 ±.015)	1.27 ±.38 (.050 ±.015)	.56 (.022)	1.40 (.055)	.51 ± 0.25 (.020 ±.010)
CDR03	C1808	4.57 ±.38 (.180 ±.015)	2.03 ±.38 (.080 ±.015)	.56 (.022)	2.03 (.080)	.51 ± 0.25 (.020 ±.010)
CDR04	C1812	4.57 ±.38 (.180 ±.015)	3.18 ±.38 (.125 ±.015)	.56 (.022)	2.03 (.080)	.51 ± 0.25 (.020 ±.010)
CDR05	C1825	4.57 $\begin{pmatrix} +.020 \\ .180 \\ -.38 \end{pmatrix}$	6.35 $\begin{pmatrix} +.020 \\ .250 \\ -.38 \end{pmatrix}$.51 (.020)	2.03 (.080)	.51 ± 0.25 (.020 ±.010)
CDR06	C2225	5.72 ±.51 (.225 ±.020)	6.35 ±.51 (.250 ±.020)	.51 (.020)	2.03 (.080)	.51 ± 0.25 (.020 ±.010)
CDR31	C0805	2.00 ±.20 (.078 ±.008)	1.25 ±.20 (.049 ±.008)		1.30 (.051)	.50 ± 0.20 (.020 ±.008)
CDR32	C1206	3.20 ±.20 (.125 ±.008)	1.60 ±.20 (.062 ±.008)		1.30 (.051)	.50 ± 0.20 (.020 ±.008)
CDR33	C1210	3.20 ±.25 (.125 ±.010)	2.50 ±.25 (.098 ±.010)		1.50 (.059)	.50 ± 0.25 (.020 ±.010)
CDR34	C1812	4.50 ±.25 (.176 ±.010)	3.20 ±.25 (.125 ±.010)		1.50 (.059)	.50 ± 0.25 (.020 ±.010)
CDR35	C1825	4.50 ±.30 (.176 ±.012)	6.40 ±.30 (.250 ±.012)		1.50 (.059)	.50 ± 0.30 (.020 ±.012)

Note: For MIL-C55681 "S" Endmet, the length, width and thickness positive tolerances (including bandwidth) cited above are allowed to increase by the following amounts:

	Length	Width
CDR01	0.51MM (.020)	0.38MM (.015)
CDR02-06	0.64MM (.025)	0.38MM (.015)
CDR31-35	0.60MM (.023)	0.30MM (.012)

MIL-PRF-55681 PART NUMBER ORDERING INFORMATION

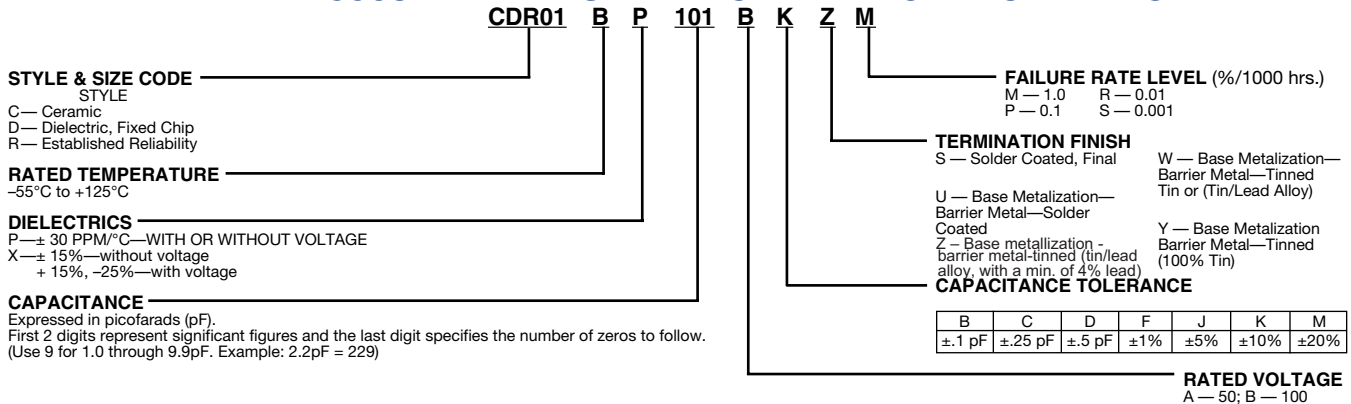

KEMET/MIL-PRF-55681 PART NUMBER EQUIVALENTS

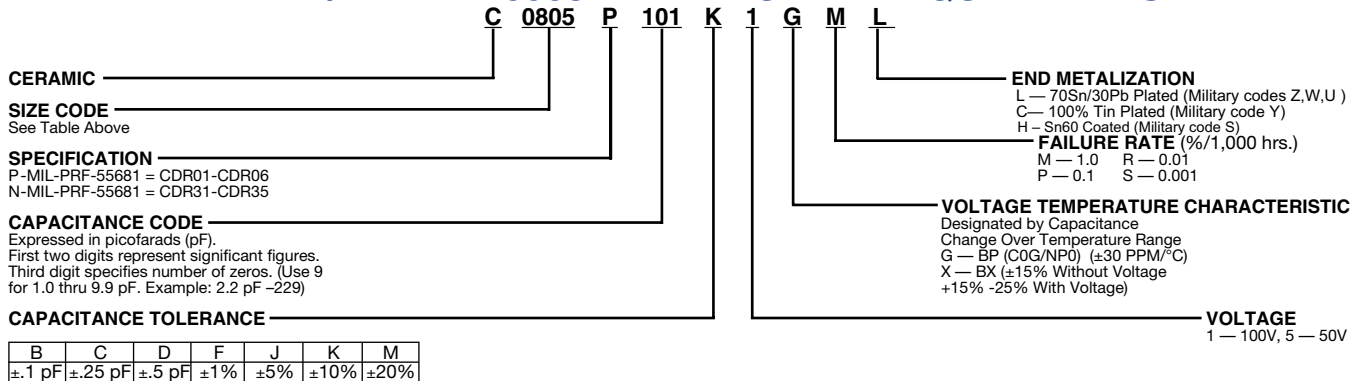

Ceramic Surface Mount

Part Number Example: C0805P101K1GML (14 digits - no spaces)

RATINGS & PART NUMBER REFERENCE

Characteristics	Cap pF	Avail. Tol.	KEMET Part Number	MIL-PRF-55681 Part Number
100 Volt - C0805 Size (Military CDR01)				
BP	10	J,K	C0805P100(3)1G(4)L	CDR01BP100B(3)Z(4)
	12	J	C0805P120J1G(4)L	CDR01BP120BJZ(4)
	15	J,K	C0805P150(3)1G(4)L	CDR01BP150B(3)Z(4)
	18	J	C0805P180J1G(4)L	CDR01BP180BJZ(4)
	22	J,K	C0805P220(3)1G(4)L	CDR01BP220B(3)Z(4)
	27	J	C0805P270J1G(4)L	CDR01BP270BJZ(4)
	33	J,K	C0805P330(3)1G(4)L	CDR01BP330B(3)Z(4)
	39	J	C0805P390J1G(4)L	CDR01BP390BJZ(4)
	47	J,K	C0805P470(3)1G(4)L	CDR01BP470B(3)Z(4)
	56	J	C0805P560J1G(4)L	CDR01BP560BJZ(4)
	68	J,K	C0805P680(3)1G(4)L	CDR01BP680B(3)Z(4)
	82	J	C0805P820J1G(4)L	CDR01BP820BJZ(4)
	100	J,K	C0805P101(3)1G(4)L	CDR01BP101B(3)Z(4)
	BP or BX	120	J,K	C0805P121(3)1(2)(4)L
150		J,K	C0805P151(3)1(2)(4)L	CDR01B(1)151B(3)Z(4)
180		J,K	C0805P181(3)1(2)(4)L	CDR01B(1)181B(3)Z(4)
BX	220	K,M	C0805P221(3)1X(4)L	CDR01BX221B(3)Z(4)
	270	K	C0805P271K1X(4)L	CDR01BX271BKZ(4)
	330	K,M	C0805P331(3)1X(4)L	CDR01BX331B(3)Z(4)
	390	K	C0805P391K1X(4)L	CDR01BX391BKZ(4)
	470	K,M	C0805P471(3)1X(4)L	CDR01BX471B(3)Z(4)
	560	K	C0805P561K1X(4)L	CDR01BX561BKZ(4)
	680	K,M	C0805P681(3)1X(4)L	CDR01BX681B(3)Z(4)
	820	K	C0805P821K1X(4)L	CDR01BX821BKZ(4)
	1,000	K,M	C0805P102(3)1X(4)L	CDR01BX102B(3)Z(4)
	1,200	K	C0805P122K1X(4)L	CDR01BX122BKZ(4)
	1,500	K,M	C0805P152(3)1X(4)L	CDR01BX152B(3)Z(4)
	1,800	K	C0805P182K1X(4)L	CDR01BX182BKZ(4)
	2,200	K,M	C0805P222(3)1X(4)L	CDR01BX222B(3)Z(4)
	2,700	K	C0805P272K1X(4)L	CDR01BX272BKZ(4)
3,300	K,M	C0805P332(3)1X(4)L	CDR01BX332B(3)Z(4)	
BX	3,900	K	C0805P392K5X(4)L	CDR01BX392AKZ(4)
	4,700	K,M	C0805P472(3)5X(4)L	CDR01BX472A(3)Z(4)
100 Volt - C1805 Size (Military CDR02)				
BP	220	J,K	C1805P221(3)1G(4)L	CDR02BP221B(3)Z(4)
	270	J	C1805P271J1G(4)L	CDR02BP271BJZ(4)
BX	3,900	K	C1805P392K1X(4)L	CDR02BX392BKZ(4)
	4,700	K,M	C1805P472(3)1X(4)L	CDR02BX472B(3)Z(4)
	5,600	K	C1805P562K1X(4)L	CDR02BX562BKZ(4)
	6,800	K,M	C1805P682(3)1X(4)L	CDR02BX682B(3)Z(4)
	8,200	K	C1805P822K1X(4)L	CDR02BX822BKZ(4)
	10,000	K,M	C1805P103(3)1X(4)L	CDR02BX103B(3)Z(4)
50 Volt - C1805 Size (Military CDR02)				
BX	12,000	K	C1805P123K5X(4)L	CDR02BX123AKZ(4)
	15,000	K,M	C1805P153(3)5X(4)L	CDR02BX153A(3)Z(4)
	18,000	K	C1805P183K5X(4)L	CDR02BX183AKZ(4)
	22,000	K,M	C1805P223(3)5X(4)L	CDR02BX223A(3)Z(4)
100 Volt - C1808 Size (Military CDR03)				
BP	330	J,K	C1808P331(3)1G(4)L	CDR03BP331B(3)Z(4)
	390	J	C1808P391J1G(4)L	CDR03BP391BJZ(4)
	470	J,K	C1808P471(3)1G(4)L	CDR03BP471B(3)Z(4)

Characteristics	Cap pF	Avail. Tol.	KEMET Part Number	MIL-PRF-55681 Part Number
100 Volt - C1808 Size (Military CDR03) cont.				
BP	560	J	C1808P561J1G(4)L	CDR03BP561BJZ(4)
	680	J,K	C1808P681(3)1G(4)L	CDR03BP681B(3)Z(4)
	820	J	C1808P821J1G(4)L	CDR03BP821BJZ(4)
	1,000	J,K	C1808P102(3)1G(4)L	CDR03BP102B(3)Z(4)
BX	12,000	K	C1808P123K1X(4)L	CDR03BX123BKZ(4)
	15,000	K,M	C1808P153(3)1X(4)L	CDR03BX153B(3)Z(4)
	18,000	K	C1808P183K1X(4)L	CDR03BX183BKZ(4)
	22,000	K,M	C1808P223(3)1X(4)L	CDR03BX223B(3)Z(4)
	27,000	K	C1808P273K1X(4)L	CDR03BX273BKZ(4)
	33,000	K,M	C1808P333(3)1X(4)L	CDR03BX333B(3)Z(4)
50 Volt - C1808 Size (Military CDR03)				
BX	39,000	K	C1808P393K5X(4)L	CDR03BX393AKZ(4)
	47,000	K,M	C1808P473(3)5X(4)L	CDR03BX473A(3)Z(4)
	56,000	K	C1808P563K5X(4)L	CDR03BX563AKZ(4)
	68,000	K,M	C1808P683(3)5X(4)L	CDR03BX683A(3)Z(4)
100 Volt - C1812 Size (Military CDR04)				
BP	1,200	J	C1812P122J1G(4)L	CDR04BP122BJZ(4)
	1,500	J,K	C1812P152(3)1G(4)L	CDR04BP152B(3)Z(4)
	1,800	J	C1812P182J1G(4)L	CDR04BP182BJZ(4)
	2,200	J,K	C1812P222(3)1G(4)L	CDR04BP222B(3)Z(4)
	2,700	J	C1812P272J1G(4)L	CDR04BP272BJZ(4)
	3,300	J,K	C1812P332(3)1G(4)L	CDR04BP332B(3)Z(4)
BX	39,000	K	C1812P393K1X(4)L	CDR04BX393BKZ(4)
	47,000	K,M	C1812P473(3)1X(4)L	CDR04BX473B(3)Z(4)
	56,000	K	C1812P563K1X(4)L	CDR04BX563BKZ(4)
50 Volt - C1812 Size (Military CDR04)				
BX	82,000	K	C1812P823K5X(4)L	CDR04BX823AKZ(4)
	100,000	K,M	C1812P104(3)5X(4)L	CDR04BX104A(3)Z(4)
	120,000	K	C1812P124K5X(4)L	CDR04BX124AKZ(4)
	150,000	K,M	C1812P154(3)5X(4)L	CDR04BX154A(3)Z(4)
	180,000	K	C1812P184K5X(4)L	CDR04BX184AKZ(4)
	100 Volt - C1825 Size (Military CDR05)			
BP	3,900	J,K	C1825P392(3)1G(4)L	CDR05BP392B(3)Z(4)
	4,700	J,K	C1825P472(3)1G(4)L	CDR05BP472B(3)Z(4)
	5,600	J,K	C1825P562(3)1G(4)L	CDR05BP562B(3)Z(4)
BX	68,000	K,M	C1825P683(3)1X(4)L	CDR05BX683B(3)Z(4)
	82,000	K	C1825P823K1X(4)L	CDR05BX823BKZ(4)
	100,000	K,M	C1825P104(3)1X(4)L	CDR05BX104B(3)Z(4)
	120,000	K	C1825P124K1X(4)L	CDR05BX124BKZ(4)
	150,000	K,M	C1825P154(3)1X(4)L	CDR05BX154B(3)Z(4)
50 Volt - C1825 Size (Military CDR05)				
BX	220,000	K,M	C1825P224(3)5X(4)L	CDR05BX224A(3)Z(4)
	270,000	K	C1825P274K5X(4)L	CDR05BX274AKZ(4)
	330,000	K,M	C1825P334(3)5X(4)L	CDR05BX334A(3)Z(4)
100 Volt - C2225 Size (Military CDR06)				
BP	6,800	J,K	C2225P682(3)1G(4)L	CDR06BP682B(3)Z(4)
	8,200	J,K	C2225P822(3)1G(4)L	CDR06BP822B(3)Z(4)
	10,000	J,K	C2225P103(3)1G(4)L	CDR06BP103B(3)Z(4)
50 Volt - C2225 Size (Military CDR06)				
BX	390,000	K	C2225P394K5X(4)L	CDR06BX394AKZ(4)
	470,000	K,M	C2225P474(3)5X(4)L	CDR06BX474A(3)Z(4)

- (1) To complete Part Number for Dielectric, insert P or X symbol – as defined by Military specification.
- (2) To complete Part Number for Dielectric, insert G or X symbol. ("G" for Military "BP," or "X" for Military "BX.")
- (3) To complete Part Number, insert Capacitance Tolerance Symbol (when applicable) as available in MIL-PRF-55681: B – ±0.1 pF, C – ±0.25 pF, D – ±0.5pF, F – ±1%, J – ±5%, K – ±10%, M – ±20%. **NOTE: Available tolerances are listed in columns above.**
- (4) To complete Part Number, insert Failure Rate Symbol: M – 1.0%; P – 0.1%; R – 0.01%; S – .001%.

Note: All MIL-PRF-55681 and KEMET Part Numbers tabulated above assume use of (MIL-PRF-55681 "Z"; KEMET "L") end metalization. If MIL-PRF-55681 "U" or "W" (KEMET "L") or MIL-PRF-55681 "S" (KEMET "H"), OR MIL-PRF-55681 "Y" (KEMET "C") is required, please change designators accordingly.

RATINGS & PART NUMBER REFERENCE

Cap pF	Avail. Tol.	KEMET Part Number	MIL-PRF-55681 Part Number
100 Volt - BP - C0805 Size (Military CDR31)			
1.0	B,C	C0805N109(3)1G(4)L	CDR31BP1R0B(3)Z(4)
1.1	B,C	C0805N119(3)1G(4)L	CDR31BP1R1B(3)Z(4)
1.2	B,C	C0805C129(3)1G(4)L	CDR31BP1R2B(3)Z(4)
1.3	B,C	C0805N139(3)1G(4)L	CDR31BP1R3B(3)Z(4)
1.5	B,C	C0805N159(3)1G(4)L	CDR31BP1R5B(3)Z(4)
1.6	B,C	C0805N169(3)1G(4)L	CDR31BP1R6B(3)Z(4)
1.8	B,C	C0805N189(3)1G(4)L	CDR31BP1R8B(3)Z(4)
2.0	B,C	C0805N209(3)1G(4)L	CDR31BP2R0B(3)Z(4)
2.2	B,C	C0805N229(3)1G(4)L	CDR31BP2R2B(3)Z(4)
2.4	B,C	C0805N249(3)1G(4)L	CDR31BP2R4B(3)Z(4)
2.7	B,C,D	C0805N279(3)1G(4)L	CDR31BP2R7B(3)Z(4)
3.0	B,C,D	C0805N309(3)1G(4)L	CDR31BP3R0B(3)Z(4)
3.3	B,C,D	C0805N339(3)1G(4)L	CDR31BP3R3B(3)Z(4)
3.6	B,C,D	C0805N369(3)1G(4)L	CDR31BP3R6B(3)Z(4)
3.9	B,C,D	C0805N399(3)1G(4)L	CDR31BP3R9B(3)Z(4)
4.3	B,C,D	C0805N439(3)1G(4)L	CDR31BP4R3B(3)Z(4)
4.7	B,C,D	C0805N479(3)1G(4)L	CDR31BP4R7B(3)Z(4)
5.1	B,C,D	C0805N519(3)1G(4)L	CDR31BP5R1B(3)Z(4)
5.6	B,C,D	C0805N569(3)1G(4)L	CDR31BP5R6B(3)Z(4)
6.2	B,C,D	C0805N629(3)1G(4)L	CDR31BP6R2B(3)Z(4)
6.8	B,C,D	C0805N689(3)1G(4)L	CDR31BP6R8B(3)Z(4)
7.5	B,C,D	C0805N759(3)1G(4)L	CDR31BP7R5B(3)Z(4)
8.2	B,C,D	C0805N829(3)1G(4)L	CDR31BP8R2B(3)Z(4)
9.1	B,C,D	C0805N919(3)1G(4)L	CDR31BP9R1B(3)Z(4)
10	F,J,K	C0805N100(3)1G(4)L	CDR31BP100B(3)Z(4)
11	F,J,K	C0805N110(3)1G(4)L	CDR31BP110B(3)Z(4)
12	F,J,K	C0805N120(3)1G(4)L	CDR31BP120B(3)Z(4)
13	F,J,K	C0805N130(3)1G(4)L	CDR31BP130B(3)Z(4)
15	F,J,K	C0805N150(3)1G(4)L	CDR31BP150B(3)Z(4)
16	F,J,K	C0805N160(3)1G(4)L	CDR31BP160B(3)Z(4)
18	F,J,K	C0805N180(3)1G(4)L	CDR31BP180B(3)Z(4)
20	F,J,K	C0805N200(3)1G(4)L	CDR31BP200B(3)Z(4)
22	F,J,K	C0805N220(3)1G(4)L	CDR31BP220B(3)Z(4)
24	F,J,K	C0805N240(3)1G(4)L	CDR31BP240B(3)Z(4)
27	F,J,K	C0805N270(3)1G(4)L	CDR31BP270B(3)Z(4)
30	F,J,K	C0805N300(3)1G(4)L	CDR31BP300B(3)Z(4)
33	F,J,K	C0805N330(3)1G(4)L	CDR31BP330B(3)Z(4)
36	F,J,K	C0805N360(3)1G(4)L	CDR31BP360B(3)Z(4)
39	F,J,K	C0805N390(3)1G(4)L	CDR31BP390B(3)Z(4)
43	F,J,K	C0805N430(3)1G(4)L	CDR31BP430B(3)Z(4)
47	F,J,K	C0805N470(3)1G(4)L	CDR31BP470B(3)Z(4)
51	F,J,K	C0805N510(3)1G(4)L	CDR31BP510B(3)Z(4)
56	F,J,K	C0805N560(3)1G(4)L	CDR31BP560B(3)Z(4)
62	F,J,K	C0805N620(3)1G(4)L	CDR31BP620B(3)Z(4)
68	F,J,K	C0805N680(3)1G(4)L	CDR31BP680B(3)Z(4)
75	F,J,K	C0805N750(3)1G(4)L	CDR31BP750B(3)Z(4)
82	F,J,K	C0805N820(3)1G(4)L	CDR31BP820B(3)Z(4)

Cap pF	Avail. Tol.	KEMET Part Number	MIL-PRF-55681 Part Number
100 Volt - BP - C0805 Size (Military CDR31)			
91	F,J,K	C0805N910(3)1G(4)L	CDR31BP910B(3)Z(4)
100	F,J,K	C0805N101(3)1G(4)L	CDR31BP101B(3)Z(4)
110	F,J,K	C0805N111(3)1G(4)L	CDR31BP111B(3)Z(4)
120	F,J,K	C0805N121(3)1G(4)L	CDR31BP121B(3)Z(4)
130	F,J,K	C0805N131(3)1G(4)L	CDR31BP131B(3)Z(4)
150	F,J,K	C0805N151(3)1G(4)L	CDR31BP151B(3)Z(4)
160	F,J,K	C0805N161(3)1G(4)L	CDR31BP161B(3)Z(4)
180	F,J,K	C0805N181(3)1G(4)L	CDR31BP181B(3)Z(4)
200	F,J,K	C0805N201(3)1G(4)L	CDR31BP201B(3)Z(4)
220	F,J,K	C0805N221(3)1G(4)L	CDR31BP221B(3)Z(4)
240	F,J,K	C0805N241(3)1G(4)L	CDR31BP241B(3)Z(4)
270	F,J,K	C0805N271(3)1G(4)L	CDR31BP271B(3)Z(4)
300	F,J,K	C0805N301(3)1G(4)L	CDR31BP301B(3)Z(4)
330	F,J,K	C0805N331(3)1G(4)L	CDR31BP331B(3)Z(4)
360	F,J,K	C0805N361(3)1G(4)L	CDR31BP361B(3)Z(4)
390	F,J,K	C0805N391(3)1G(4)L	CDR31BP391B(3)Z(4)
430	F,J,K	C0805N431(3)1G(4)L	CDR31BP431B(3)Z(4)
470	F,J,K	C0805N471(3)1G(4)L	CDR31BP471B(3)Z(4)
50 Volt - BP - C0805 Size (Military CDR31)			
510	F,J,K	C0805N511(3)5G(4)L	CDR31BP511A(3)Z(4)
560	F,J,K	C0805N561(3)5G(4)L	CDR31BP561A(3)Z(4)
620	F,J,K	C0805N621(3)5G(4)L	CDR31BP621A(3)Z(4)
680	F,J,K	C0805N681(3)5G(4)L	CDR31BP681A(3)Z(4)
100 Volt - BX - C0805 Size (Military CDR31)			
470	K,M	C0805N471(3)1X(4)L	CDR31BX471B(3)Z(4)
560	K,M	C0805N561(3)1X(4)L	CDR31BX561B(3)Z(4)
680	K,M	C0805N681(3)1X(4)L	CDR31BX681B(3)Z(4)
820	K,M	C0805N821(3)1X(4)L	CDR31BX821B(3)Z(4)
1,000	K,M	C0805N102(3)1X(4)L	CDR31BX102B(3)Z(4)
1,200	K,M	C0805N122(3)1X(4)L	CDR31BX122B(3)Z(4)
1,500	K,M	C0805N152(3)1X(4)L	CDR31BX152B(3)Z(4)
1,800	K,M	C0805N182(3)1X(4)L	CDR31BX182B(3)Z(4)
2,200	K,M	C0805N222(3)1X(4)L	CDR31BX222B(3)Z(4)
2,700	K,M	C0805N272(3)1X(4)L	CDR31BX272B(3)Z(4)
3,300	K,M	C0805N332(3)1X(4)L	CDR31BX332B(3)Z(4)
3,900	K,M	C0805N392(3)1X(4)L	CDR31BX392B(3)Z(4)
4,700	K,M	C0805N472(3)1X(4)L	CDR31BX472B(3)Z(4)
50 Volt - BX - C0805 Size (Military CDR31)			
5,600	K,M	C0805N562(3)5X(4)L	CDR31BX562A(3)Z(4)
6,800	K,M	C0805N682(3)5X(4)L	CDR31BX682A(3)Z(4)
8,200	K,M	C0805N822(3)5X(4)L	CDR31BX822A(3)Z(4)
10,000	K,M	C0805N103(3)5X(4)L	CDR31BX103A(3)Z(4)
12,000	K,M	C0805N123(3)5X(4)L	CDR31BX123A(3)Z(4)
15,000	K,M	C0805N153(3)5X(4)L	CDR31BX153A(3)Z(4)
18,000	K,M	C0805N183(3)5X(4)L	CDR31BX183A(3)Z(4)

Ceramic Surface Mount

- (1) To complete Part Number for Dielectric, insert P or X symbol – as defined by Military specification.
- (2) To complete Part Number for Dielectric, insert G or X symbol. ("G" for Military "BP," or "X" for Military "BX.")
- (3) To complete Part Number, insert Capacitance Tolerance Symbol (when applicable) as available in MIL-PRF-55681: B – ±0.1 pF, C – ±0.25 pF. D – ±0.5pF, F – ±1%, J – ±5%, K – ±10%, M – ±20%. **NOTE: Available tolerances are listed in columns above.**
- (4) To complete Part Number, insert Failure Rate Symbol: M –1.0%; P –0.1%; R –0.01%; S –.001%.

Note: All MIL-PRF-55681 and KEMET Part Numbers tabulated above assume use of MIL-PRF-55681 "Z"; KEMET "L" end metalization. If MIL-PRF-55681 "U" or "W" (KEMET "L") or MIL-PRF-55681 "S" (KEMET "H"), or MIL-PRF-55681 "Y" (KEMET "C") is required, change designators accordingly.

MARKING

See page 97 for MIL-PRF-55681 Marking

RATINGS & PART NUMBER REFERENCE

Cap pF	Avail. Tol.	KEMET Part Number	MIL-PRF-55681 Part Number
100 Volt - BP - C1206 Size (Military CDR32)			
1.0	B,C	C1206N109(3)1G(4)L	CDR32BP1R0B(3)Z(4)
1.1	B,C	C1206N119(3)1G(4)L	CDR32BP1R1B(3)Z(4)
1.2	B,C	C1206C129(3)1G(4)L	CDR32BP1R2B(3)Z(4)
1.3	B,C	C1206N139(3)1G(4)L	CDR32BP1R3B(3)Z(4)
1.5	B,C	C1206N159(3)1G(4)L	CDR32BP1R5B(3)Z(4)
1.6	B,C	C1206N169(3)1G(4)L	CDR32BP1R6B(3)Z(4)
1.8	B,C	C1206N189(3)1G(4)L	CDR32BP1R8B(3)Z(4)
2.0	B,C	C1206N209(3)1G(4)L	CDR32BP2R0B(3)Z(4)
2.2	B,C	C1206N229(3)1G(4)L	CDR32BP2R2B(3)Z(4)
2.4	B,C	C1206N249(3)1G(4)L	CDR32BP2R4B(3)Z(4)
2.7	B,C,D	C1206N279(3)1G(4)L	CDR32BP2R7B(3)Z(4)
3.0	B,C,D	C1206N309(3)1G(4)L	CDR32BP3R0B(3)Z(4)
3.3	B,C,D	C1206N339(3)1G(4)L	CDR32BP3R3B(3)Z(4)
3.6	B,C,D	C1206N369(3)1G(4)L	CDR32BP3R6B(3)Z(4)
3.9	B,C,D	C1206N399(3)1G(4)L	CDR32BP3R9B(3)Z(4)
4.3	B,C,D	C1206N439(3)1G(4)L	CDR32BP4R3B(3)Z(4)
4.7	B,C,D	C1206N479(3)1G(4)L	CDR32BP4R7B(3)Z(4)
5.1	B,C,D	C1206N519(3)1G(4)L	CDR32BP5R1B(3)Z(4)
5.6	B,C,D	C1206N569(3)1G(4)L	CDR32BP5R6B(3)Z(4)
6.2	B,C,D	C1206N629(3)1G(4)L	CDR32BP6R2B(3)Z(4)
6.8	B,C,D	C1206N689(3)1G(4)L	CDR32BP6R8B(3)Z(4)
7.5	B,C,D	C1206N759(3)1G(4)L	CDR32BP7R5B(3)Z(4)
8.2	B,C,D	C1206N829(3)1G(4)L	CDR32BP8R2B(3)Z(4)
9.1	B,C,D	C1206N919(3)1G(4)L	CDR32BP9R1B(3)Z(4)
10	F,J,K	C1206N100(3)1G(4)L	CDR32BP100B(3)Z(4)
11	F,J,K	C1206N110(3)1G(4)L	CDR32BP110B(3)Z(4)
12	F,J,K	C1206N120(3)1G(4)L	CDR32BP120B(3)Z(4)
13	F,J,K	C1206N130(3)1G(4)L	CDR32BP130B(3)Z(4)
15	F,J,K	C1206N150(3)1G(4)L	CDR32BP150B(3)Z(4)
16	F,J,K	C1206N160(3)1G(4)L	CDR32BP160B(3)Z(4)
18	F,J,K	C1206N180(3)1G(4)L	CDR32BP180B(3)Z(4)
20	F,J,K	C1206N200(3)1G(4)L	CDR32BP200B(3)Z(4)
22	F,J,K	C1206N220(3)1G(4)L	CDR32BP220B(3)Z(4)
24	F,J,K	C1206N240(3)1G(4)L	CDR32BP240B(3)Z(4)
27	F,J,K	C1206N270(3)1G(4)L	CDR32BP270B(3)Z(4)
30	F,J,K	C1206N300(3)1G(4)L	CDR32BP300B(3)Z(4)
33	F,J,K	C1206N330(3)1G(4)L	CDR32BP330B(3)Z(4)
36	F,J,K	C1206N360(3)1G(4)L	CDR32BP360B(3)Z(4)
39	F,J,K	C1206N390(3)1G(4)L	CDR32BP390B(3)Z(4)
43	F,J,K	C1206N430(3)1G(4)L	CDR32BP430B(3)Z(4)
47	F,J,K	C1206N470(3)1G(4)L	CDR32BP470B(3)Z(4)
51	F,J,K	C1206N510(3)1G(4)L	CDR32BP510B(3)Z(4)
56	F,J,K	C1206N560(3)1G(4)L	CDR32BP560B(3)Z(4)
62	F,J,K	C1206N620(3)1G(4)L	CDR32BP620B(3)Z(4)
68	F,J,K	C1206N680(3)1G(4)L	CDR32BP680B(3)Z(4)
75	F,J,K	C1206N750(3)1G(4)L	CDR32BP750B(3)Z(4)
82	F,J,K	C1206N820(3)1G(4)L	CDR32BP820B(3)Z(4)
91	F,J,K	C1206N910(3)1G(4)L	CDR32BP910B(3)Z(4)
100	F,J,K	C1206N101(3)1G(4)L	CDR32BP101B(3)Z(4)

Cap pF	Avail. Tol.	KEMET Part Number	MIL-PRF-55681 Part Number
100 Volt - BP - C1206 Size (Military CDR32)			
110	F,J,K	C1206N111(3)1G(4)L	CDR32BP111B(3)Z(4)
120	F,J,K	C1206N121(3)1G(4)L	CDR32BP121B(3)Z(4)
130	F,J,K	C1206N131(3)1G(4)L	CDR32BP131B(3)Z(4)
150	F,J,K	C1206N151(3)1G(4)L	CDR32BP151B(3)Z(4)
160	F,J,K	C1206N161(3)1G(4)L	CDR32BP161B(3)Z(4)
180	F,J,K	C1206N181(3)1G(4)L	CDR32BP181B(3)Z(4)
200	F,J,K	C1206N201(3)1G(4)L	CDR32BP201B(3)Z(4)
220	F,J,K	C1206N221(3)1G(4)L	CDR32BP221B(3)Z(4)
240	F,J,K	C1206N241(3)1G(4)L	CDR32BP241B(3)Z(4)
270	F,J,K	C1206N271(3)1G(4)L	CDR32BP271B(3)Z(4)
300	F,J,K	C1206N301(3)1G(4)L	CDR32BP301B(3)Z(4)
330	F,J,K	C1206N331(3)1G(4)L	CDR32BP331B(3)Z(4)
360	F,J,K	C1206N361(3)1G(4)L	CDR32BP361B(3)Z(4)
390	F,J,K	C1206N391(3)1G(4)L	CDR32BP391B(3)Z(4)
430	F,J,K	C1206N431(3)1G(4)L	CDR32BP431B(3)Z(4)
470	F,J,K	C1206N471(3)1G(4)L	CDR32BP471B(3)Z(4)
510	F,J,K	C1206N511(3)1G(4)L	CDR32BP511B(3)Z(4)
560	F,J,K	C1206N561(3)1G(4)L	CDR32BP561B(3)Z(4)
620	F,J,K	C1206N621(3)1G(4)L	CDR32BP621B(3)Z(4)
680	F,J,K	C1206N681(3)1G(4)L	CDR32BP681B(3)Z(4)
750	F,J,K	C1206N751(3)1G(4)L	CDR32BP751B(3)Z(4)
820	F,J,K	C1206N821(3)1G(4)L	CDR32BP821B(3)Z(4)
910	F,J,K	C1206N911(3)1G(4)L	CDR32BP911B(3)Z(4)
1,000	F,J,K	C1206N102(3)1G(4)L	CDR32BP102B(3)Z(4)
50 Volt - BP - C1206 Size (Military CDR32)			
1,100	F,J,K	C1206N112(3)5G(4)L	CDR32BP112A(3)Z(4)
1,200	F,J,K	C1206N122(3)5G(4)L	CDR32BP122A(3)Z(4)
1,300	F,J,K	C1206N132(3)5G(4)L	CDR32BP132A(3)Z(4)
1,500	F,J,K	C1206N152(3)5G(4)L	CDR32BP152A(3)Z(4)
1,600	F,J,K	C1206N162(3)5G(4)L	CDR32BP162A(3)Z(4)
1,800	F,J,K	C1206N182(3)5G(4)L	CDR32BP182A(3)Z(4)
2,000	F,J,K	C1206N202(3)5G(4)L	CDR32BP202A(3)Z(4)
2,200	F,J,K	C1206N222(3)5G(4)L	CDR32BP222A(3)Z(4)
100 Volt - BX - C1206 Size (Military CDR32)			
4,700	K,M	C1206N472(3)1X(4)L	CDR32BX472B(3)Z(4)
5,600	K,M	C1206N562(3)1X(4)L	CDR32BX562B(3)Z(4)
6,800	K,M	C1206N682(3)1X(4)L	CDR32BX682B(3)Z(4)
8,200	K,M	C1206N822(3)1X(4)L	CDR32BX822B(3)Z(4)
10,000	K,M	C1206N103(3)1X(4)L	CDR32BX103B(3)Z(4)
12,000	K,M	C1206N123(3)1X(4)L	CDR32BX123B(3)Z(4)
15,000	K,M	C1206N153(3)1X(4)L	CDR32BX153B(3)Z(4)
50 Volt - BX - C1206 Size (Military CDR32)			
18,000	K,M	C1206N183(3)5X(4)L	CDR32BX183A(3)Z(4)
22,000	K,M	C1206N223(3)5X(4)L	CDR32BX223A(3)Z(4)
27,000	K,M	C1206N273(3)5X(4)L	CDR32BX273A(3)Z(4)
33,000	K,M	C1206N333(3)5X(4)L	CDR32BX333A(3)Z(4)
39,000	K,M	C1206N393(3)5X(4)L	CDR32BX393A(3)Z(4)

- (1) To complete Part Number for Dielectric, insert P or X symbol – as defined by Military specification.
- (2) To complete Part Number for Dielectric, insert G or X symbol. (“G” for Military “BP,” or “X” for Military “BX.”)
- (3) To complete Part Number, insert Capacitance Tolerance Symbol (when applicable) as available in MIL-PRF-55681: B – ±0.1 pF, C – ±0.25 pF, D – ±0.5pF, F – ±1%, J – ±5%, K – ±10%, M – ±20%. **NOTE: Available tolerances are listed in columns above.**
- (4) To complete Part Number, insert Failure Rate Symbol: M –1.0%; P –0.1%; R –0.01%; S –.001%.

Note: All MIL-PRF-55681 and KEMET Part Numbers tabulated above assume use of MIL-PRF-55681 “Z”; KEMET “L” end metalization. If MIL-PRF-55681 “U” or “W” (KEMET “L”) or MIL-PRF-55681 “S” (KEMET “H”), or MIL-PRF-55681 “Y” (KEMET “C”) is required, please change designators.

RATINGS & PART NUMBER REFERENCE

Cap pF	Avail. Tol.	KEMET Part Number	MIL-PRF-55681 Part Number
100 Volt - BP - C1210 Size (Military CDR33)			
1,000	F,J,K	C1210N102(3)1G(4)L	CDR33BP102B(3)Z(4)
1,100	F,J,K	C1210N112(3)1G(4)L	CDR33BP112B(3)Z(4)
1,200	F,J,K	C1210N122(3)1G(4)L	CDR33BP122B(3)Z(4)
1,300	F,J,K	C1210N132(3)1G(4)L	CDR33BP132B(3)Z(4)
1,500	F,J,K	C1210N152(3)1G(4)L	CDR33BP152B(3)Z(4)
1,600	F,J,K	C1210N162(3)1G(4)L	CDR33BP162B(3)Z(4)
1,800	F,J,K	C1210N182(3)1G(4)L	CDR33BP182B(3)Z(4)
2,000	F,J,K	C1210N202(3)1G(4)L	CDR33BP202B(3)Z(4)
2,200	F,J,K	C1210N222(3)1G(4)L	CDR33BP222B(3)Z(4)
50 Volt - BP - C1210 Size (Military CDR33)			
2,400	F,J,K	C1210N242(3)5G(4)L	CDR33BP242A(3)Z(4)
2,700	F,J,K	C1210N272(3)5G(4)L	CDR33BP272A(3)Z(4)
3,000	F,J,K	C1210N302(3)5G(4)L	CDR33BP302A(3)Z(4)
3,300	F,J,K	C1210N332(3)5G(4)L	CDR33BP332A(3)Z(4)
100 Volt - BX - C1210 Size (Military CDR33)			
15,000	K,M	C1210N153(3)1X(4)L	CDR33BX153B(3)Z(4)
18,000	K,M	C1210N183(3)1X(4)L	CDR33BX183B(3)Z(4)
22,000	K,M	C1210N223(3)1X(4)L	CDR33BX223B(3)Z(4)
27,000	K,M	C1210N273(3)1X(4)L	CDR33BX273B(3)Z(4)
50 Volt - BX - C1210 Size (Military CDR33)			
39,000	K,M	C1210N393(3)5X(4)L	CDR33BX393A(3)Z(4)
47,000	K,M	C1210N473(3)5X(4)L	CDR33BX473A(3)Z(4)
56,000	K,M	C1210N563(3)5X(4)L	CDR33BX563A(3)Z(4)
68,000	K,M	C1210N683(3)5X(4)L	CDR33BX683A(3)Z(4)
82,000	K,M	C1210N823(3)5X(4)L	CDR33BX823A(3)Z(4)
100,000	K,M	C1210N104(3)5X(4)L	CDR33BX104A(3)Z(4)
100 Volt - BP - C1812 Size (Military CDR34)			
2,200	F,J,K	C1812N222(3)1G(4)L	CDR34BP222B(3)Z(4)
2,400	F,J,K	C1812N242(3)1G(4)L	CDR34BP242B(3)Z(4)
2,700	F,J,K	C1812N272(3)1G(4)L	CDR34BP272B(3)Z(4)
3,000	F,J,K	C1812N322(3)1G(4)L	CDR34BP302B(3)Z(4)
3,300	F,J,K	C1812N332(3)1G(4)L	CDR34BP332B(3)Z(4)
3,600	F,J,K	C1812N362(3)1G(4)L	CDR34BP362B(3)Z(4)
3,900	F,J,K	C1812N392(3)1G(4)L	CDR34BP392B(3)Z(4)
4,300	F,J,K	C1812N432(3)1G(4)L	CDR34BP432B(3)Z(4)
4,700	F,J,K	C1812N472(3)1G(4)L	CDR34BP472B(3)Z(4)
50 Volt - BP - C1812 Size (Military CDR34)			
5,100	F,J,K	C1812N512(3)5G(4)L	CDR34BP512A(3)Z(4)
5,600	F,J,K	C1812N562(3)5G(4)L	CDR34BP562A(3)Z(4)
6,200	F,J,K	C1812N622(3)5G(4)L	CDR34BP622A(3)Z(4)
6,800	F,J,K	C1812N682(3)5G(4)L	CDR34BP682A(3)Z(4)
7,500	F,J,K	C1812N752(3)5G(4)L	CDR34BP752A(3)Z(4)
8,200	F,J,K	C1812N822(3)5G(4)L	CDR34BP822A(3)Z(4)
9,100	F,J,K	C1812N912(3)5G(4)L	CDR34BP912A(3)Z(4)
10,000	F,J,K	C1812N103(3)5G(4)L	CDR34BP103A(3)Z(4)

Cap pF	Avail. Tol.	KEMET Part Number	MIL-PRF-55681 Part Number
100 Volt - BX - C1812 Size (Military CDR34)			
27,000	K,M	C1812N273(3)1X(4)L	CDR34BX273B(3)Z(4)
33,000	K,M	C1812N333(3)1X(4)L	CDR34BX333B(3)Z(4)
39,000	K,M	C1812N393(3)1X(4)L	CDR34BX393B(3)Z(4)
47,000	K,M	C1812N473(3)1X(4)L	CDR34BX473B(3)Z(4)
56,000	K,M	C1812N563(3)1X(4)L	CDR34BX563B(3)Z(4)
50 Volt - BX - C1812 Size (Military CDR34)			
100,000	K,M	C1812N104(3)5X(4)L	CDR34BX104A(3)Z(4)
120,000	K,M	C1812N124(3)5X(4)L	CDR34BX124A(3)Z(4)
150,000	K,M	C1812N154(3)5X(4)L	CDR34BX154A(3)Z(4)
180,000	K,M	C1812N184(3)5X(4)L	CDR34BX184A(3)Z(4)
100 Volt - BP - C1825 Size (Military CDR35)			
4,700	F,J,K	C1825N472(3)1G(4)L	CDR35BP472B(3)Z(4)
5,100	F,J,K	C1825N512(3)1G(4)L	CDR35BP512B(3)Z(4)
5,600	F,J,K	C1825N562(3)1G(4)L	CDR35BP562B(3)Z(4)
6,200	F,J,K	C1825N622(3)1G(4)L	CDR35BP622B(3)Z(4)
6,800	F,J,K	C1825N682(3)1G(4)L	CDR35BP682B(3)Z(4)
7,500	F,J,K	C1825N752(3)1G(4)L	CDR35BP752B(3)Z(4)
8,200	F,J,K	C1825N822(3)1G(4)L	CDR35BP822B(3)Z(4)
9,100	F,J,K	C1825N912(3)1G(4)L	CDR35BP912B(3)Z(4)
10,000	F,J,K	C1825N103(3)1G(4)L	CDR35BP103B(3)Z(4)
50 Volt - BP - C1825 Size (Military CDR35)			
11,000	F,J,K	C1825N113(3)5G(4)L	CDR35BP113A(3)Z(4)
12,000	F,J,K	C1825N123(3)5G(4)L	CDR35BP123A(3)Z(4)
13,000	F,J,K	C1825N133(3)5G(4)L	CDR35BP133A(3)Z(4)
15,000	F,J,K	C1825N153(3)5G(4)L	CDR35BP153A(3)Z(4)
16,000	F,J,K	C1825N163(3)5G(4)L	CDR35BP163A(3)Z(4)
18,000	F,J,K	C1825N183(3)5G(4)L	CDR35BP183A(3)Z(4)
20,000	F,J,K	C1825N203(3)5G(4)L	CDR35BP203A(3)Z(4)
22,000	F,J,K	C1825N223(3)5G(4)L	CDR35BP223A(3)Z(4)
100 Volt - BX - C1825 Size (Military CDR35)			
56,000	K,M	C1825N563(3)1X(4)L	CDR35BX563B(3)Z(4)
68,000	K,M	C1825N683(3)1X(4)L	CDR35BX683B(3)Z(4)
82,000	K,M	C1825N823(3)1X(4)L	CDR35BX823B(3)Z(4)
100,000	K,M	C1825N104(3)1X(4)L	CDR35BX104B(3)Z(4)
120,000	K,M	C1825N124(3)1X(4)L	CDR35BX124B(3)Z(4)
150,000	K,M	C1825N154(3)1X(4)L	CDR35BX154B(3)Z(4)
50 Volt - BX - C1825 Size (Military CDR35)			
180,000	K,M	C1825N184(3)5X(4)L	CDR35BX184A(3)Z(4)
220,000	K,M	C1825N224(3)5X(4)L	CDR35BX224A(3)Z(4)
270,000	K,M	C1825N274(3)5X(4)L	CDR35BX274A(3)Z(4)
330,000	K,M	C1825N334(3)5X(4)L	CDR35BX334A(3)Z(4)
390,000	K,M	C1825N394(3)5X(4)L	CDR35BX394A(3)Z(4)
470,000	K,M	C1825N474(3)5X(4)L	CDR35BX474A(3)Z(4)

Ceramic Surface Mount

- (1) To complete Part Number for Dielectric, insert P or X symbol – as defined by Military specification.
- (2) To complete Part Number for Dielectric, insert G or X symbol. (“G” for Military “BP,” or “X” for Military “BX.”)
- (3) To complete Part Number, insert Capacitance Tolerance Symbol (when applicable) as available in MIL-PRF-55681: B – ±0.1 pF, C – ±0.25 pF, D – ±0.5pF, F – ±1%, J – ±5%, K – ±10%, M – ±20%. **NOTE: Available tolerances are listed in columns above.**
- (4) To complete Part Number, insert Failure Rate Symbol: M – 1.0%; P – 0.1%; R – 0.01%; S – .001%.

Note: All MIL-PRF-55681 and KEMET Part Numbers tabulated above assume use of MIL-PRF-55681 “Z”; KEMET “L” end metalization. If MIL-PRF-55681 “U” or “W” (KEMET “L”) or MIL-PRF-55681 “S” (KEMET “H”), or MIL-PRF-55681 “Y” (KEMET “C”) is required, please change designators.

MIL-PRF-55681 MAXIMUM INDIVIDUAL PACKAGING QUANTITIES

CHIP SIZE	REELED	BULK-STD BAG	BULK - ANTI-STATIC BAG	CHIP SIZE	REELED	BULK-STD BAG	BULK - ANTI-STATIC BAG
C0805	2,500	25,000	10,000	C1808	2,500	7,500	3,000
C1206	2,500	25,000	10,000	C1812	1,100	7,500	3,000
C1210	2,500	25,000	10,000	C1825	1,100	7,500	1,000
C1805	2,500	7,500	3,000	C2225	1,100	5,000	1,000

MIL-PRF-55681 chips available in 7" reels only.

Tape & Reel Packaging

KEMET offers Multilayer Ceramic Chip Capacitors packaged in 8mm and 12mm plastic tape on 7" and 13" reels in accordance with EIA standard 481-1: Taping of surface mount components for automatic handling. This packaging system is compatible with all tape fed automatic pick and place systems. See page 78 for details on reeling quantities for commercial chips and page 87 for MIL-PRF-55681 chips.

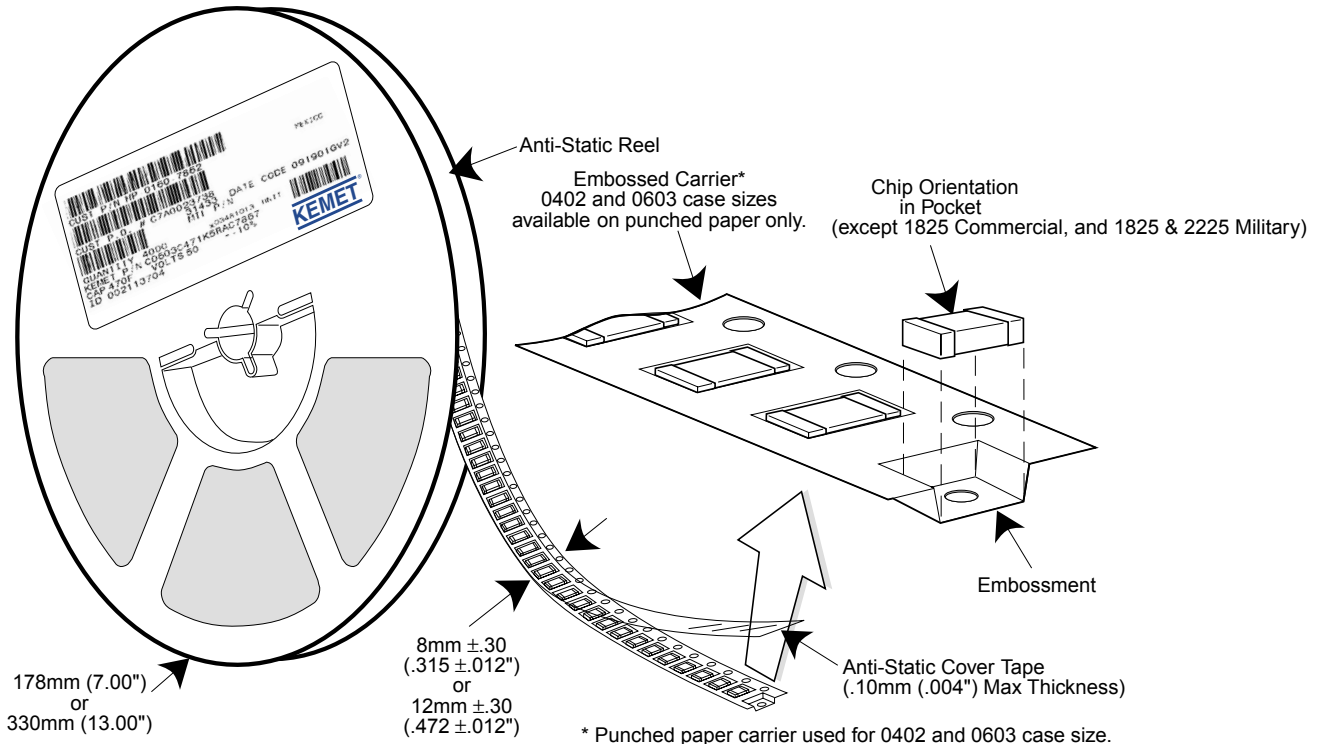

Case Sizes ≤ 1210 are 8 mm tape with 4 mm pitch.
Case Sizes >1210 are 12 mm tape with 8 mm pitch.

Note: TU suffix represents tape and reel packaging of unmarked components.
TM suffix represents tape and reel packaging of marked components.

SURFACE MOUNT LAND DIMENSIONS - CERAMIC CHIP CAPACITORS - MM

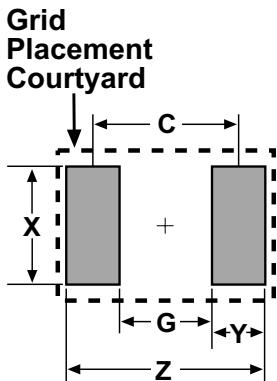

Dimension	Reflow Solder					Wave Solder				
	Z	G	X	Y(ref)	C(ref)	Z	G	X	Y(ref)	Smin
0402	2.14	0.28	0.74	0.93	1.21	Not Recommended				
0603	2.78	0.68	1.08	1.05	1.73	3.18	0.68	0.80	1.25	1.93
0805	3.30	0.70	1.60	1.30	2.00	3.70	0.70	1.10	1.50	2.20
1206	4.50	1.50	2.00	1.50	3.00	4.90	1.50	1.40	1.70	3.20
1210	4.50	1.50	2.90	1.50	3.00	4.90	1.50	2.00	1.70	3.20
1812	5.90	2.30	3.70	1.80	4.10	Not Recommended				
1825	5.90	2.30	6.90	1.80	4.10					
2220	7.00	3.30	5.50	1.85	5.15					
2225	7.00	3.30	6.80	1.85	5.15					

Calculation Formula
 $Z = L_{min} + 2J_t + T_t$
 $G = S_{max} - 2J_h - T_h$
 $X = W_{min} + 2J_s + T_s$
 $T_t, T_h, T_s =$ Combined tolerances

TANTALUM, CERAMIC AND ALUMINUM CHIP CAPACITORS

Packaging Information

Performance Notes

- Cover Tape Break Force:** 1.0 Kg Minimum.
- Cover Tape Peel Strength:** The total peel strength of the cover tape from the carrier tape shall be:

Tape Width	Peel Strength
8 mm	0.1 Newton to 1.0 Newton (10g to 100g)
12 mm	0.1 Newton to 1.3 Newton (10g to 130g)

The direction of the pull shall be opposite the direction of the carrier tape travel. The pull angle of the carrier tape shall be 165° to 180° from the plane of the carrier tape. During peeling, the carrier and/or cover tape shall be pulled at a velocity of 300 ±10 mm/minute.

- Reel Sizes:** Molded tantalum capacitors are available on either 180 mm (7") reels (standard) or 330 mm (13") reels (with C-7280). Note that 13" reels are preferred.
- Labeling:** Bar code labeling (standard or custom) shall be on the side of the reel opposite the sprocket holes. Refer to EIA-556.

Embossed Carrier Tape Configuration: Figure 1



Table 1 — EMBOSSED TAPE DIMENSIONS (Metric will govern)

Constant Dimensions — Millimeters (Inches)									
Tape Size	D ₀	E	P ₀	P ₂	T Max	T ₁ Max			
8 mm and 12 mm	1.5 +0.10 -0.0 (0.059 +0.004, -0.0)	1.75 ±0.10 (0.069 ±0.004)	4.0 ±0.10 (0.157 ±0.004)	2.0 ±0.05 (0.079 ±0.002)	0.600 (0.024)	0.100 (0.004)			
Variable Dimensions — Millimeters (Inches)									
Tape Size	Pitch	B ₁ Max. Note 1	D ₁ Min. Note 2	F	P ₁	R Min. Note 3	T ₂ Max	W	A ₀ B ₀ K ₀ Note 4
8 mm	Single (4 mm)	4.4 (0.173)	1.0 (0.039)	3.5 ±0.05 (0.138 ±0.002)	4.0 ±0.10 (0.157 ±0.004)	25.0 (0.984)	2.5 (0.098)	8.0 ±0.30 (.315 ±0.012)	
12 mm	Double (8 mm)	8.2 (0.323)	1.5 (0.059)	5.5 ±0.05 (0.217 ±0.002)	8.0 ±0.10 (0.315 ±0.004)	30.0 (1.181)	4.6 (0.181)	12.0 ±0.30 (0.472 ±0.012)	

NOTES

- B₁ dimension is a reference dimension for tape feeder clearance only.
- The embossment hole location shall be measured from the sprocket hole controlling the location of the embossment. Dimensions of embossment location and hole location shall be applied independent of each other.
- Tape with components shall pass around radius "R" without damage (see sketch A). The minimum trailer length (Fig. 2) may require additional length to provide R min. for 12 mm embossed tape for reels with hub diameters approaching N min. (Table 2)
- The cavity defined by A₀, B₀, and K₀ shall be configured to surround the part with sufficient clearance such that the chip does not protrude beyond the sealing plane of the cover tape, the chip can be removed from the cavity in a vertical direction without mechanical restriction, rotation of the chip is limited to 20 degrees maximum in all 3 planes, and lateral movement of the chip is restricted to 0.5 mm maximum in the pocket (not applicable to vertical clearance.)

Packaging Information

Embossed Carrier Tape Configuration (cont.)

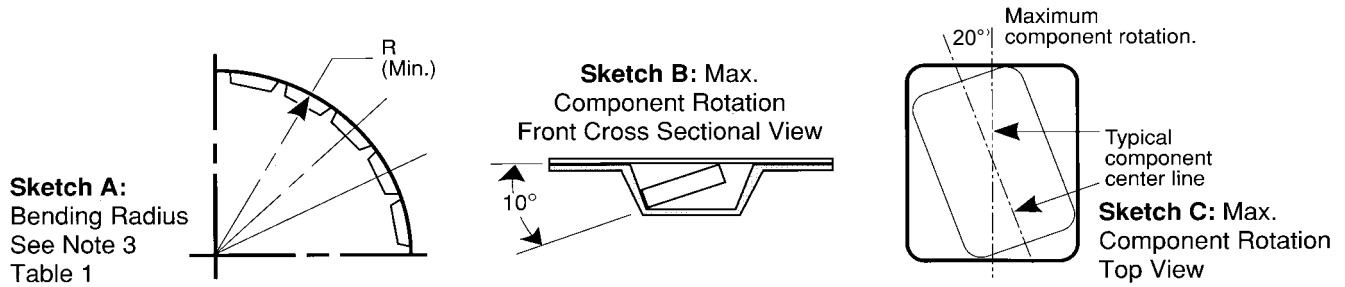

Sketch D: Tape Camber (Top View)



Figure 2: Tape Leader & Trailer Dimensions (Metric Dimensions Will Govern)

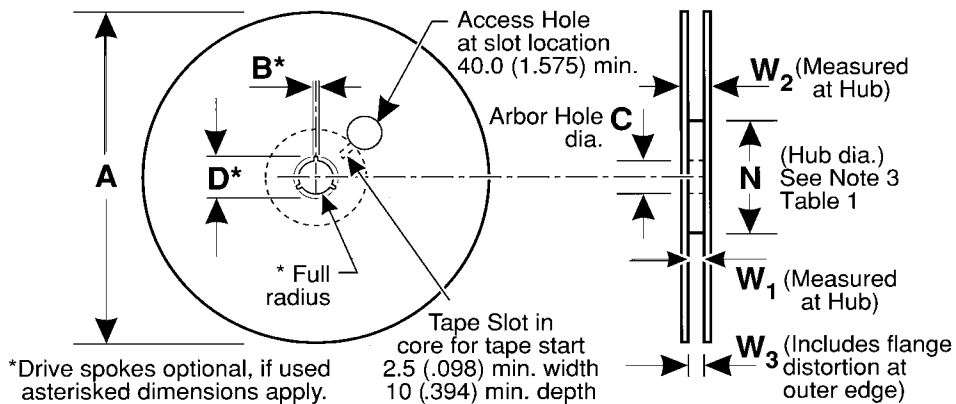

Figure 3: Reel Dimensions (Metric Dimensions will govern)

Table 2 – REEL DIMENSIONS (Metric will govern)

Tape Size	A Max	B^* Min	C	D^* Min	N Min	W_1	W_2 Max	W_3
8 mm	330.0 (12.992)	1.5 (0.059)	13.0 ± 0.20 (0.512 ± 0.008)	20.2 (0.795)	50.0 (1.969) See Note 3	8.4 +1.5, -0.0 (0.331) +0.059, -0.0)	14.4 (0.567)	7.9 Min (0.311) 10.9 Max (0.429)
12 mm	330.0 (12.992)	1.5 (0.059)	13.0 ± 0.20 (0.512 ± 0.008)	20.2 (0.795)	Table 1	12.4 +2.0, -0.0 (0.488) +0.078, -0.0)	18.4 (0.724)	11.9 Min (0.469) 15.4 Max (0.606)

Punched Carrier (Paper Tape) Configuration (Ceramic Chips Only):



Table 1: 8 & 12mm Punched Tape
(Metric Dimensions Will Govern)

Constant Dimensions - Millimeters (Inches)

Tape Size	D ₀	E	P ₀	P ₂	T ₁	G ₁	G ₂	R Min.
8mm and 12mm	1.5 +0.10, -0.0 (.059 +0.004, -0.0)	1.75 ±0.10 (.069 ±0.004)	4.0 ± 0.10 (.157 ± 0.004)	2.0 ± 0.05 (.079 ± 0.002)	0.10 (.004) Max.	0.75 (.030) Min.	0.75 (.030) Min.	25 (.984) See Note 2 Table 1

Table 1: 8 & 12mm Punched Tape
(Metric Dimensions Will Govern)

Variable Dimensions - Millimeters (Inches)

Tape Size	P ₁	F	W	A ₀ B ₀	T
8mm 1/2 Pitch	2.0 ± 0.10 (.079 ± .004) See Requirements Section 3.3 (d)	3.5 ± 0.05 (.138 ± .002)	8.0 ± 0.3 (.315 ± 0.012)	See Note 1 Table 1	1.1mm (.043) Max. for Paper Base Tape and 1.6mm (.063) Max. for Non- Paper Base Compositions. See Note 3.
8mm	4.0 ± 0.10 (0.157 ± .004)				
12mm	4.0 ± 0.10 (0.157 ± .004)	5.5 ± 0.05 (.217 ± .002)	12.0 ± 0.3 (.472 ± .012)		
12mm Double Pitch	8.0 ± 0.10 (0.315 ± .004)				

Note:

- A₀, B₀ and T determined by the maximum dimensions to the ends of the terminals extending from the body and/or the body dimensions of the component. The clearance between the ends of the terminals or body of the component to the sides and depth of the cavity (A₀, B₀ and T) must be within 0.05mm (.002) minimum and 0.50mm (.020) maximum. The clearance allowed must also prevent rotation of the component within the cavity of not more than 20 degrees (see sketches A and B).
- Tape with components shall pass around radius "R" without damage.
- KEMET nominal thicknesses are: 0402 = 0.6mm and all others 0.95mm minimum.

Sketch A:
Bending Radius
See Note 2
Table 1

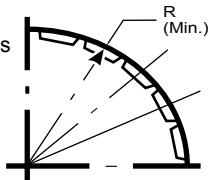

Sketch B:
Max. Component
Rotation - Front
Cross Sectional View

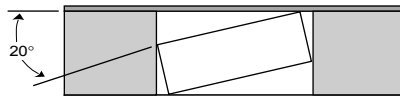

Sketch C:
Component Rotation - Top View



Bulk Cassette Packaging (Ceramic Chips only) (Meets Dimensional Requirements IEC-286-6 and EIAJ 7201)

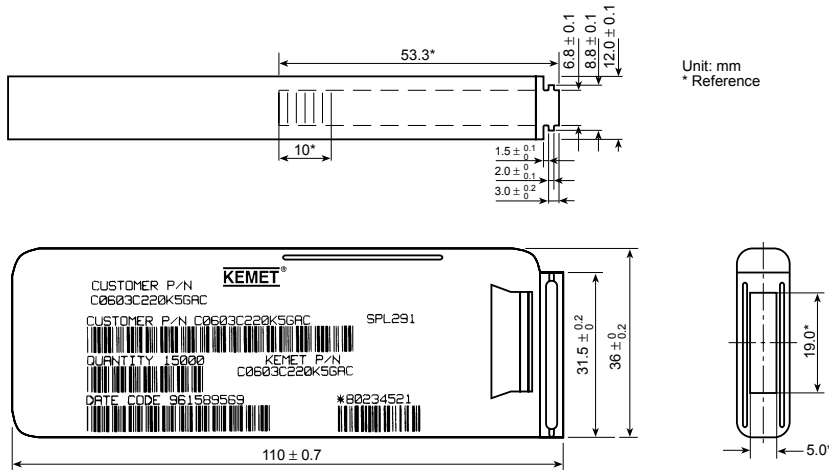

Table 2 – Capacitance Values Available In Bulk Cassette Packaging

Case Size	Dielectric	Voltage	Min. Cap Value	Max. Cap Value
0402	All	All	All	All
0603	All	All	All	All
0805	C0G	200	109	181
		100	109	331
		50	109	102
	X7R	200	221	392
		100	221	103
		50	221	273
		25	221	104
		16	221	104
	Y5V	25	104	224
		16	104	224

Table 1 – Capacitor Dimensions for Bulk Cassette Packaging – Millimeters

Metric Size Code	EIA Size Code	Length L	Width W	Thickness T	Bandwidth B	Minimum Separation S	Number of Pcs/Cassette
1005	0402	1.0 ± 0.05	0.5 ± 0.05	0.5 ± .05	0.2 to 0.4	0.3	50,000
1608	0603	1.6 ± 0.07	0.8 ± 0.07	0.8 ± .07	0.2 to 0.5	0.7	15,000
2012	0805	2.0 ± 0.10	1.25 ± 0.10	0.6 ± .10	0.5 to 0.75	0.75	10,000

Terminations: KEMET nickel barrier layer with a tin overplate.

CAPACITOR MARKING TABLE (Marking Optional - Not Available for 0402 Size or Y5V Dielectric)

Alpha Character	Capacitance (pF) For Various Numerical Identifiers						
	9	0	1	2	3	4	5
A	0.10	1.0	10	100	1000	10,000	100,000
B	0.11	1.1	11	110	1100	11,000	110,000
C	0.12	1.2	12	120	1200	12,000	120,000
D	0.13	1.3	13	130	1300	13,000	130,000
E	0.15	1.5	15	150	1500	15,000	150,000
F	0.16	1.6	16	160	1600	16,000	160,000
G	0.18	1.8	18	180	1800	18,000	180,000
H	0.20	2.0	20	200	2000	20,000	200,000
J	0.22	2.2	22	220	2200	22,000	220,000
K	0.24	2.4	24	240	2400	24,000	240,000
L	0.27	2.7	27	270	2700	27,000	270,000
M	0.30	3.0	30	300	3000	30,000	300,000
N	0.33	3.3	33	330	3300	33,000	330,000
P	0.36	3.6	36	360	3600	36,000	360,000
Q	0.39	3.9	39	390	3900	39,000	390,000
R	0.43	4.3	43	430	4300	43,000	430,000
S	0.47	4.7	47	470	4700	47,000	470,000
T	0.51	5.1	51	510	5100	51,000	510,000
U	0.56	5.6	56	560	5600	56,000	560,000
V	0.62	6.2	62	620	6200	62,000	620,000
W	0.68	6.8	68	680	6800	68,000	680,000
X	0.75	7.5	75	750	7500	75,000	750,000
Y	0.82	8.2	82	820	8200	82,000	820,000
Z	0.91	9.1	91	910	9100	91,000	910,000
a	0.25	2.5	25	250	2500	25,000	250,000
b	0.35	3.5	35	350	3500	35,000	350,000
d	0.40	4.0	40	400	4000	40,000	400,000
e	0.45	4.5	45	450	4500	45,000	450,000
f	0.50	5.0	50	500	5000	50,000	500,000
m	0.60	6.0	60	600	6000	60,000	600,000
n	0.70	7.0	70	700	7000	70,000	700,000
t	0.80	8.0	80	800	8000	80,000	800,000
y	0.90	9.0	90	900	9000	90,000	900,000

Laser marking is available as an extra-cost option for most KEMET ceramic chips. Such marking is two sided, and includes a \bar{K} to identify KEMET, followed by two characters (per EIA-198 - see table below) to identify the capacitance value. Note that marking is not available for size 0402 nor for any Y5V chip. In addition, the 0603 marking option is limited to the \bar{K} only.

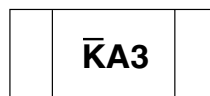

Example shown is 1,000 pF capacitor.