

Multilayer Chip Inductors

CL Series

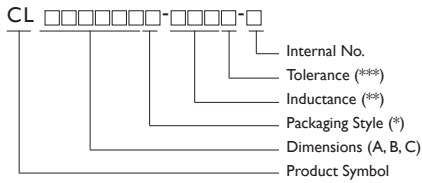

PRODUCT IDENTIFICATION



* B: Bulk ; T: Tape and Reel

** Example : 47N = 47nH

R10 = 0.1μH IR0 = 1.0μH

*** K = ±10% M = ±20%

■ YAGEO will start to release lead-free that meet SONY SS-00259's criteria, and Internal No. will be changed to "N" as identification.

Ex. CL160808T-10NM-N

APPLICATIONS

Personal computers, HDDs, or other various electronic appliances.

Any general circuit of portable equipment in which compact size and high mounting densities are required.

OUTLINE

Yageo's SMD multi-layered ferrite chip inductors provide a cost-effective solution for densely packed PC board designs. CL series comes in 4 sizes and is suitable for low frequency applications

FEATURES

High mounting density of compact circuit due to crosstalk elimination that results from a closed magnetic flux in a ferrite material.

Suitable for Flow and Re-flow Soldering

Available in 4 Sizes

SHAPES AND DIMENSIONS

Dimensions : mm

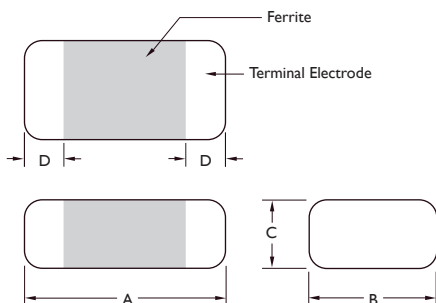

TYPE	A	B	C	D
CL160808	1.6 ± 0.20	0.80 ± 0.15	0.80 ± 0.15	0.3 ± 0.2
CL201209	2.0 ± 0.20	1.25 ± 0.20	0.90 ± 0.20	0.5 ± 0.3
CL201212	2.0 ± 0.20	1.25 ± 0.20	1.25 ± 0.20	0.5 ± 0.3
CL321611	3.2 ± 0.20	1.60 ± 0.20	1.10 ± 0.20	0.5 ± 0.3



ELECTRICAL CHARACTERISTICS CL060808 (0603) SERIES

PART NO.	INDUCTANCE (μ H)	TOLERANCE (\pm %)	Q Min.	TEST FREQUENCY (MHz)	SRF (MHz) Min.	DC RESISTANCE (Ω) Max.	IDC (mA) Max.
CL160808T-10NM-S	0.010	20%	15	50	300	0.20	50
CL160808T-33NM-S	0.033	20%	15	50	270	0.20	50
CL160808T-47NM-S	0.047	20%	15	50	260	0.30	50
CL160808T-56NM-S	0.056	20%	15	50	255	0.30	50
CL160808T-68NM-S	0.068	20%	15	50	250	0.30	50
CL160808T-82NM-S	0.082	20%	15	50	245	0.30	50
CL160808T-R10 \square -S	0.10	20 or 10%	25	25	240	0.50	50
CL160808T-R12 \square -S	0.12	20 or 10%	25	25	205	0.50	50
CL160808T-R15 \square -S	0.15	20 or 10%	25	25	180	0.60	50
CL160808T-R18 \square -S	0.18	20 or 10%	25	25	165	0.60	50
CL160808T-R22 \square -S	0.22	20 or 10%	25	25	150	0.80	50
CL160808T-R27 \square -S	0.27	20 or 10%	25	25	136	0.80	50
CL160808T-R33 \square -S	0.33	20 or 10%	25	25	125	0.85	35
CL160808T-R39 \square -S	0.39	20 or 10%	25	25	110	1.00	35
CL160808T-R47 \square -S	0.47	20 or 10%	25	25	105	1.35	35
CL160808T-R56 \square -S	0.56	20 or 10%	25	25	95	1.50	35
CL160808T-R68 \square -S	0.68	20 or 10%	25	25	85	1.70	35
CL160808T-R82 \square -S	0.82	20 or 10%	25	25	75	2.10	35
CL160808T-1R0 \square -S	1.0	20 or 10%	35	10	65	0.60	25
CL160808T-1R2 \square -S	1.2	20 or 10%	35	10	60	0.80	25
CL160808T-1R5 \square -S	1.5	20 or 10%	35	10	55	0.80	25
CL160808T-1R8 \square -S	1.8	20 or 10%	35	10	50	0.95	25
CL160808T-2R2 \square -S	2.2	20 or 10%	35	10	45	1.10	15
CL160808T-2R7 \square -S	2.7	20 or 10%	35	10	40	1.30	15
CL160808T-3R3 \square -S	3.3	20 or 10%	35	10	38	1.50	15
CL160808T-3R9 \square -S	3.9	20 or 10%	35	10	36	1.70	15
CL160808T-4R7 \square -S	4.7	20 or 10%	35	10	33	2.10	15
CL160808T-5R6 \square -S	5.6	20 or 10%	35	4	22	1.50	5
CL160808T-6R8 \square -S	6.8	20 or 10%	35	4	20	1.70	5
CL160808T-8R2 \square -S	8.2	20 or 10%	30	4	18	2.10	5
CL160808T-100 \square -S	10	20 or 10%	30	2	17	2.55	5



ELECTRICAL CHARACTERISTICS : LEAD-FREE & ROHS COMPLIANCE

PART NO.	INDUCTANCE	L,Q Test Freq	Q	SRF	RDC	IDC	TOLERANCE
	(μ H)	(MHZ)	Min	(MHZ)Min.	(Ω)Max.	(mA)Max	(\pm %)
CL160808T-10N □-N	0.01	50MHZ,200mV	15	300	0.2	50	20,15
CL160808T-33N □-N	0.033	50MHZ,200mV	15	270	0.2	50	20,15
CL160808T-47N □-N	0.047	50MHZ,200mV	15	260	0.3	50	20,15
CL160808T-56N □-N	0.056	50MHZ,200mV	15	255	0.3	50	20,15
CL160808T-68N □-N	0.068	50MHZ,200mV	15	250	0.3	50	20,15
CL160808T-82N □-N	0.082	50MHZ,200mV	15	245	0.3	50	20,15
CL160808T-R10 □-N	0.1	25MHZ,200mV	25	240	0.5	50	20,15,10
CL160808T-R12 □-N	0.12	25MHZ,200mV	25	205	0.5	50	20,15,10
CL160808T-R15 □-N	0.15	25MHZ,200mV	25	180	0.6	50	20,15,10
CL160808T-R18 □-N	0.18	25MHZ,200mV	25	165	0.6	50	20,15,10
CL160808T-R22 □-N	0.22	25MHZ,200mV	25	150	0.8	50	20,15,10
CL160808T-R27 □-N	0.27	25MHZ,200mV	25	136	0.8	50	20,15,10
CL160808T-R33 □-N	0.33	25MHZ,200mV	25	125	0.85	35	20,15,10
CL160808T-R39 □-N	0.39	25MHZ,200mV	25	110	1	35	20,15,10
CL160808T-R47 □-N	0.47	25MHZ,200mV	25	105	1.35	35	20,15,10
CL160808T-R56 □-N	0.56	25MHZ,200mV	25	95	1.5	35	20,15,10
CL160808T-R68 □-N	0.68	25MHZ,200mV	25	85	1.7	35	20,15,10
CL160808T-R82 □-N	0.82	25MHZ,200mV	25	75	2.1	35	20,15,10
CL160808T-1R0 □-N	1	10MHZ,200mV	35	65	0.6	25	20,15,10
CL160808T-1R2 □-N	1.2	10MHZ,200mV	35	60	0.8	25	20,15,10
CL160808T-1R5 □-N	1.5	10MHZ,200mV	35	55	0.8	25	20,15,10
CL160808T-1R8 □-N	1.8	10MHZ,200mV	35	50	0.95	25	20,15,10
CL160808T-2R2 □-N	2.2	10MHZ,200mV	35	45	1.1	15	20,15,10
CL160808T-2R7 □-N	2.7	10MHZ,200mV	35	40	1.3	15	20,15,10
CL160808T-3R3 □-N	3.3	10MHZ,200mV	35	38	1.5	15	20,15,10
CL160808T-3R9 □-N	3.9	10MHZ,200mV	35	36	1.7	15	20,15,10
CL160808T-4R7 □-N	4.7	10MHZ,200mV	35	33	2.1	15	20,15,10
CL160808T-5R6 □-N	5.6	4MHZ,200mV	35	22	1.5	5	20,15,10
CL160808T-6R8 □-N	6.8	4MHZ,200mV	35	20	1.7	5	20,15,10
CL160808T-8R2 □-N	8.2	4MHZ,100mV	30	18	2.1	5	20,15,10
CL160808T-100 □-N	10	2MHZ,100mV	30	17	2.55	5	20,15,10
CL160808T-120 □-N	12	2MHZ,60mV	30	15	2.6	3	20,15,10
CL160808T-150 □-N	15	1MHZ,60mV	20	14	1.7	1	20,15,10
CL160808T-180 □-N	18	1MHZ,60mV	20	13	1.8	1	20,15,10
CL160808T-220 □-N	22	1MHZ,60mV	20	11	2.1	1	20,15,10
CL160808T-270 □-N	27	1MHZ,60mV	20	10	2.7	1	20,15,10
CL160808T-330 □-N	33	1MHZ,60mV	20	9	2.9	1	20,15,10

NOTE: □-tolerance K= \pm 10% / L= \pm 15% / M= \pm 20%

1. Operating temperature range -25°C~85°C

2.IDC: Applied the current to coils, the inductance shall be less than 10% initial value.

"-N" FOR COMPLETELY LEAD FREE TYPE(INCLUDING FERRITE BODY & SOLDER)



ELECTRICAL CHARACTERISTICS CL201209, CL201212 (0805) SERIES

PART NO.	INDUCTANCE (μ H)	TOLERANCE (\pm %)	Q Min.	TEST FREQUENCY (MHz)	SRF (MHz) Min.	DC RESISTANCE (Ω) Max.	IDC (mA) Max.
CL201209T-47NM-S	0.047	20%	20	50	320	0.20	300
CL201209T-68NM-S	0.068	20%	20	50	280	0.20	300
CL201209T-82NM-S	0.082	20%	20	50	255	0.20	300
CL201209T-R10 □-S	0.10	20 or 10%	25	25	235	0.30	250
CL201209T-R12 □-S	0.12	20 or 10%	25	25	220	0.30	250
CL201209T-R15 □-S	0.15	20 or 10%	25	25	200	0.40	250
CL201209T-R18 □-S	0.18	20 or 10%	25	25	185	0.40	250
CL201209T-R22 □-S	0.22	20 or 10%	25	25	170	0.50	250
CL201209T-R27 □-S	0.27	20 or 10%	25	25	150	0.50	250
CL201209T-R33 □-S	0.33	20 or 10%	25	25	145	0.55	250
CL201209T-R39 □-S	0.39	20 or 10%	25	25	135	0.65	250
CL201209T-R47 □-S	0.47	20 or 10%	25	25	125	0.65	250
CL201209T-R56 □-S	0.56	20 or 10%	25	25	115	0.75	150
CL201209T-R68 □-S	0.68	20 or 10%	25	25	105	0.80	150
CL201209T-R82 □-S	0.82	20 or 10%	25	25	100	1.00	150
CL201209T-1R0 □-S	1.0	20 or 10%	45	10	75	0.40	50
CL201209T-1R2 □-S	1.2	20 or 10%	45	10	65	0.50	50
CL201209T-1R5 □-S	1.5	20 or 10%	45	10	60	0.50	50
CL201209T-1R8 □-S	1.8	20 or 10%	45	10	55	0.60	50
CL201209T-2R2 □-S	2.2	20 or 10%	45	10	50	0.65	30
CL201212T-2R7 □-S	2.7	20 or 10%	45	10	45	0.75	30
CL201212T-3R3 □-S	3.3	20 or 10%	45	10	41	0.80	30
CL201212T-3R9 □-S	3.9	20 or 10%	45	10	38	0.90	30
CL201212T-4R7 □-S	4.7	20 or 10%	45	10	35	1.00	30
CL201212T-5R6 □-S	5.6	20 or 10%	45	4	32	0.90	15
CL201212T-6R8 □-S	6.8	20 or 10%	45	4	29	1.00	15
CL201212T-8R2 □-S	8.2	20 or 10%	45	4	26	1.10	15
CL201212T-100 □-S	10	20 or 10%	45	2	24	1.10	15
CL201212T-120 □-S	12	20 or 10%	45	2	22	1.20	15
CL201212T-150 □-S	15	20 or 10%	30	1	19	0.80	5
CL201212T-180 □-S	18	20 or 10%	30	1	18	0.90	5
CL201212T-220 □-S	22	20 or 10%	30	1	16	1.10	5



ELECTRICAL CHARACTERISTICS : LEAD-FREE & ROHS COMPLIANCE

PART NO.	INDUCTANCE (μ H)	L,Q Test Freq (MHZ)	Q Min	SRF (MHZ)Min.	RDC (Ω)Max.	IDC (mA)Max	TOLERANCE (\pm %)
CL201209T-22N <input type="checkbox"/> -N	0.022	50MHZ,200mV	20	320	0.2	300	20,15
CL201209T-33N <input type="checkbox"/> -N	0.033	50MHZ,200mV	20	320	0.2	300	20,15
CL201209T-47N <input type="checkbox"/> -N	0.047	50MHZ,200mV	20	320	0.2	300	20,15
CL201209T-56N <input type="checkbox"/> -N	0.056	50MHZ,200mV	20	320	0.2	300	20,15
CL201209T-68N <input type="checkbox"/> -N	0.068	50MHZ,200mV	20	280	0.2	300	20,15
CL201209T-82N <input type="checkbox"/> -N	0.082	50MHZ,200mV	20	255	0.2	300	20,15
CL201209T-R10 <input type="checkbox"/> -N	0.1	25MHZ,200mV	25	235	0.3	250	20,15,10
CL201209T-R12 <input type="checkbox"/> -N	0.12	25MHZ,200mV	25	220	0.3	250	20,15,10
CL201209T-R15 <input type="checkbox"/> -N	0.15	25MHZ,200mV	25	200	0.4	250	20,15,10
CL201209T-R18 <input type="checkbox"/> -N	0.18	25MHZ,200mV	25	185	0.4	250	20,15,10
CL201209T-R22 <input type="checkbox"/> -N	0.22	25MHZ,200mV	25	170	0.5	250	20,15,10
CL201209T-R27 <input type="checkbox"/> -N	0.27	25MHZ,200mV	25	150	0.5	250	20,15,10
CL201209T-R33 <input type="checkbox"/> -N	0.33	25MHZ,200mV	25	145	0.55	250	20,15,10
CL201209T-R39 <input type="checkbox"/> -N	0.39	25MHZ,200mV	25	135	0.65	250	20,15,10
CL201209T-R47 <input type="checkbox"/> -N	0.47	25MHZ,200mV	25	125	0.65	250	20,15,10
CL201209T-R56 <input type="checkbox"/> -N	0.56	25MHZ,200mV	25	115	0.75	150	20,15,10
CL201209T-R68 <input type="checkbox"/> -N	0.68	25MHZ,200mV	25	105	0.8	150	20,15,10
CL201209T-R82 <input type="checkbox"/> -N	0.82	25MHZ,200mV	25	100	1	150	20,15,10
CL201209T-1R0 <input type="checkbox"/> -N	1	10MHZ,200mV	45	75	0.4	50	20,15,10
CL201209T-1R2 <input type="checkbox"/> -N	1.2	10MHZ,200mV	45	65	0.5	50	20,15,10
CL201209T-1R5 <input type="checkbox"/> -N	1.5	10MHZ,200mV	45	60	0.5	50	20,15,10
CL201209T-1R8 <input type="checkbox"/> -N	1.8	10MHZ,200mV	45	55	0.6	50	20,15,10
CL201209T-2R2 <input type="checkbox"/> -N	2.2	10MHZ,200mV	45	50	0.65	30	20,15,10
CL201212T-2R7 <input type="checkbox"/> -N	2.7	10MHZ,200mV	45	45	0.75	30	20,15,10
CL201212T-3R3 <input type="checkbox"/> -N	3.3	10MHZ,200mV	45	41	0.8	30	20,15,10
CL201212T-3R9 <input type="checkbox"/> -N	3.9	10MHZ,200mV	45	38	0.9	30	20,15,10
CL201212T-4R7 <input type="checkbox"/> -N	4.7	10MHZ,200mV	45	35	1	30	20,15,10
CL201212T-5R6 <input type="checkbox"/> -N	5.6	4MHZ,200mV	45	32	0.9	15	20,15,10
CL201212T-6R8 <input type="checkbox"/> -N	6.8	4MHZ,200mV	45	29	1	15	20,15,10
CL201212T-8R2 <input type="checkbox"/> -N	8.2	4MHZ,200mV	45	26	1.1	15	20,15,10
CL201212T-100 <input type="checkbox"/> -N	10	2MHZ,60mV	45	24	1.1	15	20,15,10
CL201212T-120 <input type="checkbox"/> -N	12	2MHZ,60mV	45	22	1.2	15	20,15,10
CL201212T-150 <input type="checkbox"/> -N	15	1MHZ,60mV	30	19	0.8	5	20,15,10



ELECTRICAL CHARACTERISTICS : LEAD-FREE & ROHS COMPLIANCE

PART NO.	INDUCTANCE (μ H)	L,Q Test Freq (MHZ)	Q (MHZ)Min.	SRF (Ω)Max.	RDC (mA)Max	IDC (\pm %)	TOLERANCE
CL201212T-180 □ -N	18	1MHZ,60mV	30	18	0.9	5	20,15,10
CL201212T-220 □ -N	22	1MHZ,60mV	30	16	1.1	5	20,15,10
CL201212T-330 □ -N	33	1MHZ,60mV	30	13	1.25	5	20,15,10

NOTE: □-tolerance K= \pm 10% / L= \pm 15% / M= \pm 20%

1.Operating temperature range -25°C~85°C

2.IDC:Applied the current to coils,the inductance shall be less than 10% initial value.

"-N"FOR COMPLETELY LEAD FREE TYPE(INCLUDING FERRITE BODY & SOLDER)



ELECTRICAL CHARACTERISTICS CL321611 (1206) SERIES

PART NO.	INDUCTANCE (μ H)	TOLERANCE (\pm %)	Q Min.	TEST FREQUENCY (MHz)	SRF (MHz) Min.	DC RESISTANCE (Ω) Max.	IDC (mA) Max.
CL321611T-47NM-S	0.047	20%	20	50	320	0.15	300
CL321611T-68NM-S	0.068	20%	20	50	280	0.25	300
CL321611T-82NM-S	0.082	20%	20	50	250	0.25	300
CL321611T-R10 □-S	0.10	20 or 10%	25	25	235	0.25	250
CL321611T-R12 □-S	0.12	20 or 10%	25	25	220	0.30	250
CL321611T-R15 □-S	0.15	20 or 10%	25	25	200	0.30	250
CL321611T-R18 □-S	0.18	20 or 10%	25	25	185	0.40	250
CL321611T-R22 □-S	0.22	20 or 10%	25	25	170	0.40	250
CL321611T-R27 □-S	0.27	20 or 10%	25	25	150	0.50	250
CL321611T-R33 □-S	0.33	20 or 10%	25	25	145	0.60	250
CL321611T-R39 □-S	0.39	20 or 10%	25	25	135	0.50	200
CL321611T-R47 □-S	0.47	20 or 10%	25	25	125	0.60	200
CL321611T-R56 □-S	0.56	20 or 10%	25	25	115	0.70	150
CL321611T-R68 □-S	0.68	20 or 10%	25	25	105	0.80	150
CL321611T-R82 □-S	0.82	20 or 10%	25	25	100	0.90	150
CL321611T-IR0 □-S	1.0	20 or 10%	45	10	75	0.40	100
CL321611T-IR2 □-S	1.2	20 or 10%	45	10	65	0.50	100
CL321611T-IR5 □-S	1.5	20 or 10%	45	10	60	0.50	80
CL321611T-IR8 □-S	1.8	20 or 10%	45	10	55	0.50	70
CL321611T-2R2 □-S	2.2	20 or 10%	45	10	50	0.60	60
CL321611T-2R7 □-S	2.7	20 or 10%	45	10	45	0.60	60
CL321611T-3R3 □-S	3.3	20 or 10%	45	10	41	0.70	60
CL321611T-3R9 □-S	3.9	20 or 10%	45	10	38	0.80	50
CL321611T-4R7 □-S	4.7	20 or 10%	45	10	35	0.90	50
CL321611T-5R6 □-S	5.6	20 or 10%	45	4	32	0.70	25
CL321611T-6R8 □-S	6.8	20 or 10%	45	4	29	0.80	25
CL321611T-8R2 □-S	8.2	20 or 10%	45	4	26	0.90	25
CL321611T-100 □-S	10	20 or 10%	45	2	24	1.00	25
CL321611T-120 □-S	12	20 or 10%	45	2	22	1.00	15
CL321611T-150 □-S	15	20 or 10%	35	1	19	0.70	5
CL321611T-180 □-S	18	20 or 10%	35	1	18	0.75	5
CL321611T-220 □-S	22	20 or 10%	35	1	16	0.90	5
CL321611T-270 □-S	27	20 or 10%	35	1	14	0.90	5
CL321611T-330 □-S	33	20 or 10%	35	1	13	1.05	5



ELECTRICAL CHARACTERISTICS : LEAD-FREE & ROHS COMPLIANCE

PART NO.	INDUCTANCE	L,Q TEST FREQ	Q	SRF	RDC	IDC	TOLERANCE
	(μ H)		Min.				
CL32161IT-47N □ -N	0.047	50MHZ,200mV	20	320	0.15	300	20,15
CL32161IT-56N □ -N	0.056	50MHZ,200mV	20	280	0.25	300	20,15
CL32161IT-68N □ -N	0.068	50MHZ,200mV	20	280	0.25	300	20,15
CL32161IT-82N □ -N	0.082	50MHZ,200mV	20	250	0.25	300	20,15
CL32161IT-R10 □ -N	0.1	25MHZ,200mV	25	235	0.25	250	20,15,10
CL32161IT-R12 □ -N	0.12	25MHZ,200mV	25	220	0.3	250	20,15,10
CL32161IT-R15 □ -N	0.15	25MHZ,200mV	25	200	0.3	250	20,15,10
CL32161IT-R18 □ -N	0.18	25MHZ,200mV	25	185	0.4	250	20,15,10
CL32161IT-R22 □ -N	0.22	25MHZ,200mV	25	170	0.4	250	20,15,10
CL32161IT-R27 □ -N	0.27	25MHZ,200mV	25	150	0.5	250	20,15,10
CL32161IT-R33 □ -N	0.33	25MHZ,200mV	25	145	0.6	250	20,15,10
CL32161IT-R39 □ -N	0.39	25MHZ,200mV	25	135	0.5	200	20,15,10
CL32161IT-R47 □ -N	0.47	25MHZ,200mV	25	125	0.6	200	20,15,10
CL32161IT-R56 □ -N	0.56	25MHZ,200mV	25	115	0.7	150	20,15,10
CL32161IT-R68 □ -N	0.68	25MHZ,200mV	25	105	0.8	150	20,15,10
CL32161IT-R82 □ -N	0.82	25MHZ,200mV	25	100	0.9	150	20,15,10
CL32161IT-R10 □ -N	1	10MHZ,200mV	45	75	0.4	100	20,15,10
CL32161IT-R12 □ -N	1.2	10MHZ,200mV	45	65	0.5	100	20,15,10
CL32161IT-R15 □ -N	1.5	10MHZ,200mV	45	60	0.5	80	20,15,10
CL32161IT-R18 □ -N	1.8	10MHZ,200mV	45	55	0.5	70	20,15,10
CL32161IT-2R2 □ -N	2.2	10MHZ,200mV	45	50	0.6	60	20,15,10
CL32161IT-2R7 □ -N	2.7	10MHZ,200mV	45	45	0.6	60	20,15,10
CL32161IT-3R3 □ -N	3.3	10MHZ,200mV	45	41	0.7	60	20,15,10
CL32161IT-3R9 □ -N	3.9	10MHZ,200mV	45	38	0.8	50	20,15,10
CL32161IT-4R7 □ -N	4.7	10MHZ,200mV	45	35	0.9	50	20,15,10
CL32161IT-5R6 □ -N	5.6	4MHZ,200mV	45	32	0.7	25	20,15,10
CL32161IT-6R8 □ -N	6.8	4MHZ,200mV	45	29	0.8	25	20,15,10
CL32161IT-8R2 □ -N	8.2	4MHZ,200mV	45	26	0.9	25	20,15,10
CL32161IT-100 □ -N	10	2MHZ,60mV	45	24	1	25	20,15,10
CL32161IT-120 □ -N	12	2MHZ,60mV	45	22	1	15	20,15,10
CL32161IT-150 □ -N	15	1MHZ,60mV	35	19	0.7	5	20,15,10
CL32161IT-180 □ -N	18	1MHZ,60mV	35	18	0.75	5	20,15,10
CL32161IT-220 □ -N	22	1MHZ,60mV	35	16	0.9	5	20,15,10
CL32161IT-270 □ -N	27	1MHZ,60mV	35	14	0.9	5	20,15,10
CL32161IT-330 □ -N	33	1MHZ,60mV	35	13	1.05	5	20,15,10

NOTE: □-tolerance K= \pm 10% / L= \pm 15% / M= \pm 20%

1.Operating temperature range -25°C~85°C

2.IDC:Applied the current to coils,the inductance shall be less than 10% initial value.

"-N"FOR COMPLETELY LEAD FREE TYPE(INCLUDING FERRITE BODY & SOLDER)



TAPE DIMENSIONS

Dimensions : mm

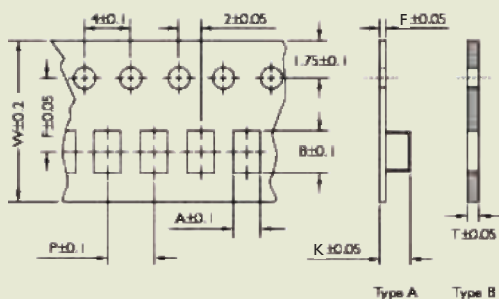

TYPE	A	B	T	W	P	F	K	TAPE TYPE
CL160808	1.05	1.8	0.95	8.0	4.0	3.5	-	B
CL201209	1.42	2.30	0.22	8.0	4.0	3.5	1.04	A
CL201212	1.35	2.25	0.22	8.0	4.0	3.5	1.35	A
CL321611	1.88	3.50	0.22	8.0	4.0	3.5	1.27	A

TAPE MATERIAL

Carrier Tape : Polystyrene (for 201209, 201212, 321611 Series), Paper (for 160808)

Cover Type : Polyethyene

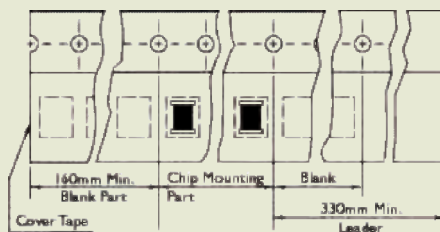

REEL DIMENSIONS

Dimensions : mm

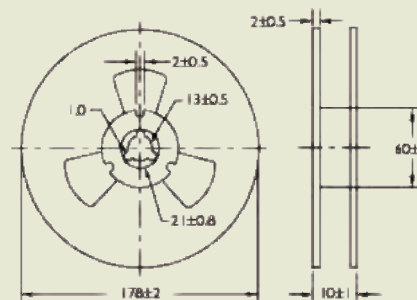

RECOMMENDED PATTERN

Dimensions : mm

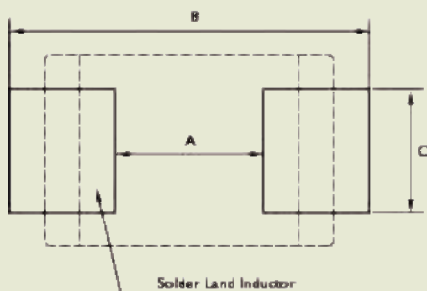

TYPE	A	B	C
CL160808	0.8	2.4 ~ 3.4	0.6
CL201209	1.2	3.0 ~ 4.0	1.0
CL201212	1.2	3.0 ~ 4.0	1.0
CL321611	2.0	4.2 ~ 5.2	1.2

PACKAGING QUANTITY

TYPE	BULK	QUANTITY/REEL
CL160808	√	4000
CL201209	√	4000
CL201212	√	3000
CL321611	√	3000



TYPICAL ELECTRICAL CHARACTERISTICS

Test Instruments : HP4291A Impedance / Material Analyzer

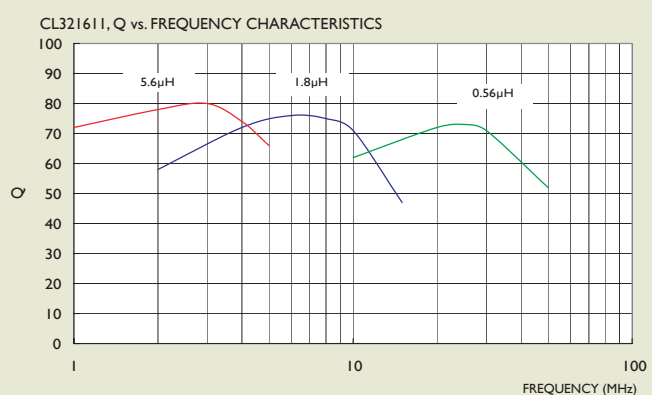
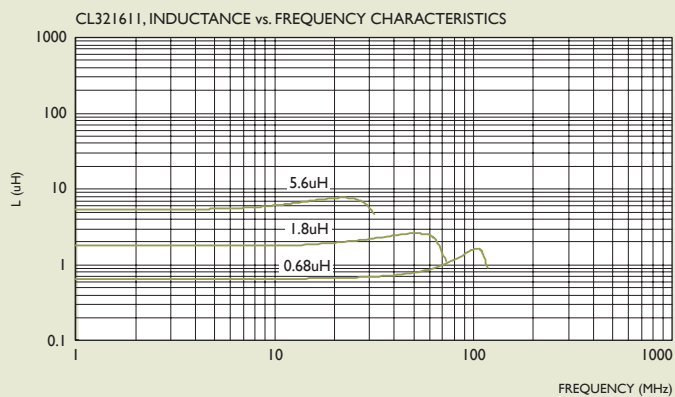
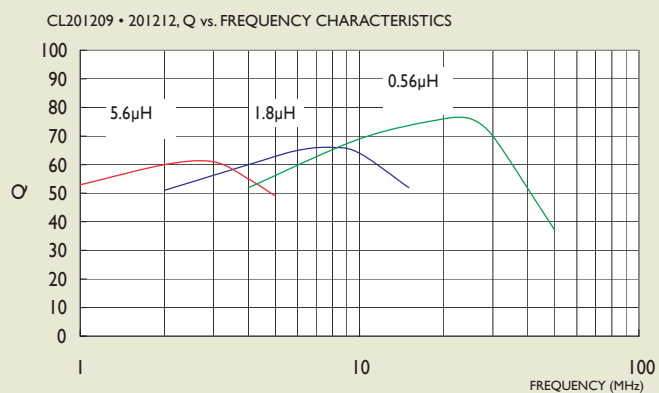
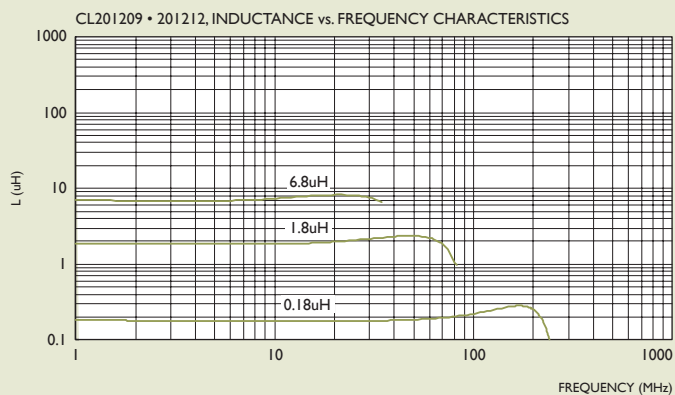
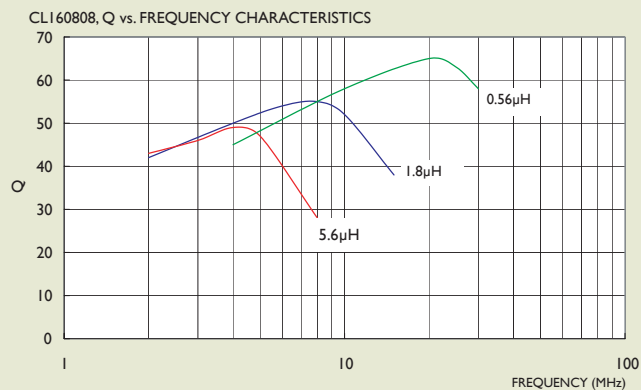
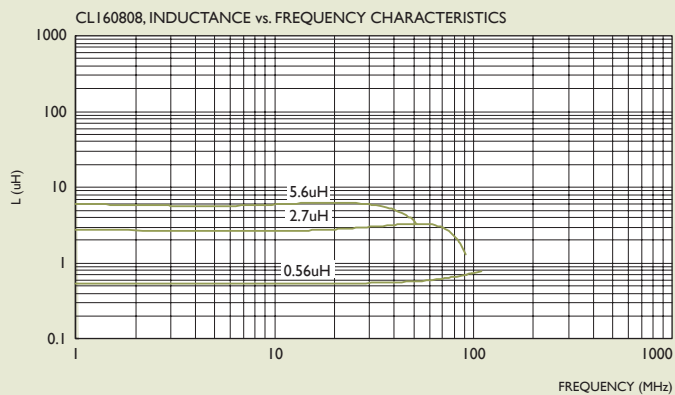



CL SERIES RELIABILITY TEST

I-1 MECHANICAL PERFORMANCE

NO.	ITEM	SPECIFICATION	TEST CONDITIONS
I-1-1	Flexure Strength	Appearance : No Damage L Change : within $\pm 10\%$ Q Change : within $\pm 30\%$	Test device shall be soldered on the substrate. Substrate Dimension : 100 x 40 x 1.6mm Deflection : 2.0mm Keeping Time : 30Sec. * For 100505, substrate dimension is 100 x 40 x 0.8mm.
I-1-2	Vibration		Test device shall be soldered on the substrate. Oscillation Frequency : 10 to 55 to 10Hz for 1Min. Amplitude : 1.5mm Time : 2Hrs. for each Axis (X, Y & Z), Total 6Hrs.
I-1-3	Resistance to Soldering Heat	Appearance : No Damage	Pre-heating : 150°C, 1Min. Solder Composition : Sn/Pb = 63/37 Solder Temperature : 260 \pm 5°C Immersion Time : 10 \pm 1Sec.
I-1-4	Solderability	The electrodes shall be at least 90% covered with new solder coating.	Pre-heating : 150°C, 1Min. Solder Composition : Sn/Pb = 63/37 Solder Temperature : 230 \pm 5°C Immersion Time : 4 \pm 1Sec.

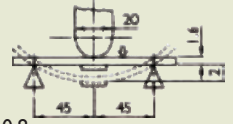

I-2 ENVIRONMENTAL PERFORMANCE

NO.	ITEM	SPECIFICATION	TEST CONDITIONS															
I-2-1	Temperature Cycle	Appearance : No Damage L Change : within $\pm 10\%$ Q Change : within $\pm 30\%$	One Cycle <table border="1"> <thead> <tr> <th>Step</th> <th>Temperature (°C)</th> <th>Time (Min.)</th> </tr> </thead> <tbody> <tr> <td>1</td> <td>-25 \pm 3</td> <td>30</td> </tr> <tr> <td>2</td> <td>25 \pm 2</td> <td>3</td> </tr> <tr> <td>3</td> <td>85 \pm 3</td> <td>30</td> </tr> <tr> <td>4</td> <td>25 \pm 2</td> <td>3</td> </tr> </tbody> </table> Total : 100 Cycles Measured after Exposure in the Room Condition for 24Hrs.	Step	Temperature (°C)	Time (Min.)	1	-25 \pm 3	30	2	25 \pm 2	3	3	85 \pm 3	30	4	25 \pm 2	3
Step	Temperature (°C)	Time (Min.)																
1	-25 \pm 3	30																
2	25 \pm 2	3																
3	85 \pm 3	30																
4	25 \pm 2	3																
I-2-2	Humidity Resistance		Temperature : 40 \pm 2°C Relative Humidity : 90 ~ 95% Time : 1000Hrs. Measured after Exposure in the Room Condition for 24Hrs.															
I-2-3	High Temperature Resistance		Temperature : 85 \pm 3°C Relative Humidity : 20% Applied Current : Rated Current Time : 1000Hrs. Measured after Exposure in the Room Condition for 24Hrs.															
I-2-4	Low Temperature Resistance		Temperature : -25 \pm 3°C Relative Humidity : 0% Time : 1000Hrs. Measured after Exposure in the Room Condition for 24Hrs.															



RECOMMEND SOLDERING CONDITIONS

for: CL/ CLH/ SQV/ SMD power inductors/ SMD Chip Beads/ SMD Filters, Transformers, Current Sensors

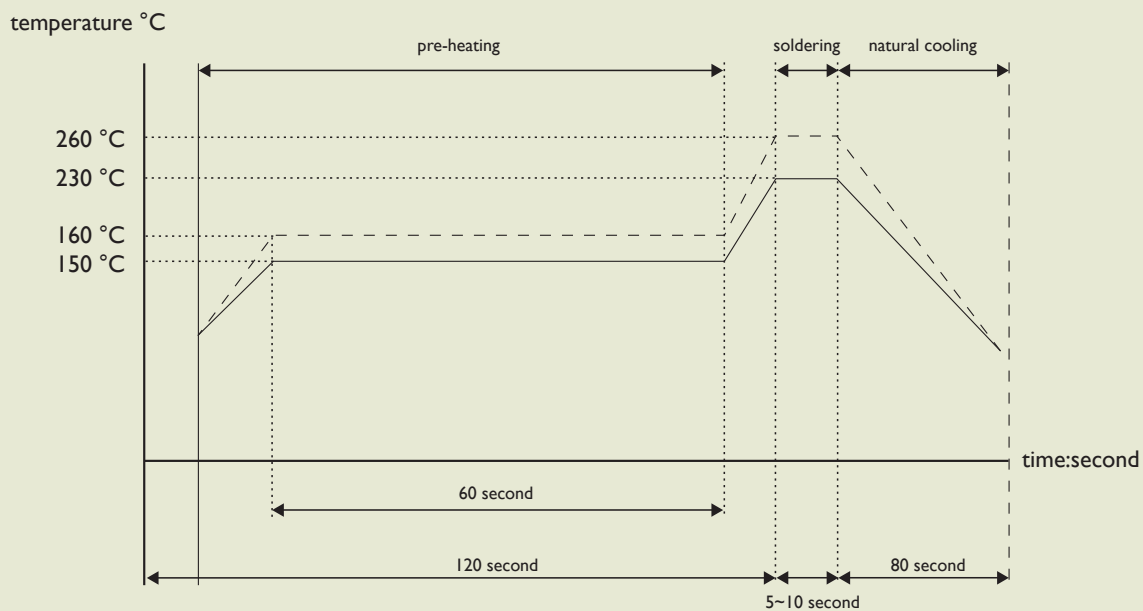

for: lead solder

—————

for: lead-free solder

.....