

General Multilayer Ceramic Capacitors

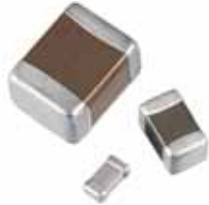

MLCC is an electronic part that temporarily stores an electrical charge and the most prevalent type of capacitor today. New technologies have enabled the MLCC manufacturers to follow the trend dictated by smaller and smaller electronic devices such as Cellular telephones, Computers, DSC, DVC

General Features

- Miniature Size
- Wide Capacitance and Voltage Range
- Tape & Reel for Surface Mount Assembly
- Low ESR

Applications

- General Electronic Circuit

Part Numbering

CL 10 B 104 K B 8 N N N C
1 2 3 4 5 6 7 8 9 10 11

Samsung Multilayer Ceramic Capacitor
Size(mm)
Capacitance Temperature Characteristic
Nominal Capacitance
Capacitance Tolerance
Rated Voltage

Thickness Option
Product & Plating Method
Samsung Control Code
Reserved For Future Use
Packaging Type

Samsung Multilayer Ceramic Capacitor

SIZE(mm)

Code	EIA CODE	Size(mm)
03	0201	0.6 × 0.3
05	0402	1.0 × 0.5
10	0603	1.6 × 0.8
21	0805	2.0 × 1.25
31	1206	3.2 × 1.6
32	1210	3.2 × 2.5
43	1812	4.5 × 3.2
55	2220	5.7 × 5.0

CAPACITANCE TEMPERATURE CHARACTERISTIC

Code	Temperature Characteristics				Temperature Range
C	Class	COG	C	$0 \pm 30(\text{ppm}/^\circ\text{C})$	-55 ~ +125
P		P2H	P	-150 ± 60	
R		R2H	R	-220 ± 60	
S		S2H	S	-330 ± 60	
T		T2H	T	-470 ± 60	
U		U2J	U	-750 ± 60	
L		S2L	S	$+350 \sim -1000$	
A	Class	X5R	X5R	$\pm 15\%$	-55 ~ +85
B		X7R	X7R	$\pm 15\%$	-55 ~ +125
X		X6S	X6S	$\pm 22\%$	-55 ~ +105
F		Y5V	Y5V	$+22 \sim -82\%$	-30 ~ +85

Temperature Characteristic

Temperature Characteristics	Below 2.0pF	2.2 ~ 3.9pF	Above 4.0pF	Above 10pF
C	C0G	C0G	C0G	C0G
P	-	P2J	P2H	P2H
R	-	R2J	R2H	R2H
S	-	S2J	S2H	S2H
T	-	T2J	T2H	T2H
U	-	U2J	U2J	U2J

J : $\pm 120\text{PPM}/^\circ\text{C}$, H : $\pm 60\text{PPM}/^\circ\text{C}$, G : $\pm 30\text{PPM}/^\circ\text{C}$

NOMINAL CAPACITANCE

Nominal capacitance is identified by 3 digits.

The first and second digits identify the first and second significant figures of the capacitance.

The third digit identifies the multiplier. 'R' identifies a decimal point.

Example

Code	Nominal Capacitance
1R5	1.5pF
103	10,000pF, 10nF, 0.01 μF
104	100,000pF, 100nF, 0.1 μF

CAPACITANCE TOLERANCE

Code	Tolerance	Nominal Capacitance
A	$\pm 0.05\text{pF}$	Less than 10pF (Including 10pF)
B	$\pm 0.1\text{pF}$	
C	$\pm 0.25\text{pF}$	
D	$\pm 0.5\text{pF}$	
F	$\pm 1\text{pF}$	
F	$\pm 1\%$	More than 10pF
G	$\pm 2\%$	
J	$\pm 5\%$	
K	$\pm 10\%$	
M	$\pm 20\%$	
Z	+80, -20%	

RATED VOLTAGE

Code	Rated Voltage	Code	Rated Voltage
R	4.0V	D	200V
Q	6.3V	E	250V
P	10V	G	500V
O	16V	H	630V
A	25V	I	1,000V
L	35V	J	2,000V
B	50V	K	3,000V
C	100V		



THICKNESS OPTION

Size	Code	Thickness(T)	Size	Code	Thickness(T)
0201(0603)	3	0.30±0.03	1812(4532)	F	1.25±0.20
0402(1005)	5	0.50±0.05		H	1.6±0.20
0603(1608)	8	0.80±0.10		I	2.0±0.20
0805(2012)	A	0.65±0.10		J	2.5±0.20
	C	0.85±0.10		L	3.2±0.30
	F	1.25±0.10	2220(5750)	F	1.25±0.20
1206(3216)	Q	1.25±0.15		H	1.6±0.20
	C	0.85±0.15		I	2.0±0.20
	F	1.25±0.15		J	2.5±0.20
1210(3225)	H	1.6±0.20		L	3.2±0.30
	F	1.25±0.20			
	H	1.6±0.20			
1210(3225)	I	2.0±0.20			
	J	2.5±0.20			
	V	2.5±0.30			

General Capacitors

PRODUCT & PLATING METHOD

Code	Electrode	Termination	Plating Type
A	Pd	Ag	Sn_100%
N	Ni	Cu	Sn_100%
G	Cu	Cu	Sn_100%

SAMSUNG CONTROL CODE

Code	Description of the code	Code	Description of the code
A	Array (2-element)	N	Normal
B	Array (4-element)	P	Automotive
C	High - Q	L	LICC

RESERVED FOR FUTURE USE

Code	Description of the code
N	Reserved for future use

PACKAGING TYPE

Code	Packaging Type	Code	Packaging Type
B	Bulk	F	Embossing 13" (10,000EA)
P	Bulk Case	L	Paper 13" (15,000EA)
C	Paper 7"	O	Paper 10"
D	Paper 13" (10,000EA)	S	Embossing 10"
E	Embossing 7"		

APPEARANCE AND DIMENSION

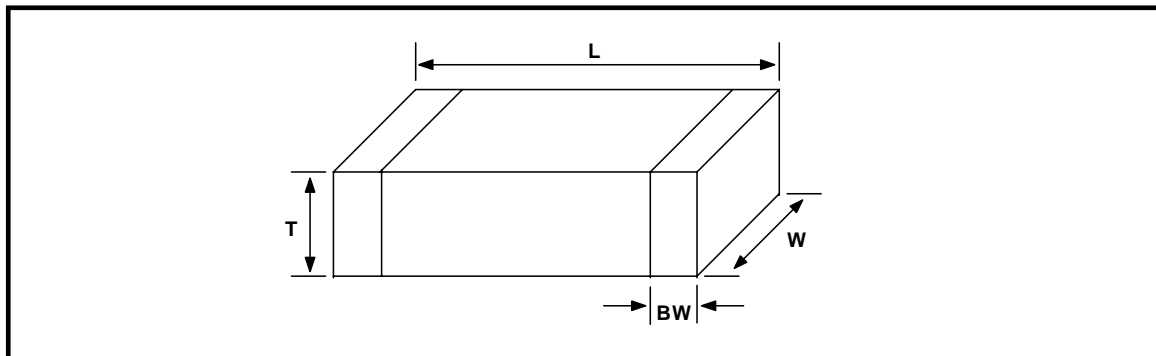

CODE	EIA CODE	DIMENSION (mm)			
		L	W	T (MAX)	BW
03	0201	0.6 ± 0.03	0.3 ± 0.03	0.33	0.15 ± 0.05
05	0402	1.0 ± 0.05	0.5 ± 0.05	0.55	0.2 +0.15/-0.1
10	0603	1.6 ± 0.1	0.8 ± 0.1	0.9	0.3 ± 0.2
21	0805	2.0 ± 0.1	1.25 ± 0.1	1.35	0.5 +0.2/-0.3
31	1206	3.2 ± 0.15	1.6 ± 0.15	1.40	0.5 +0.2/-0.3
		3.2 ± 0.2	1.6 ± 0.2	1.8	0.5 +0.3/-0.3
32	1210	3.2 ± 0.3	2.5 ± 0.2	2.7	0.6 ± 0.3
		3.2 ± 0.4	2.5 ± 0.3	2.8	
43	1812	4.5 ± 0.4	3.2 ± 0.3	3.5	0.8 ± 0.3
55	2220	5.7 ± 0.4	5.0 ± 0.4	3.5	1.0 ± 0.3

RELIABILITY TEST CONDITION

NO	ITEM	PERFORMANCE	TEST CONDITION																										
1	Appearance	No Abnormal Exterior Appearance	Through Microscope(x10)																										
2	Insulation Resistance	10,000MΩ or 500MΩ·μF whichever is smaller Rated Voltage is below 16V ; 10,000MΩ or 100MΩ·μF whichever is smaller	Apply the Rated Voltage For 60 ~ 120 Sec.																										
3	Withstanding Voltage	No Dielectric Breakdown or Mechanical Breakdown	Class : 300% of the Rated Voltage for 1~5 sec. Class :250% of the Rated Voltage for 1~5 sec. is applied with less than 50mA current																										
4	Capacitance	Class Within the specified tolerance	Capacitance	Frequency	Voltage 0.5 ~ 5 Vrms																								
			1,000pF	1kHz ±10%																									
		Class Within the specified tolerance	Capacitance	Frequency	Voltage 1.0±0.2Vrms																								
			>1,000pF	1kHz ±10%																									
5	Q	Class Capacitance 30pF : Q 1,000 < 30pF: Q 400 +20C (C : Capacitance)	Capacitance	Frequency	Voltage 0.5 ~ 5 Vrms																								
			1,000pF	1kHz ±10%																									
			>1,000pF	1kHz ±10%																									
			Capacitance	Frequency		Voltage 1.0±0.2Vrms																							
10 μF	1kHz ±10%																												
>10 μF	120Hz±20%	0.5±0.1Vrms																											
6	Tan	Class 1. Characteristic : A(X5R), B(X7R), X(X6S) <table border="1" data-bbox="414 1064 893 1232"> <thead> <tr> <th>Rated Voltage</th> <th>Spec</th> </tr> </thead> <tbody> <tr> <td>25V</td> <td>0.025 max</td> </tr> <tr> <td>16V</td> <td>0.035 max</td> </tr> <tr> <td>10V</td> <td>0.05 max</td> </tr> <tr> <td>6.3V</td> <td>0.05 max/ 0.10max*1</td> </tr> </tbody> </table> 2. Characteristic : F(Y5V) <table border="1" data-bbox="414 1321 893 1579"> <thead> <tr> <th>Rated Voltage</th> <th>Spec</th> </tr> </thead> <tbody> <tr> <td>50V</td> <td>0.05 max, 0.07max*2</td> </tr> <tr> <td>35V</td> <td>0.07 max</td> </tr> <tr> <td>25V</td> <td>0.05 max/ 0.07 max*3/ 0.09max*4</td> </tr> <tr> <td>16V</td> <td>0.09 max/ 0.125max*5</td> </tr> <tr> <td>10V</td> <td>0.125 max/ 0.16max*6</td> </tr> <tr> <td>6.3V</td> <td>0.16max</td> </tr> </tbody> </table>	Rated Voltage	Spec	25V		0.025 max	16V	0.035 max	10V	0.05 max	6.3V	0.05 max/ 0.10max*1	Rated Voltage	Spec	50V	0.05 max, 0.07max*2	35V	0.07 max	25V	0.05 max/ 0.07 max*3/ 0.09max*4	16V	0.09 max/ 0.125max*5	10V	0.125 max/ 0.16max*6	6.3V	0.16max	Capacitance	Frequency
			Rated Voltage	Spec																									
			25V	0.025 max																									
			16V	0.035 max																									
			10V	0.05 max																									
			6.3V	0.05 max/ 0.10max*1																									
			Rated Voltage	Spec																									
			50V	0.05 max, 0.07max*2																									
			35V	0.07 max																									
			25V	0.05 max/ 0.07 max*3/ 0.09max*4																									
			16V	0.09 max/ 0.125max*5																									
			10V	0.125 max/ 0.16max*6																									
			6.3V	0.16max																									
			10 μF	1kHz ±10%																									
>10 μF	120Hz±20%	0.5±0.1Vrms																											
*1. 0201 C 0.022uF, 0402 C 0.22uF, 0603 C 2.2uF, 0805 C 4.7uF, 1206 C 10uF, 1210 C 22uF, 1812 C 47uF, 2220 C 100uF, All Low Profile Capacitors (P.16).																													
*2.. 0603 C 0.47uF, 0805 C 1uF																													
*3. 0402 C 0.033uF, 0603 C>0.1uF All 0805, 1206 size, 1210 C 6.8uF																													
*4.. 1210 C>6.8uF																													
*5.. 0402 C 0.22uF																													
*6.. All 1812 size																													

RELIABILITY TEST CONDITION

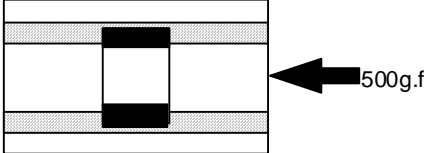
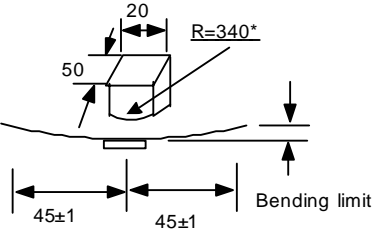
NO	ITEM		PERFORMANCE		TEST CONDITION																												
7	Temperature Characteristics of Capacitance	Class	<table border="1"> <thead> <tr> <th>Characteristics</th> <th>Temp. Coefficient (PPM/)</th> </tr> </thead> <tbody> <tr> <td>C0G</td> <td>0 ± 30</td> </tr> <tr> <td>PH</td> <td>-150 ± 60</td> </tr> <tr> <td>RH</td> <td>-220 ± 60</td> </tr> <tr> <td>SH</td> <td>-330 ± 60</td> </tr> <tr> <td>TH</td> <td>-470 ± 60</td> </tr> <tr> <td>UL</td> <td>-750 ± 120</td> </tr> <tr> <td>SL</td> <td>+350 ~ -1000</td> </tr> </tbody> </table>	Characteristics	Temp. Coefficient (PPM/)	C0G	0 ± 30	PH	-150 ± 60	RH	-220 ± 60	SH	-330 ± 60	TH	-470 ± 60	UL	-750 ± 120	SL	+350 ~ -1000		<p>Capacitance shall be measured by the steps shown in the following table.</p> <table border="1"> <thead> <tr> <th>Step</th> <th>Temp.()</th> </tr> </thead> <tbody> <tr> <td>1</td> <td>25 ± 2</td> </tr> <tr> <td>2</td> <td>Min. operating temp. ± 2</td> </tr> <tr> <td>3</td> <td>25 ± 2</td> </tr> <tr> <td>4</td> <td>Max. operating temp ± 2</td> </tr> <tr> <td>5</td> <td>25 ± 2</td> </tr> </tbody> </table> <p>(1) Class Temperature Coefficient shall be calculated from the formula as below. Temp. Coefficient = $\frac{C2 - C1}{C1 \times T} \times 10^6$ [ppm/] C1; Capacitance at step 3 C2: Capacitance at 85 T: 60 (=85 -25)</p> <p>(2) CLASS Capacitance Change shall be calculated from the formula as below. $C = \frac{C2 - C1}{C1} \times 100(\%)$ C1; Capacitance at step 3 C2: Capacitance at step 2 or 4</p>	Step	Temp.()	1	25 ± 2	2	Min. operating temp. ± 2	3	25 ± 2	4	Max. operating temp ± 2	5	25 ± 2
		Characteristics	Temp. Coefficient (PPM/)																														
C0G	0 ± 30																																
PH	-150 ± 60																																
RH	-220 ± 60																																
SH	-330 ± 60																																
TH	-470 ± 60																																
UL	-750 ± 120																																
SL	+350 ~ -1000																																
Step	Temp.()																																
1	25 ± 2																																
2	Min. operating temp. ± 2																																
3	25 ± 2																																
4	Max. operating temp ± 2																																
5	25 ± 2																																
Class	<table border="1"> <thead> <tr> <th>Characteristics</th> <th>Capacitance Change with No Bias</th> </tr> </thead> <tbody> <tr> <td>A(X5R)/ B(X7R)</td> <td>±15%</td> </tr> <tr> <td>X(X6S)</td> <td>±22%</td> </tr> <tr> <td>F(Y5V)</td> <td>+22% ~ -82%</td> </tr> </tbody> </table>	Characteristics	Capacitance Change with No Bias	A(X5R)/ B(X7R)	±15%	X(X6S)	±22%	F(Y5V)	+22% ~ -82%																								
Characteristics	Capacitance Change with No Bias																																
A(X5R)/ B(X7R)	±15%																																
X(X6S)	±22%																																
F(Y5V)	+22% ~ -82%																																
8	Adhesive Strength of Termination	No Indication Of Peeling Shall Occur On The Terminal Electrode.			<p>Apply 500g.f * Pressure for 10±1 sec. * 200g.f for 0201 case size.</p> 																												
9	Bending Strength	Apperance	No mechanical damage shall occur.		<p>Bending limit ; 1mm Test speed ; 1.0mm/SEC. Keep the test board at the limit point in 5 sec., Then measure capacitance.</p>  <p><u>R=230 For 0201 Case size</u></p>																												
		Capacitance	<table border="1"> <thead> <tr> <th>Characteristics</th> <th>Capacitance Change</th> </tr> </thead> <tbody> <tr> <td>Class I</td> <td>Within ±5% or ± 0.5 pF whichever is larger</td> </tr> <tr> <td rowspan="2">Class II</td> <td>A(X5R)/ B(X7R)/ X(X6S)</td> <td>Within ±12.5%</td> </tr> <tr> <td>F(Y5V)</td> <td>Within ±30%</td> </tr> </tbody> </table>	Characteristics		Capacitance Change	Class I	Within ±5% or ± 0.5 pF whichever is larger	Class II	A(X5R)/ B(X7R)/ X(X6S)	Within ±12.5%	F(Y5V)	Within ±30%																				
Characteristics	Capacitance Change																																
Class I	Within ±5% or ± 0.5 pF whichever is larger																																
Class II	A(X5R)/ B(X7R)/ X(X6S)	Within ±12.5%																															
	F(Y5V)	Within ±30%																															

RELIABILITY TEST CONDITION

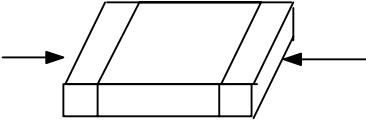
NO	ITEM	PERFORMANCE	TEST CONDITION																							
10	Solderability	<p>More Than 95% of the terminal surface is to be soldered newly, So metal part does not come out or dissolve</p> 	<table border="1"> <tr> <td>Solder</td> <td>Sn-3Ag-0.5Cu</td> <td>63Sn-37Pb</td> </tr> <tr> <td>Solder Temp.</td> <td>245±5</td> <td>235±5</td> </tr> <tr> <td>Flux</td> <td colspan="2">RMA Type</td> </tr> <tr> <td>Dip Time</td> <td>3±0.3 sec.</td> <td>5±0.5 sec.</td> </tr> <tr> <td>Pre-heating</td> <td colspan="2">at 80~120 for 10~30 sec.</td> </tr> </table>	Solder	Sn-3Ag-0.5Cu	63Sn-37Pb	Solder Temp.	245±5	235±5	Flux	RMA Type		Dip Time	3±0.3 sec.	5±0.5 sec.	Pre-heating	at 80~120 for 10~30 sec.									
Solder	Sn-3Ag-0.5Cu	63Sn-37Pb																								
Solder Temp.	245±5	235±5																								
Flux	RMA Type																									
Dip Time	3±0.3 sec.	5±0.5 sec.																								
Pre-heating	at 80~120 for 10~30 sec.																									
11	Resistance to Soldering heat	<p>Appearance: No mechanical damage shall occur.</p> <table border="1"> <tr> <td rowspan="2">Capacitance</td> <td>Characteristics</td> <td>Capacitance Change</td> </tr> <tr> <td>Class</td> <td>Within ±2.5% or ±0.25pF whichever is larger</td> </tr> <tr> <td rowspan="4">Class</td> <td>A(X5R)/ B(X7R)</td> <td>Within ±7.5%</td> </tr> <tr> <td>X(X6S)</td> <td>Within ±15%</td> </tr> <tr> <td>F</td> <td>Within ±20%</td> </tr> <tr> <td></td> <td></td> </tr> </table> <p>Q (Class) : Capacitance 30pF : Q 1000 <30pF : Q 400+20×C (C: Capacitance)</p> <p>Tan (Class) : Within the specified initial value</p> <p>Insulation Resistance : Within the specified initial value</p> <p>Withstanding Voltage : Within the specified initial value</p>	Capacitance	Characteristics	Capacitance Change	Class	Within ±2.5% or ±0.25pF whichever is larger	Class	A(X5R)/ B(X7R)	Within ±7.5%	X(X6S)	Within ±15%	F	Within ±20%			<p>Solder Temperature : 270±5</p> <p>Dip Time : 10±1 sec.</p> <p>Each termination shall be fully immersed and preheated as below :</p> <table border="1"> <thead> <tr> <th>STEP</th> <th>TEMP.()</th> <th>TIME(SEC.)</th> </tr> </thead> <tbody> <tr> <td>1</td> <td>80~100</td> <td>60</td> </tr> <tr> <td>2</td> <td>150~180</td> <td>60</td> </tr> </tbody> </table> <p>Leave the capacitor in ambient condition for specified time* before measurement</p> <p>* 24 ± 2 hours (Class) 48 ± 4 hours (Class)</p>	STEP	TEMP.()	TIME(SEC.)	1	80~100	60	2	150~180	60
Capacitance	Characteristics	Capacitance Change																								
	Class	Within ±2.5% or ±0.25pF whichever is larger																								
Class	A(X5R)/ B(X7R)	Within ±7.5%																								
	X(X6S)	Within ±15%																								
	F	Within ±20%																								
STEP	TEMP.()	TIME(SEC.)																								
1	80~100	60																								
2	150~180	60																								
12	Vibration Test	<p>Appearance: No mechanical damage shall occur.</p> <table border="1"> <tr> <td rowspan="2">Capacitance</td> <td>Characteristics</td> <td>Capacitance Change</td> </tr> <tr> <td>Class</td> <td>Within ±2.5% or ±0.25pF whichever is larger</td> </tr> <tr> <td rowspan="4">Class</td> <td>A(X5R)/ B(X7R)</td> <td>Within ±5%</td> </tr> <tr> <td>X(X6S)</td> <td>Within ±10%</td> </tr> <tr> <td>F(Y5V)</td> <td>Within ±20%</td> </tr> <tr> <td></td> <td></td> </tr> </table> <p>Q (Class) : Within the specified initial value</p> <p>Tan (Class) : Within the specified initial value</p> <p>Insulation Resistance : Within the specified initial value</p>	Capacitance	Characteristics	Capacitance Change	Class	Within ±2.5% or ±0.25pF whichever is larger	Class	A(X5R)/ B(X7R)	Within ±5%	X(X6S)	Within ±10%	F(Y5V)	Within ±20%			<p>The capacitor shall be subjected to a Harmonic Motion having a total amplitude of 1.5mm changing frequency from 10Hz to 55Hz and back to 10Hz In 1 min.</p> <p>Repeat this for 2hours each in 3 mutually perpendicular directions</p>									
Capacitance	Characteristics	Capacitance Change																								
	Class	Within ±2.5% or ±0.25pF whichever is larger																								
Class	A(X5R)/ B(X7R)	Within ±5%																								
	X(X6S)	Within ±10%																								
	F(Y5V)	Within ±20%																								

RELIABILITY TEST CONDITION

NO	ITEM	PERFORMANCE		TEST CONDITION		
13	Humidity (Steady State)	Appearance	No mechanical damage shall occur.		Temperature : 40±2 Relative humidity : 90~95 %RH Duration time : 500 +12/-0 hr. Leave the capacitor in ambient condition for specified time* before measurement. CLASS : 24±2 Hr. CLASS : 48±4 Hr.	
		Capacitance	Characteristics			Capacitance Change
			Class			Within ±5.0% or ±0.5pF whichever is larger
			Class	A(X5R)/ B(X7R)/ X(X6S)		Within ±12.5%
				F(Y5V)		Within ±30%
		Q CLASS	Capacitance 30pF : Q 350 10 Capacitance <30pF : Q 275 + 2.5xC Capacitance < 10pF : Q 200 + 10xC (C: Capacitance)			
Tan CLASS	1. Characteristic : A(X5R), B(X7R) 0.05max (16V and over) 0.075max (10V) 0.075max (6.3V except Table 1) 0.125max* (refer to Table 1)	2. Characteristic : F(Y5V) 0.075max (25V and over) 0.1max (16V, C<1.0μF) 0.125max(16V, C 1.0μF) 0.15max (10V) 0.195max (6.3V)				
Insulation Resistance	1,000 MΩ or 50MΩ·μF whichever is smaller.					
14	Moisture Resistance	Appearance	No mechanical damage shall occur.		Applied Voltage : rated voltage Temperature : 40±2 Humidity : :90~95%RH Duration Time : 500 +12/-0 Hr. Charge/Discharge Current : 50mA max. Perform the initial measurement according to Note1. Perform the final measurement according to Note2.	
		Capacitance	Characteristics			Capacitance Change
			Class			Within ±5.0% or ±0.5pF whichever is larger
			Class	A(X5R)/ B(X7R)/ X(X6S)		Within ±12.5% Within ±12.5% Within ±30%
				F(Y5V)		Within ±30% Within +30~ - 40% In case of Table 2 *
		Q (Class)	Capacitance 30pF : Q 200 Capacitance <30pF : Q 100 + 10/3xC (C: Capacitance)			
Tan (Class)	1. Characteristic : A(X5R), B(X7R) 0.05max (16V and over) 0.075max (10V) 0.075max (6.3V except Table 1) 0.125max* (refer to Table 1)	2. Characteristic : F(Y5V) 0.075max (25V and over) 0.1max (16V, C<1.0μF) 0.125max(16V, C 1.0μF) 0.15max (10V) 0.195max (6.3V)				
Insulation Resistance	500 MΩ or 25MΩ·μF whichever is smaller.					

RELIABILITY TEST CONDITION

		Recommended Soldering Method				
		Size inch (mm)	Temperature Characteristic	Capacitance	Condition	
					Flow	Reflow
18	Recommended Soldering Method By Size & Capacitance	0201 (0603)	-	-	-	
		0402 (1005)				
		0603 (1608)	Class I	-		
			Class II	C < 1 μ F		
		0805 (2012)	Class I	-		
			Class II	C < 4.7 μ F		
			Array	-	-	
		1206 (3216)	Class I	-		
			Class II	C < 10 μ F		
			Array	-	-	
		1210 (3225)	-	-	-	
		1808 (4520)				
		1812 (4532)				
2220 (5750)						

Note1. Initial Measurement For Class

Perform the heat treatment at 150 \pm 0/-10 for 1 hour. Then Leave the capacitor in ambient condition for 48 \pm 4 hours before measurement. Then perform the measurement.

Note2. Latter Measurement

1. CLASS

Leave the capacitor in ambient condition for 24 \pm 2 hours before measurement. Then perform the measurement.

2. Class

Perform the heat treatment at 150 \pm 0/-10 for 1 hour. Then Leave the capacitor in ambient condition for 48 \pm 4 hours before measurement. Then perform the measurement.

*Table1.

Tan	0.125max*
Class A(X5R), B(X7R)	0201 C 0.022 μ F
	0402 C 0.22 μ F
	0603 C 2.2 μ F
	0805 C 4.7 μ F
	1206 C 10.0 μ F
	1210 C 22.0 μ F
	1812 C 47.0 μ F
	2220 C 100.0 μ F
All Low Profile Capacitors (P.16).	

*Table2.

High Temperature Resistance test	
C (Y5V)	+30~ - 40%
Class F(Y5V)	0402 C 0.47 μ F
	0603 C 2.2 μ F
	0805 C 4.7 μ F
	1206 C 10.0 μ F
	1210 C 22.0 μ F
	1812 C 47.0 μ F
	2220 C 100.0 μ F

*Table3.

High Temperature Resistance test		
Applied Voltage	100% of the rated voltage	150% of the rated voltage
Class A(X5R), B(X7R), X(X6S), F(Y5V)	0201 C 0.1 μ F	0201 C 0.022 μ F
	0402 C 1.0 μ F	0402 C 0.47 μ F
	0603 C 4.7 μ F	0603 C 2.2 μ F
	0805 C 22.0 μ F	0805 C 4.7 μ F
	1206 C 47.0 μ F	1206 C 10.0 μ F
	1210 C 100.0 μ F	1210 C 22.0 μ F
	All Low Profile	1812 C 47.0 μ F
	Capacitors (P.16).	2220 C 100.0 μ F

Note3. All Size In Reliability Test Condition Section is "inch"

PACKAGING

CARDBOARD PAPER TAPE (4mm)

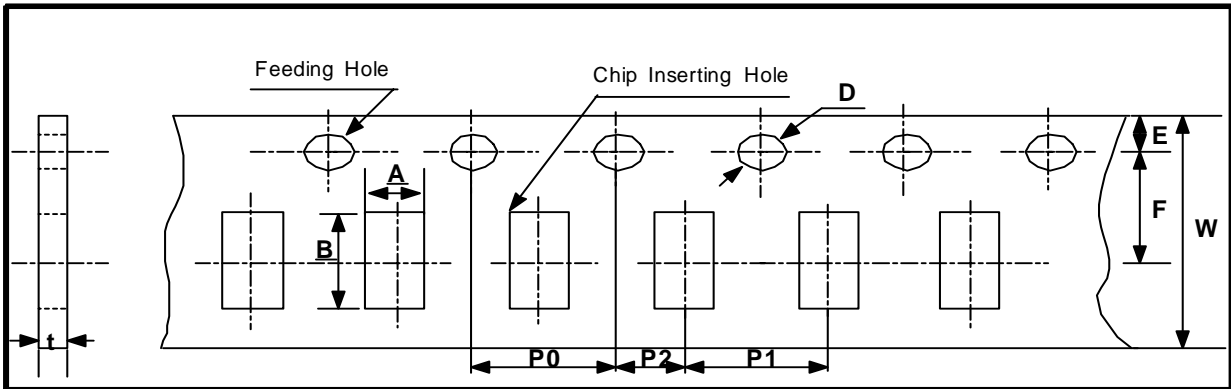

unit : mm

Symbol Type		A	B	W	F	E	P1	P2	P0	D	t
Dimension	0603 (1608)	1.1 ±0.2	1.9 ±0.2	8.0 ±0.3	3.5 ±0.05	1.75 ±0.1	4.0 ±0.1	2.0 ±0.05	4.0 ±0.1	1.5 +0.1/-0	1.1 Below
	0805 (2012)	1.6 ±0.2	2.4 ±0.2								
	1206 (3216)	2.0 ±0.2	3.6 ±0.2								

CARDBOARD PAPER TAPE (2mm)

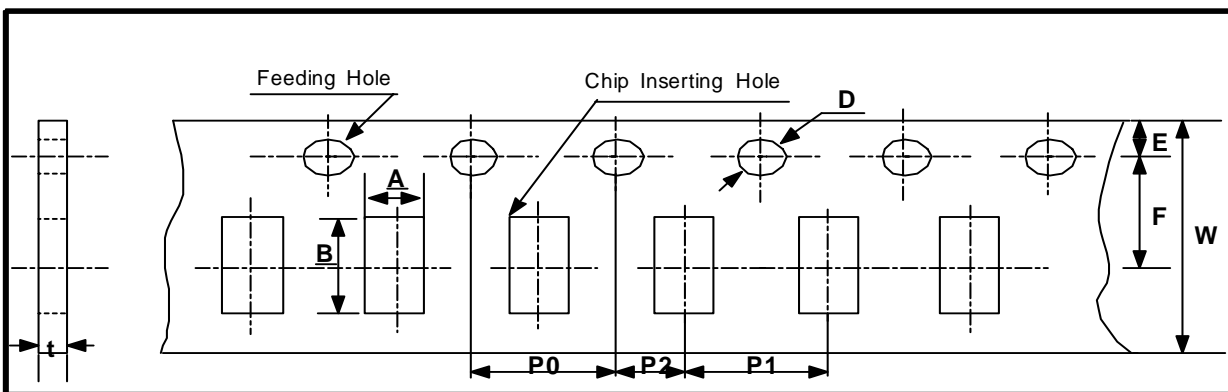

unit : mm

Symbol Type		A	B	W	F	E	P1	P2	P0	D	t
Dimension	0201 (0603)	0.38 ±0.03	0.68 ±0.03	8.0 ±0.3	3.5 ±0.05	1.75 ±0.1	2.0 ±0.05	2.0 ±0.05	4.0 ±0.1	1.5 +0.1/-0.03	0.37 ±0.03
	0402 (1005)	0.62 ±0.04	1.12 ±0.04								0.6 ±0.05

PACKAGING

EMBOSSED PLASTIC TAPE

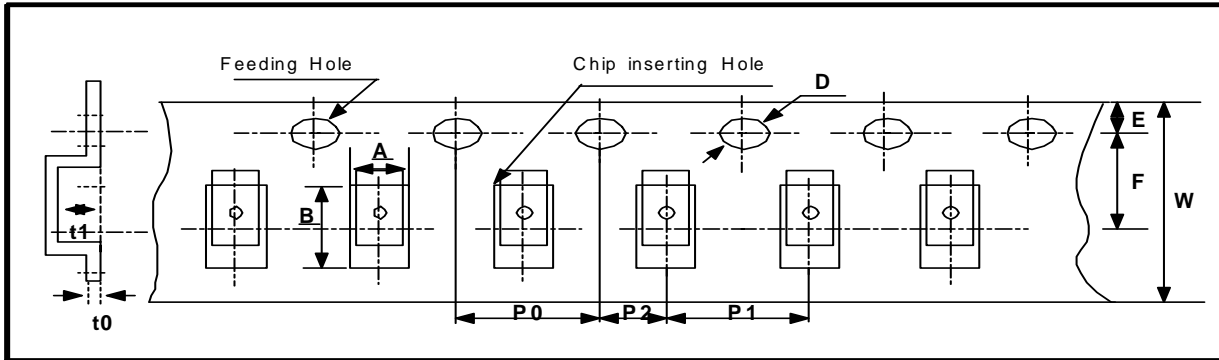

unit : mm

Symbol Type	A	B	W	F	E	P1	P2	P0	D	t1	t0
Dimension	0805 (2012)	1.45 ±0.2	2.3 ±0.2	8.0 ±0.3	3.5 ±0.05	4.0 ±0.1	2.0 ±0.05	4.0 ±0.1	1.5 +0.1/-0	2.5 max	0.6 Below
	1206 (3216)	1.9 ±0.2	3.5 ±0.2								
	1210 (3225)	2.9 ±0.2	3.7 ±0.2								
	1808 (4520)	2.3 ±0.2	4.9 ±0.2	12.0 ±0.3	5.60 ±0.05	8.0 ±0.1	3.8 max				
	1812 (4532)	3.6 ±0.2	4.9 ±0.2								
	2220 (5750)	5.5 ±0.2	6.2 ±0.2								

TAPING SIZE

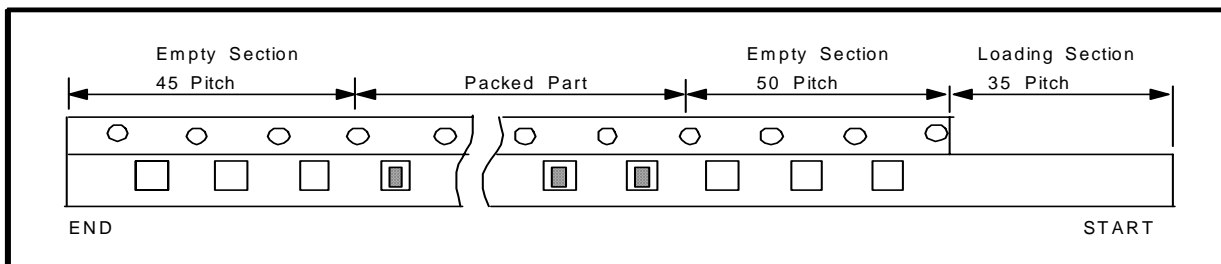

Type	Symbol	Size	Cardboard Paper Tape	Symbol	Size	Embossed Plastic Tape
7" Reel	C	0201(0603)	10,000	E	All Size 3216 1210(3225),1808(4520) (t 1.6mm)	2,000
		0402(1005)	10,000		1210(3225)(t 2.0mm)	1,000
		OTHERS	4,000		1808(4520)(t 2.0mm)	1,000
10" Reel	O	-	10,000	-	-	-
13" Reel	D	0402(1005)	50,000	F	All Size 3216 1210(3225),1808(4520) (t<1.6mm)	10,000
		OTHERS	10,000		1210(3225)(1.6 t<2.0mm) 1206(3216)(1.6 t)	8,000
	L	0603(1608)	10,000 or 15,000		1210(3225),1808(4520) (t 2.0mm)	4,000
		0805(2012) (t 0.85mm)	15,000 or 10,000(Option)		1812(4532)(t 2.0mm)	4,000
		1206(3216) (t 0.85mm)	10,000		1812(4532)(t>2.0mm) 5750(2220)	2,000

PACKAGING

REEL DIMENSION

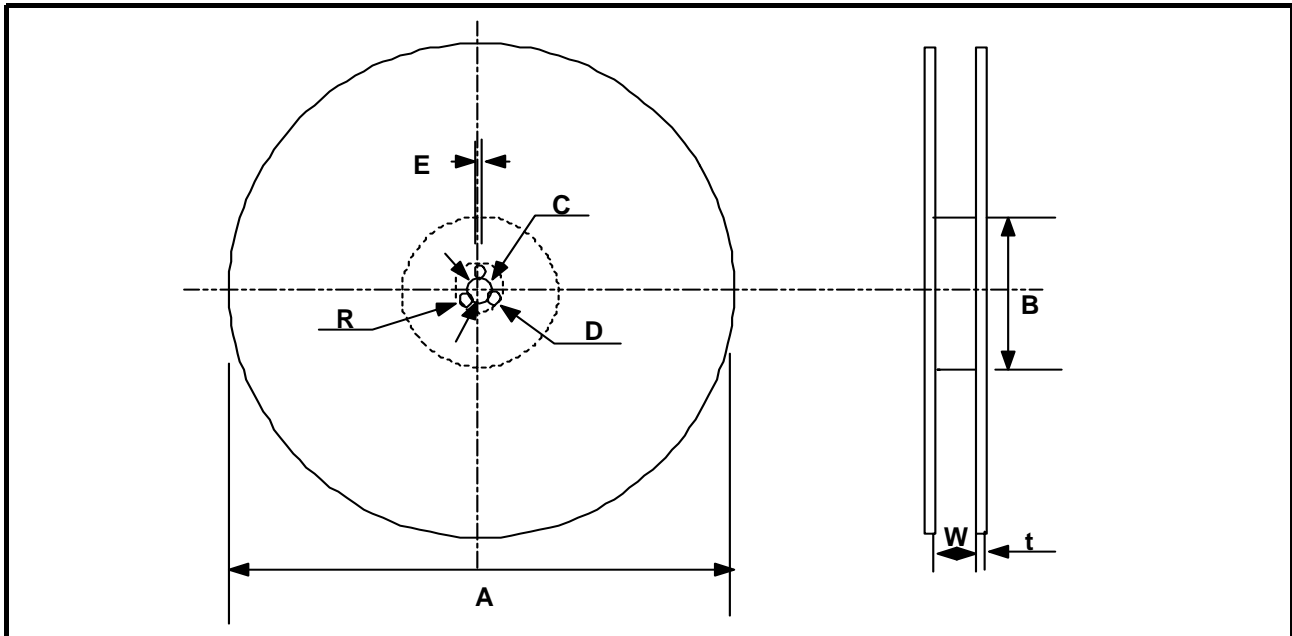

unit : mm

Symbol	A	B	C	D	E	W	t	R
7" Reel	180+0/ -3	60+1/ -3	13±0.3	25±0.5	2.0±0.5	9±1.5	1.2±0.2	1.0
13" Reel	330±2.0	80+1/ -3					2.2±0.2	

BULK CASE PACKAGING

- Bulk case packaging can reduce the stock space and transportation costs.
- The bulk feeding system can increase the productivity.
- It can eliminate the components loss.

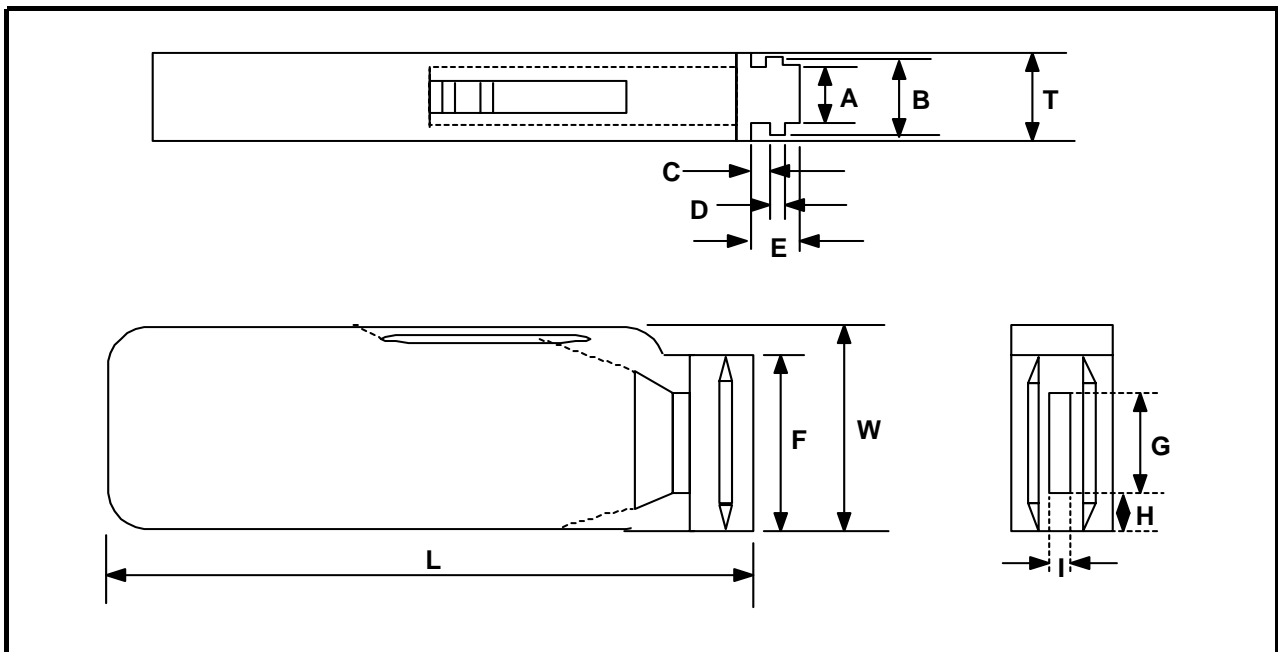

unit : mm

Symbol	A	B	T	C	D	E
Dimension	6.8±0.1	8.8±0.1	12±0.1	1.5+0.1/-0	2+0/-0.1	3.0+0.2/-0

Symbol	F	W	G	H	L	I
Dimension	31.5+0.2/-0	36+0/-0.2	19±0.35	7±0.35	110±0.7	5±0.35

QUANTITY OF BULK CASE PACKAGING

unit : pcs

Size	0402(1005)	0603(1608)	0805(2012)	
			T=0.65mm	T=0.85mm
Quantity	50,000	10,000 or 15,000	10,000	5,000 or 10,000

APPLICATION MANUAL

ELECTRICAL CHARACTERISTICS

CAPACITANCE - TEMPERATURE CHARACTERISTICS

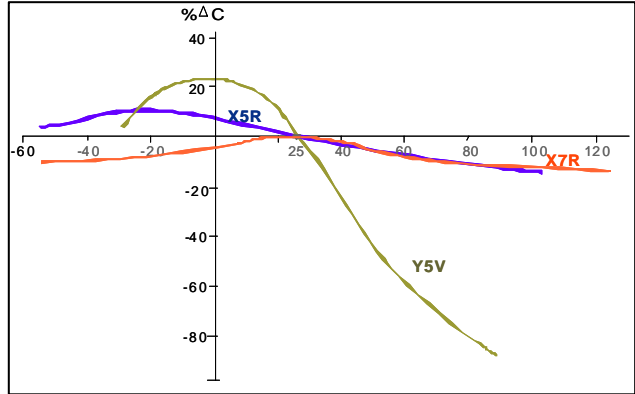
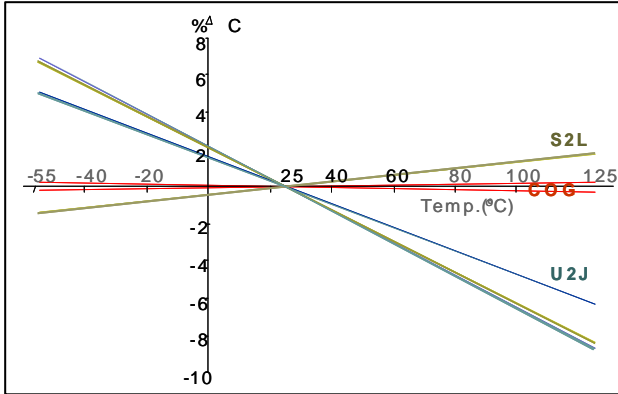

CAPACITANCE - DC VOLTAGE CHARACTERISTICS

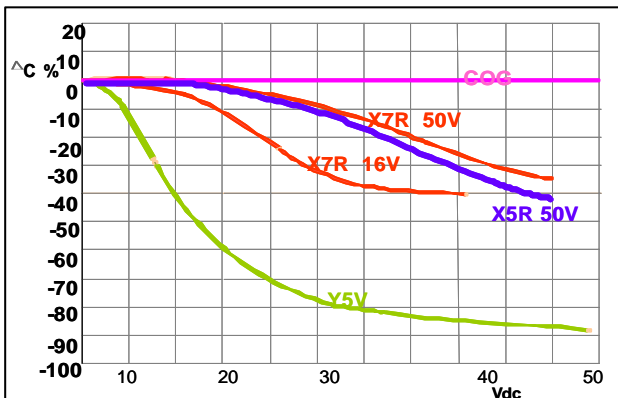

CAPACITANCE CHANGE - AGING

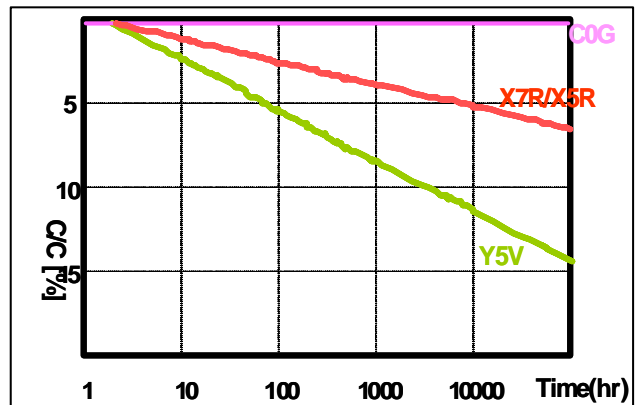

IMPEDANCE - FREQUENCY CHARACTERISTICS

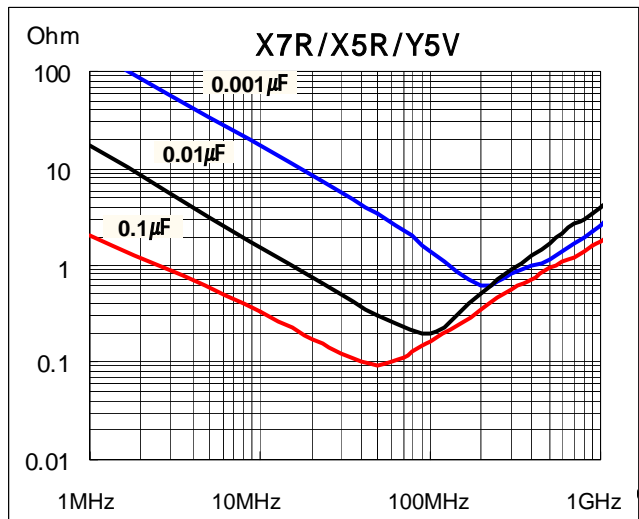
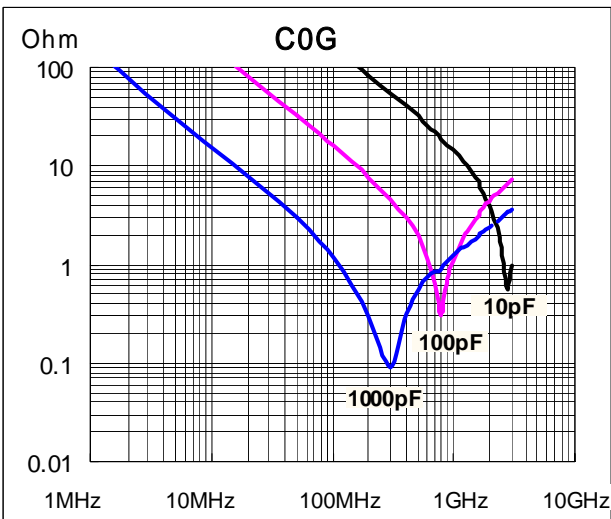

STORAGE CONDITION

Storage Environment

The electrical characteristics of MLCCs were degraded by the environment of high temperature or humidity. Therefore, the MLCCs shall be stored in the ambient temperature and the relative humidity of less than 40% and 70%, respectively.

Guaranteed storage period is within 6 months from the outgoing date of delivery.

Corrosive Gases

Since the solderability of the end termination in MLCC was degraded by a chemical atmosphere such as chlorine, acid or sulfide gases, MLCCs must be avoid from these gases.

Temperature Fluctuations

Since dew condensation may occur by the differences in temperature when the MLCCs are taken out of storage, it is important to maintain the temperature-controlled environment.

DESIGN OF LAND PATTERN

When designing printed circuit boards, the shape and size of the lands must allow for the proper amount of solder on the capacitor.

The amount of solder at the end terminations has a direct effect on the crack.

The crack in MLCC will be easily occurred by the tensile stress which was due to too much amount of solder. In contrast, if too little solder is applied, the termination strength will be insufficiently.

Use the following illustrations as guidelines for proper land design.

Recommendation of Land Shape and Size.

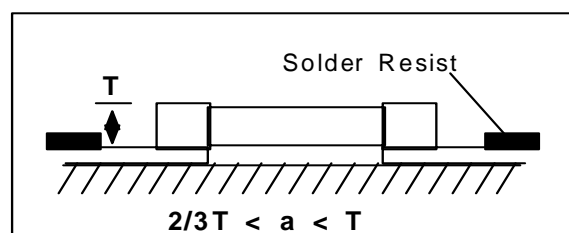
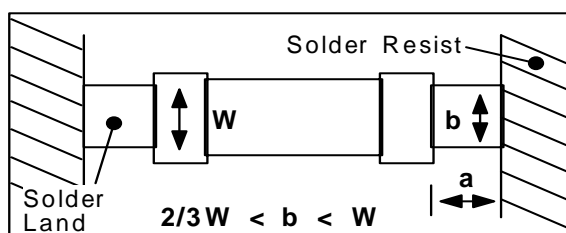

ADHESIVES

When flow soldering the MLCCs, apply the adhesive in accordance with the following conditions.

Requirements for Adhesives

They must have enough adhesion, so that, the chips will not fall off or move during the handling of the circuit board.

They must maintain their adhesive strength when exposed to soldering temperature.

They should not spread or run when applied to the circuit board.

They should harden quickly. They should not corrode the circuit board or chip material.

They should be a good insulator. They should be non-toxic, and not produce harmful gases, nor be harmful when touched.

Application Method

It is important to use the proper amount of adhesive. Too little and much adhesive will cause poor adhesion and overflow into the land, respectively.

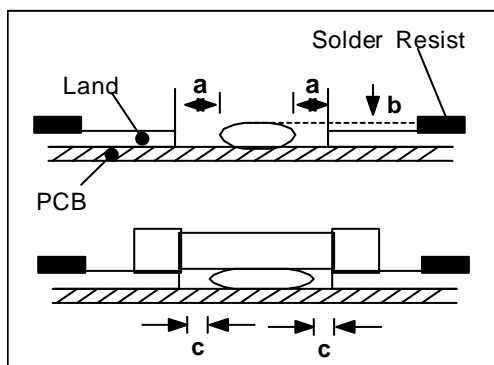

unit : mm

Type	21	31
a	0.2 min	0.2 min
b	70~100 μm	70~100 μm
c	> 0	> 0

Adhesive hardening Characteristics

To prevent oxidation of the terminations, the adhesive must harden at 160 or less, within 2 minutes or less.

MOUNTING

Mounting Head Pressure

Excessive pressure will cause crack to MLCCs. The pressure of nozzle will be 300g maximum during mounting.

Bending Stress

When double-sided circuit boards are used, MLCCs first are mounted and soldered onto one side of the board. When the MLCCs are mounted onto the other side, it is important to support the board as shown in the illustration. If the circuit board is not supported, the crack occur to the ready-installed MLCCs by the bending stress.

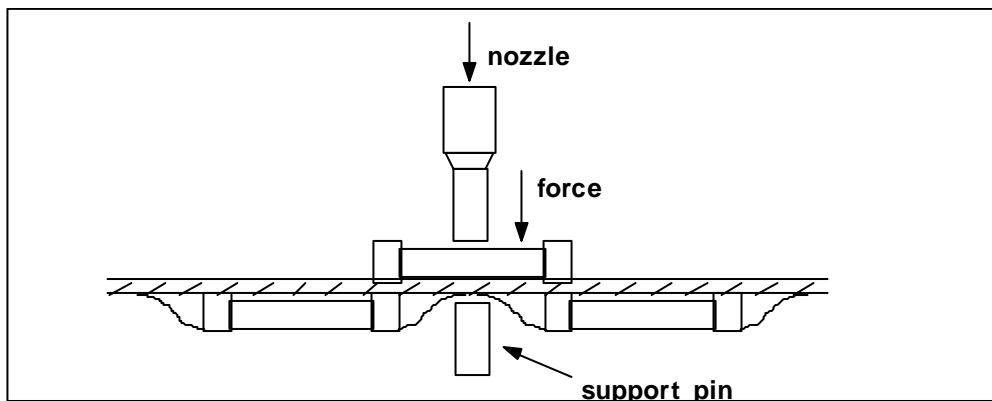

Manual Soldering

Manual soldering can pose a great risk of creating thermal cracks in chip capacitors.

The hot soldering iron tip comes into direct contact with the end terminations, and operator's carelessness may cause the tip of the soldering iron to come into direct contact with the ceramic body of the capacitor.

Therefore the soldering iron must be handled carefully, and close attention must be paid to the selection of the soldering iron tip and to temperature control of the tip.

Amount of Solder

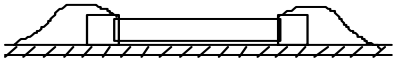
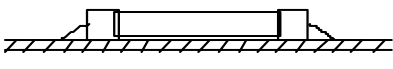
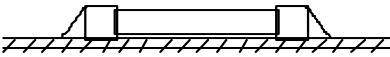
Too much Solder		Cracks tend to occur due to large stress
Not enough Solder		Weak holding force may cause bad connections or detaching of the capacitor
Good		

Cooling

Natural cooling using air is recommended. If the chips are dipped into solvent for cleaning, the temperature difference (ΔT) must be less than 100

Cleaning

If rosin flux is used, cleaning usually is unnecessary. When strongly activated flux is used, chlorine in the flux may dissolve into some types of cleaning fluids, thereby affecting the chip capacitors. This means that the cleaning fluid must be carefully selected, and should always be new.

Notes for Separating Multiple, Shared PC Boards.

A multi-PC board is separated into many individual circuit boards after soldering has been completed. If the board is bent or distorted at the time of separation, cracks may occur in the chip capacitors. Carefully choose a separation method that minimizes the bending of the circuit board.

Recommended Soldering Profile

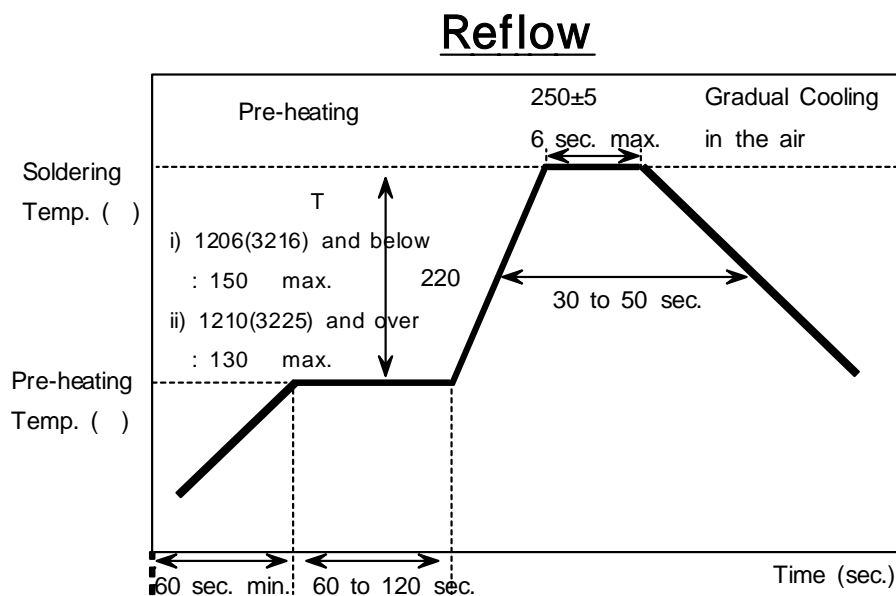

Flow

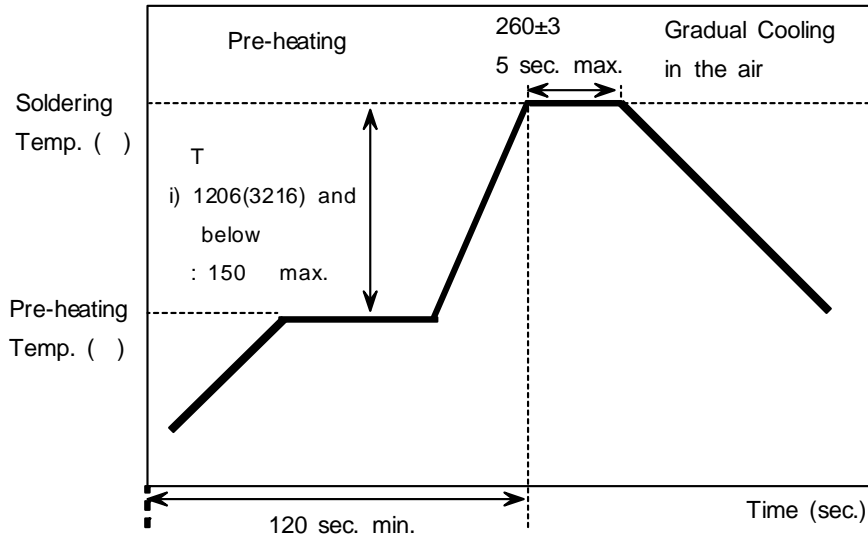

Soldering Iron

Variation of Temp.	Soldering Temp ()	Pre-heating Time (Sec)	Soldering Time(Sec)	Cooling Time(Sec)
T 130	300±10 max	60	4	-

Condition of Iron facilities		
Wattage	Tip Diameter	Soldering Time
20W Max	3mm Max	4 Sec Max

*** Caution - Iron Tip Should Not Contact With Ceramic Body Directly.**