

# DATA SHEET

SURFACE MOUNT MULTILAYER  
CERAMIC CAPACITORS

General purpose & High capacitance

Class 2, X5R

4 V TO 50 V

100 pF to 100  $\mu$ F

RoHS compliant & Halogen free



SCOPE

This specification describes X5R series chip capacitors with lead-free terminations.

APPLICATIONS

- PCs, Hard disk, Game PCs
- Power supplies
- DVD players
- Mobile phones
- Data processing

FEATURES

- Supplied in tape on reel
- Nickel-barrier end termination
- RoHS compliant
- Halogen free compliant

ORDERING INFORMATION-GLOBAL PART NUMBER, PHYCOMP

CTC & I2NC

All part numbers are identified by the series, size, tolerance, TC material, packing style, voltage, process code, termination and capacitance value.

**YAGEO BRAND ordering code**

**GLOBAL PART NUMBER (PREFERRED)**

**CC** xxxx x x **X5R** x **BB** xxx  
 (1) (2) (3) (4) (5)

**(1) SIZE – INCH BASED (METRIC)**

- 0201 (0603)
- 0402 (1005)
- 0603 (1608)
- 0805 (2012)
- 1206 (3216)
- 1210 (3225)
- 1812 (4532)

**(2) TOLERANCE**

- K = ±10%
- M = ±20%

**(3) PACKING STYLE**

- R = Paper/PE taping reel; Reel 7 inch
- K = Blister taping reel; Reel 7 inch
- P = Paper/PE taping reel; Reel 13 inch
- F = Blister taping reel; Reel 13 inch
- C = Bulk case

**(4) RATED VOLTAGE**

- 4 = 4 V
- 5 = 6.3 V
- 6 = 10 V
- 7 = 16 V
- 8 = 25 V
- 9 = 50 V

**(5) CAPACITANCE VALUE**

2 significant digits+number of zeros  
 The 3rd digit signifies the multiplying factor, and letter R is decimal point  
 Example: 103 = 10 × 10<sup>3</sup> = 10,000 pF = 10 nF

**PHYCOMP BRAND ordering codes**

GLOBAL PART NUMBER (preferred), PHYCOMP CTC (for North America) and I2NC (traditional) codes are acceptable to order Phycomp brand products.

**GLOBAL PART NUMBER (PREFERRED)**

For detailed information of GLOBAL PART NUMBER and ordering example, please refer to page 2.

**I2NC CODE**

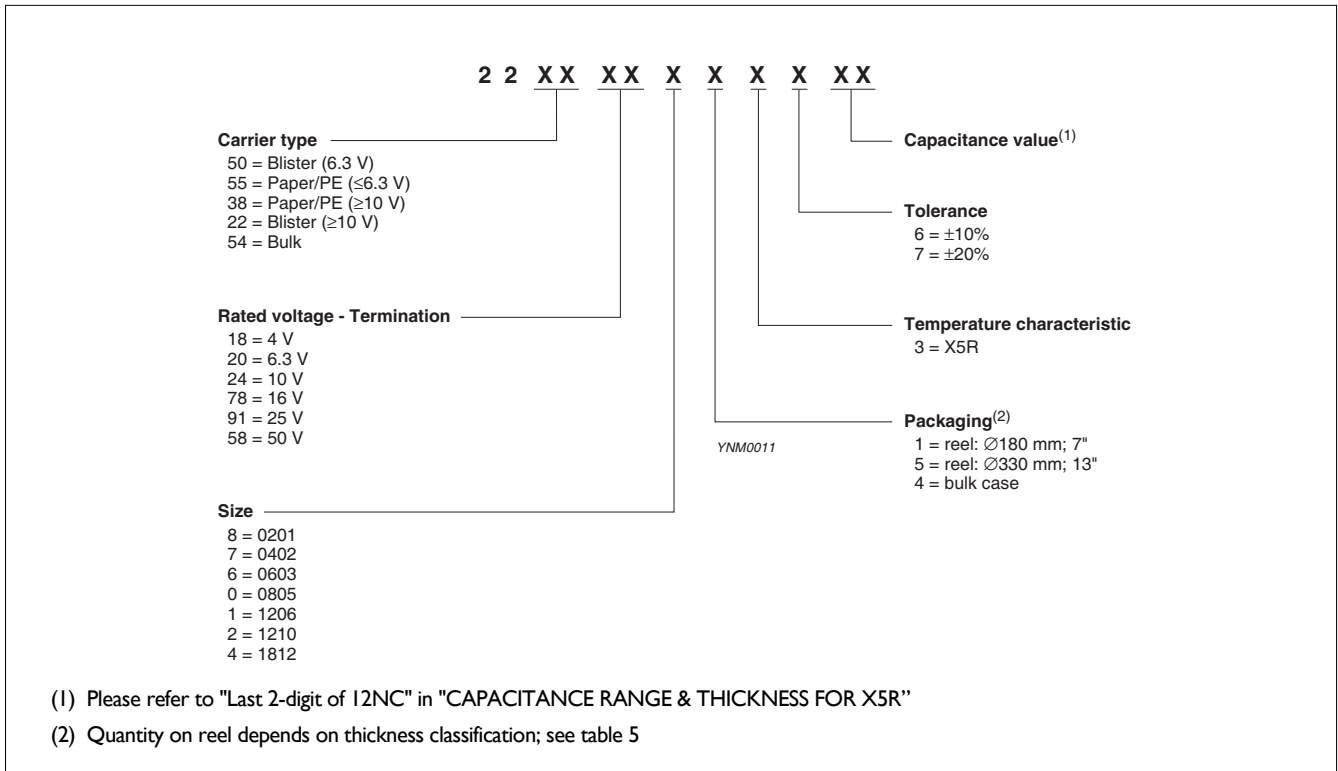

**PHYCOMP CTC CODE (FOR NORTH AMERICA)**

Example: 06032B225M5B20D

0603	2B	225	M	5	B	2	0	D
Size code	Temp. Char.	Capacitance in pF	Tolerance	Voltage	Termination	Packing	Marking	Range identifier
0201	2B = X5R	101 = 100 pF; the third digit signifies the multiplying factor:	K = $\pm 10\%$ M = $\pm 20\%$	4 = 4 V 5 = 6.3 V 6 = 10 V 7 = 16 V 8 = 25 V 9 = 50 V	B = NiSn	2 = 180 mm 7" Paper/PE 3 = 330 mm 13" Paper/PE	0 = no marking	D = Class 2 MLCC
0402								
0603								
0805		0 = $\times 1$				B = 180 mm		
1206		1 = $\times 10$				7" Blister		
1210		2 = $\times 100$				F = 330 mm		
1812		3 = $\times 1,000$ 4 = $\times 10,000$ 5 = $\times 100,000$ 6 = $\times 1,000,000$ 7 = $\times 10,000,000$				13" Blister P = Bulk case		

**CONSTRUCTION**

The capacitor consists of a rectangular block of ceramic dielectric in which a number of interleaved metal electrodes are contained. This structure gives rise to a high capacitance per unit volume.

The inner electrodes are connected to the two end terminations and finally covered with a layer of plated tin (NiSn). The terminations are lead-free. A cross section of the structure is shown in Fig.1.

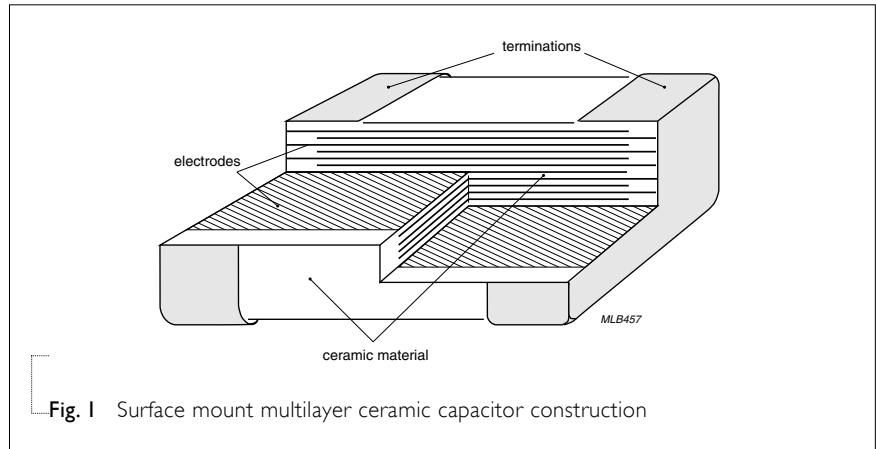

**DIMENSION**

Table I For outlines see fig. 2

TYPE	L <sub>1</sub> (mm)	W (mm)	T (MM)	L <sub>2</sub> / L <sub>3</sub> (mm)		L <sub>4</sub> (mm)
				min.	max.	min.
0201	0.6 ±0.03 <sup>(1)</sup>	0.3 ±0.03 <sup>(1)</sup>	Refer to table 2 to 4	0.10	0.20	0.20
	0.6 ±0.05 <sup>(2)</sup>	0.3 ±0.05 <sup>(2)</sup>				
0402	1.0 ±0.05 <sup>(1)</sup>	0.5 ±0.05 <sup>(1)</sup>		0.20	0.30	0.40
	1.0 ±0.20 <sup>(3)</sup>	0.5 ±0.20 <sup>(3)</sup>				
0603	1.6 ±0.10 <sup>(1)</sup>	0.8 ±0.10 <sup>(1)</sup>		0.20	0.60	0.40
	1.6 ±0.15 <sup>(2)</sup>	0.8 ±0.15 <sup>(2)</sup>				
0805	1.6 ±0.20 <sup>(3)</sup>	0.8 ±0.20 <sup>(3)</sup>		0.25	0.75	0.55
	2.0 ±0.10 <sup>(1)</sup>	1.25 ±0.10 <sup>(1)</sup>				
1206	2.0 ±0.20 <sup>(2)</sup>	1.25 ±0.20 <sup>(2)</sup>		0.25	0.75	1.40
	3.2 ±0.15 <sup>(1)</sup>	1.6 ±0.15 <sup>(1)</sup>				
1210	3.2 ±0.30 <sup>(2)</sup>	1.6 ±0.20 <sup>(2)</sup>		0.25	0.75	1.40
	3.2 ±0.30 <sup>(3)</sup>	1.6 ±0.30 <sup>(2)</sup>				
1812	3.2 ±0.20 <sup>(1)</sup>	2.5 ±0.20 <sup>(1)</sup>	0.25	0.75	2.20	
	3.2 ±0.40 <sup>(2)</sup>	2.5 ±0.30 <sup>(2)</sup>				
	4.5 ±0.20 <sup>(1)</sup>	3.2 ±0.20 <sup>(1)</sup>				
	4.5 ±0.40 <sup>(2)</sup>	3.2 ±0.40 <sup>(2)</sup>				

**NOTE**

1. Dimensions for size 0201, C < 1 μF; 0402, C < 4.7 μF; 0603, C < 4.7 μF; 0805 to 1812, C ≤ 100nF
2. Dimensions for size 0201, C ≥ 1 μF; 0402, C ≥ 4.7 μF; 0603, 10 μF > C ≥ 4.7 μF; 0805 to 1812, C > 100 nF
3. Dimensions for size 0402, C ≥ 10 μF; 0603, C ≥ 10 μF; 1206, C ≥ 100 μF

**OUTLINES**

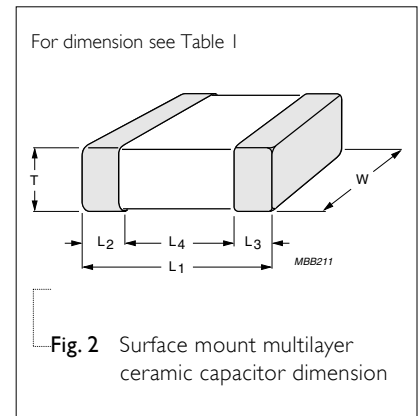

Fig. 2 Surface mount multilayer ceramic capacitor dimension

**CAPACITANCE RANGE & THICKNESS FOR X5R**

**Table 2** Sizes from 0201 to 0402

CAP.	Last 2-digit of 12NC	0201					0402						
		4 V	6.3 V	10 V	16 V	25 V	50 V	4 V	6.3 V	10 V	16 V	25 V	50 V
100 pF	09												
150 pF	12												
220 pF	14												
330 pF	16						0.3±0.03						
470 pF	18												
680 pF	21												
1.0 nF	23					0.3±0.03							
1.5 nF	25												
2.2 nF	27												
3.3 nF	29		0.3±0.03	0.3±0.03	0.3±0.03								
4.7 nF	32												
6.8 nF	34												
10 nF	36												
15 nF	39												
22 nF	41												
33 nF	43												
47 nF	45												
68 nF	47										0.5±0.05	0.5±0.05	0.5±0.05
100 nF	49												
150 nF	52												
220 nF	54	0.3±0.03	0.3±0.03	0.3±0.03				0.5±0.05	0.5±0.05				
330 nF	56												
470 nF	58	0.3±0.03	0.3±0.03								0.5±0.05	0.5±0.05	0.5±0.05
680 nF	61												
1.0 µF	63	0.3±0.05	0.3±0.05								0.5±0.05	0.5±0.05	
2.2 µF	67												
4.7 µF	72							0.5±0.15	0.5±0.15				
10 µF	76							0.5±0.20	0.5±0.20				

**NOTE**

1. Values in shaded cells indicate thickness class in mm
2. Capacitance value of non E-6 series is available on request

**CAPACITANCE RANGE & THICKNESS FOR X5R**

**Table 3** Sizes from 0603 to 0805

CAP.	Last 2-digit of	0603				0805				
		12NC	6.3 V	10 V	16 V	25 V	6.3 V	10 V	16 V	25 V
10 nF	36									
15 nF	38									
22 nF	41									
33 nF	43									
47nF	45									
68 nF	47									
100 nF	49									
150 nF	52									
220 nF	54									
330 nF	56									
470 nF	58									
680 nF	61	0.8±0.1	0.8±0.1	0.8±0.1	0.8±0.1			0.85±0.1 1.25±0.2	1.25±0.2	1.25±0.2
1.0 µF	63					0.85±0.1 1.25±0.2	0.85±0.1 1.25±0.2			0.85±0.1 1.25±0.2
2.2 µF	67									0.85±0.1 1.25±0.2
4.7 µF	72			0.8±0.15						1.25±0.2
10 µF	76		0.8±0.2					1.25±0.2		1.25±0.2
22 µF	81	0.8±0.2					1.25±0.2			
47 µF	85					1.25±0.2				
100 µF	89									

**NOTE**

1. Values in shaded cells indicate thickness class in mm
2. Capacitance value of non E-6 series is available on request

**CAPACITANCE RANGE & THICKNESS FOR X5R**

**Table 4** Sizes from 1206 to 1812

CAP.	Last 2-digit of	1206				1210				1812
		12NC	6.3 V	10 V	16 V	25 V	6.3 V	10 V	16 V	25 V
10 nF	36									
15 nF	38									
22 nF	41									
33 nF	43									
47nF	45									
68 nF	47									
100 nF	49									
150 nF	52									
220 nF	54									
330 nF	56									
470 nF	58									
680 nF	61									
1.0 μF	63									
2.2 μF	67	1.15±0.1	1.15±0.1	1.15±0.1	1.15±0.1					
4.7 μF	72									
10 μF	76	1.6±0.2	1.6±0.2	1.6±0.2	1.6±0.2	1.9±0.2	1.9±0.2	1.9±0.2	1.9±0.2	
22 μF	81						2.5±0.2	2.5±0.2	2.5±0.3	
47 μF	85					2.5±0.2				2.5±0.2
100 μF	89	1.6±0.3								3.2±0.3

**NOTE**

1. Values in shaded cells indicate thickness class in mm
2. Capacitance value of non E-6 series is available on request

**THICKNESS CLASSES AND PACKING QUANTITY**

Table 5

SIZE CODE	THICKNESS CLASSIFICATION	TAPE WIDTH QUANTITY PER REEL	Ø180 MM / 7 INCH		Ø330 MM / 13 INCH		QUANTITY PER BULK CASE
			Paper	Blister	Paper	Blister	
0201	0.3 ±0.03 mm	8 mm	15,000	---	50,000	---	---
0402	0.5 ±0.05 mm	8 mm	10,000	---	50,000	---	50,000
0603	0.8 ±0.1 mm	8 mm	4,000	---	15,000	---	15,000
0805	0.6 ±0.1 mm	8 mm	4,000	---	20,000	---	10,000
	0.85 ±0.1 mm	8 mm	4,000	---	15,000	---	8,000
	1.25 ±0.2 mm	8 mm	---	3,000	---	10,000	5,000
1206	0.6 ±0.1 mm	8 mm	4,000	---	20,000	---	---
	0.85 ±0.1 mm	8 mm	4,000	---	15,000	---	---
	1.00 / 1.15 ±0.1 mm	8 mm	---	3,000	---	10,000	---
	1.25 ±0.2 mm	8 mm	---	3,000	---	10,000	---
	1.6 ±0.15 mm	8 mm	---	2,500	---	10,000	---
1210	1.6 ±0.2 mm	8 mm	---	2,000	---	10,000	---
	0.6 / 0.7 ±0.1 mm	8 mm	---	4,000	---	15,000	---
	0.85 ±0.1 mm	8 mm	---	4,000	---	10,000	---
	1.15 ±0.1 mm	8 mm	---	3,000	---	10,000	---
	1.15 ±0.15 mm	8 mm	---	3,000	---	10,000	---
	1.25 ±0.2 mm	8 mm	---	3,000	---	---	---
	1.5 ±0.1 mm	8 mm	---	2,000	---	---	---
	1.6 / 1.9 ±0.2 mm	8 mm	---	2,000	---	---	---
1808	2.0 ±0.2 mm	8 mm	---	2,000 1,000	---	---	---
	2.5 ±0.2 mm	8 mm	---	1,000 500	---	---	---
	1.15 ±0.15 mm	12 mm	---	3,000	---	---	---
	1.25 ±0.2 mm	12 mm	---	3,000	---	---	---
	1.35 ±0.15 mm	12 mm	---	2,000	---	---	---
	1.5 ±0.1 mm	12 mm	---	2,000	---	---	---
	1.6 ±0.2 mm	12 mm	---	2,000	---	---	---
1812	2.0 ±0.2 mm	12 mm	---	2,000	---	---	---
	0.6 / 0.85 ±0.1 mm	12 mm	---	2,000	---	---	---
	1.15 ±0.1 mm	12 mm	---	1,000	---	---	---
	1.25 ±0.2 mm	12 mm	---	1,000	---	---	---
	1.5 ±0.1 mm	12 mm	---	1,000	---	---	---
	1.6 ±0.2 mm	12 mm	---	1,000	---	---	---
	2.0 ±0.2 mm	12 mm	---	1,000	---	---	---
2.5 ±0.2 mm	12 mm	---	500	---	---	---	



ELECTRICAL CHARACTERISTICS

**X5R DIELECTRIC CAPACITORS; NISN TERMINATIONS**

Unless otherwise specified, all tests and measurements shall be made under standard atmospheric conditions for testing as given in 5.3 of IEC 60068-1:

- Temperature: 15 °C to 35 °C
- Relative humidity: 25% to 75%
- Air pressure: 86 kPa to 106 kPa

Before the measurements are made, the capacitor shall be stored at the measuring temperature for a time sufficient to allow the entire capacitor to reach this temperature.

The period as prescribed for recovery at the end of a test is normally sufficient for this purpose.

Table 6

DESCRIPTION	VALUE
Capacitance range	10 nF to 100 µF
Capacitance tolerance	±10% and ±20%
Dissipation factor (D.F.)	
6.3 V	≤ 5%
Exception: 0402 ≥ 180 nF; 1210 ≥ 22 µF	≤ 7%
0201 ≥ 12 nF; 0402 ≥ 330 nF; 0603 ≥ 2.2 µF; 0805 ≥ 1 µF; 1206 ≥ 22 µF; 1210 ≥ 100 µF	≤ 10%
1206 ≥ 100 µF	≤ 15%
10 V	≤ 5%
Exception: 0402 ≥ 180 nF; 0805 ≥ 1 µF; 1206 ≥ 6.8 µF	≤ 7%
0201 ≥ 100 nF; 0402 ≥ 330 nF; 0603 ≥ 1 µF; 0805 ≥ 2.2 µF; 1206 ≥ 10 µF; 1210 ≥ 10 µF	≤ 10%
16 V	≤ 5%
Exception: 0402 ≥ 180 nF; 0603 ≥ 680 nF; 0805 ≥ 1 µF	≤ 7%
0402 ≥ 330 nF; 0603 ≥ 2.2 µF; 0805 ≥ 10 µF 1206 ≥ 10 µF; 1210 ≥ 10 µF	≤ 10%
≥ 25 V	≤ 3.5%
Exception: 0402 ≥ 27 nF; 0603 ≥ 220 nF; 0805 ≥ 2.2 µF; 1206 ≥ 4.7 µF; 1210 ≥ 10 µF	≤ 5%
0402 ≥ 180 nF	≤ 7%
0402 ≥ 470 nF; 1206 ≥ 10 µF 0805 ≥ 4.7 µF	≤ 10%
Insulation resistance after 1 minute at $U_r$ (DC)	$R_{ins} \geq 10 \text{ G}\Omega$ or $R_{ins} \times C_r \geq 500$ seconds whichever is less
Maximum capacitance change as a function of temperature (temperature characteristic/coefficient):	±15%
Operating temperature range:	-55 °C to +85 °C

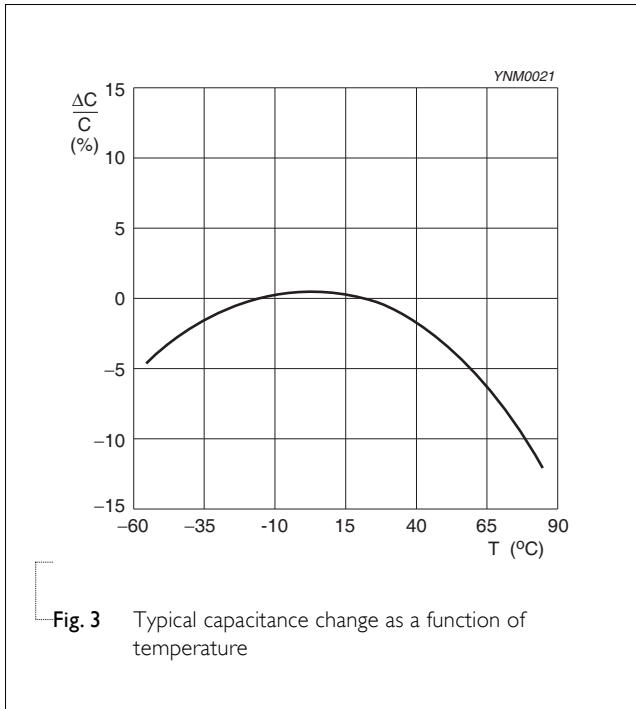

Size 0201 10 nF / 16 V  
Solid lines: Impedance / Dotted lines: ESR

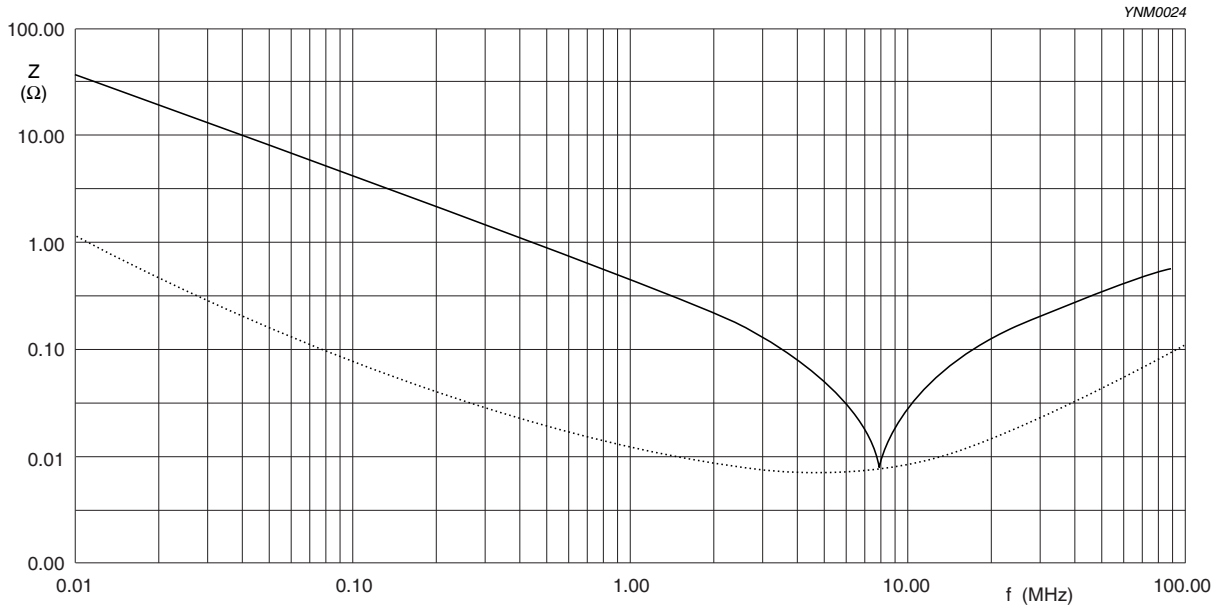

**Fig. 4** Impedance ESR vs. frequency characteristics for multilayer chip capacitors

Size 0603 1 μF / 10 V  
Solid lines: Impedance / Dotted lines: ESR

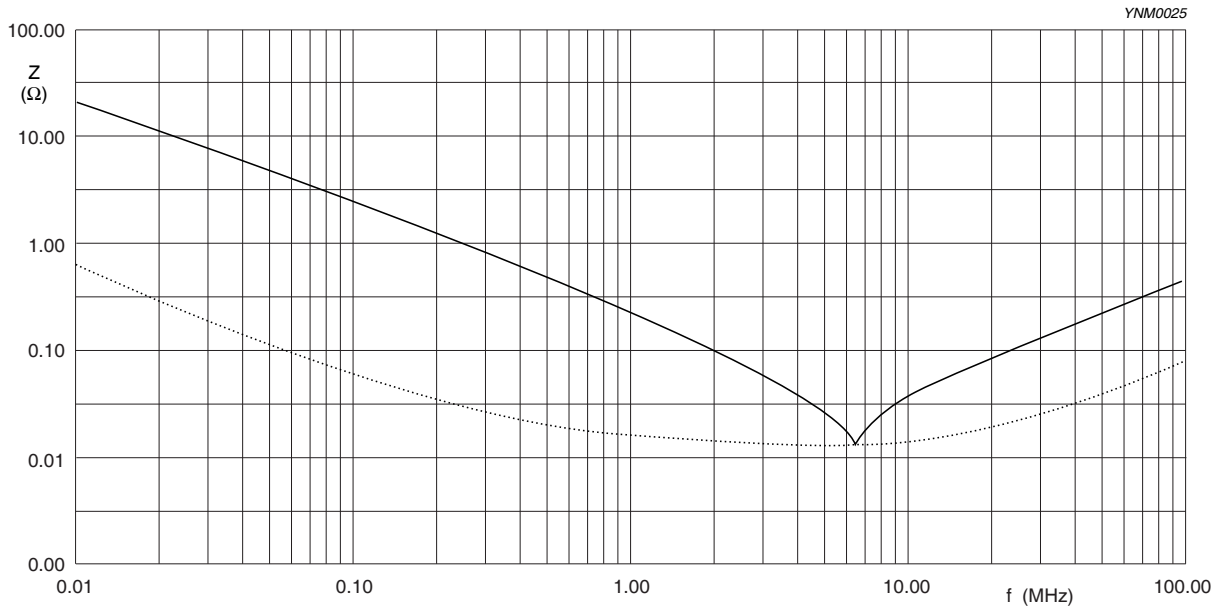

**Fig. 5** Impedance ESR vs. frequency characteristics for multilayer chip capacitors

Size 0805 10  $\mu$ F / 6.3 V  
Solid lines: Impedance / Dotted lines: ESR

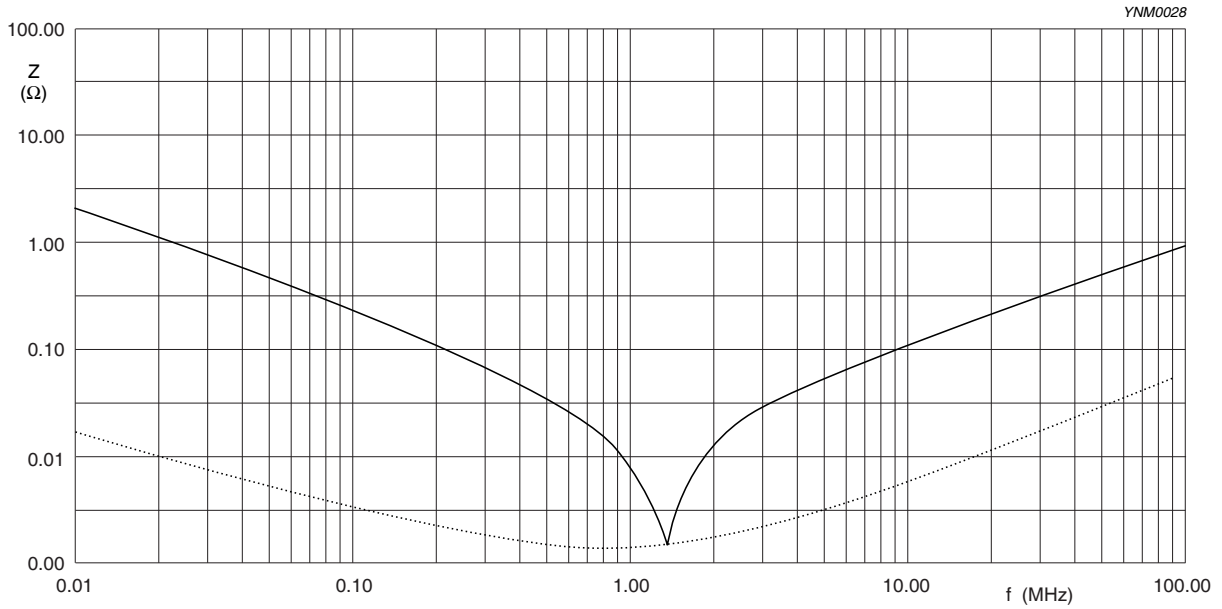

**Fig. 6** Impedance ESR vs. frequency characteristics for multilayer chip capacitors

Size 1206 10  $\mu$ F / 16 V  
Solid lines: Impedance / Dotted lines: ESR

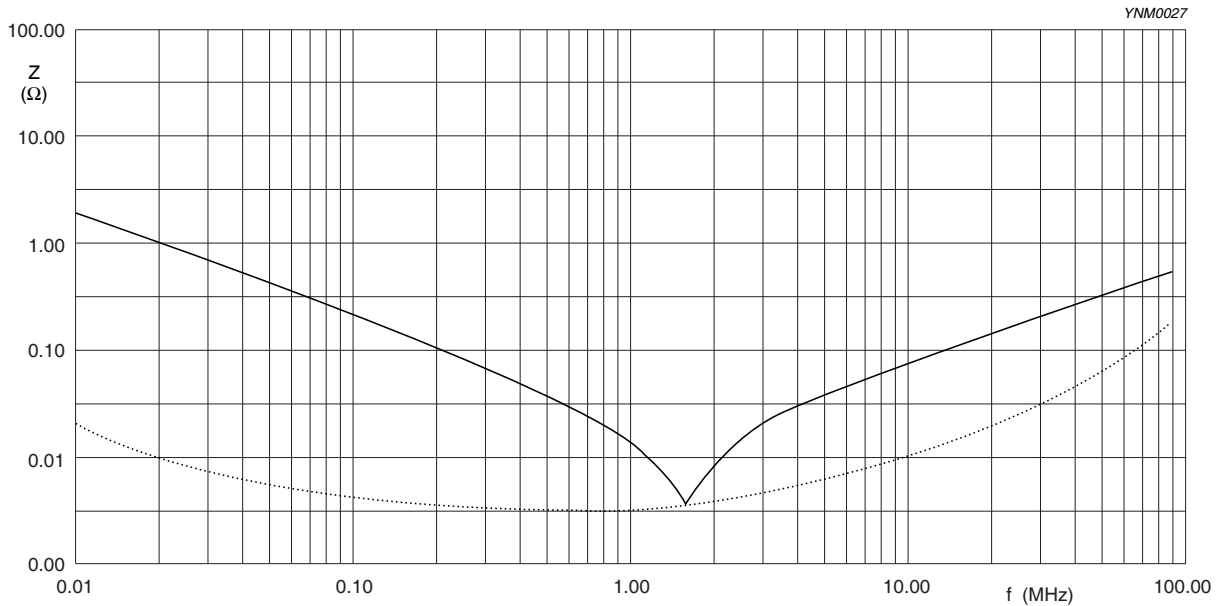

**Fig. 7** Impedance ESR vs. frequency characteristics for multilayer chip capacitors

Size 1210 10  $\mu$ F / 25 V  
Solid lines: Impedance / Dotted lines: ESR

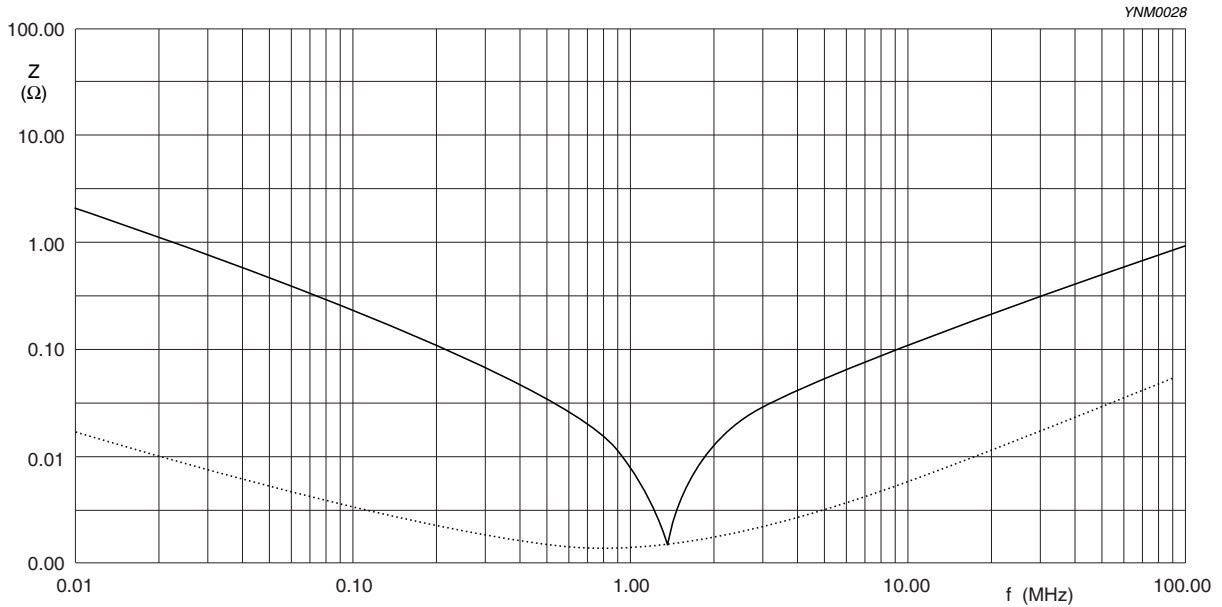

**Fig. 8** Impedance ESR vs. frequency characteristics for multilayer chip capacitors

**SOLDERING RECOMMENDATION**

Table 7

SOLDERING METHOD	SIZE 0402	0603	0805	1206	≥ 1210
Reflow	≥ 0.1 $\mu$ F	≥ 1.0 $\mu$ F	≥ 2.2 $\mu$ F	≥ 4.7 $\mu$ F	Reflow only
Reflow/Wave	< 0.1 $\mu$ F	< 1.0 $\mu$ F	< 2.2 $\mu$ F	< 4.7 $\mu$ F	---

**TESTS AND REQUIREMENTS**
**Table 8** Test procedures and requirements

TEST	TEST METHOD	PROCEDURE	REQUIREMENTS
Mounting	IEC 60384-21/22 4.3	The capacitors may be mounted on printed-circuit boards or ceramic substrates	No visible damage
Visual Inspection and Dimension Check	4.4	Any applicable method using $\times 10$ magnification	In accordance with specification
Capacitance <sup>(1)</sup>	4.5.1	Class 2: At 20 °C, 24 hrs after annealing f = 1 KHz for C ≤ 10 μF, rated voltage > 6.3 V, measuring at voltage 1 V <sub>rms</sub> at 20 °C f = 1 KHz, for C ≤ 10 μF, rated voltage ≤ 6.3 V, measuring at voltage 0.5 V <sub>rms</sub> at 20 °C f = 120 Hz for C > 10 μF, measuring at voltage 0.5 V <sub>rms</sub> at 20 °C	Within specified tolerance
Dissipation Factor (D.F.) <sup>(1)</sup>	4.5.2	Class 2: At 20 °C, 24 hrs after annealing f = 1 KHz for C ≤ 10 μF, rated voltage > 6.3 V, measuring at voltage 1 V <sub>rms</sub> at 20 °C f = 1 KHz, for C ≤ 10 μF, rated voltage ≤ 6.3 V, measuring at voltage 0.5 V <sub>rms</sub> at 20 °C f = 120 Hz for C > 10 μF, measuring at voltage 0.5 V <sub>rms</sub> at 20 °C	In accordance with specification
Insulation Resistance	4.5.3	At U <sub>r</sub> (DC) for 1 minute	In accordance with specification
Temperature Characteristic	4.6	Class 2: Between minimum and maximum temperature X5R: -55 °C to +85 °C Normal Temperature: 20 °C	<General purpose series> ΔC/C Class 2: X5R: ±15%  <High Capacitance series> ΔC/C Class 2: X5R: ±15%
Adhesion	4.7	A force applied for 10 seconds to the line joining the terminations and in a plane parallel to the substrate	Force size ≥ 0603: 5N size = 0402: 2.5N size = 0201: 1N

**NOTE**

1. The figure indicates typical inspection. Please refer to individual specifications.

TEST	TEST METHOD	PROCEDURE	REQUIREMENTS
Bond Strength of Plating on End Face	IEC 60384-21/22	4.8 Mounting in accordance with IEC 60384-22 paragraph 4.3	No visible damage
		Conditions: bending 1 mm at a rate of 1 mm/s, radius jig 340 mm	<p>&lt;General purpose series&gt;</p> <p><math>\Delta C/C</math></p> <p>Class2:</p> <p>X5R: <math>\pm 10\%</math></p> <p>&lt;High Capacitance series&gt;</p> <p><math>\Delta C/C</math></p> <p>Class2:</p> <p>X5R: <math>\pm 10\%</math></p>
Resistance to Soldering Heat	4.9	Precondition: 150 $\pm 10$ °C for 1 hour, then keep for 24 $\pm 1$ hours at room temperature	Dissolution of the end face plating shall not exceed 25% of the length of the edge concerned
		Preheating: for size $\leq 1206$ : 120 °C to 150 °C for 1 minute Preheating: for size $>1206$ : 100 °C to 120 °C for 1 minute and 170 °C to 200 °C for 1 minute Solder bath temperature: 260 $\pm 5$ °C Dipping time: 10 $\pm 0.5$ seconds Recovery time: 24 $\pm 2$ hours	
			<p>&lt;General purpose series&gt;</p> <p><math>\Delta C/C</math></p> <p>Class2:</p> <p>X5R: <math>\pm 10\%</math></p> <p>&lt;High Capacitance series&gt;</p> <p><math>\Delta C/C</math></p> <p>Class2:</p> <p>X5R: <math>\pm 10\%</math></p>
			D.F. within initial specified value R <sub>ins</sub> within initial specified value
Solderability	4.10	Preheated the temperature of 80 °C to 140 °C and maintained for 30 seconds to 60 seconds.	The solder should cover over 95% of the critical area of each termination
		Test conditions for lead-free containing solder alloy Temperature: 235 $\pm 5$ °C Dipping time: 2 $\pm 0.2$ seconds Depth of immersion: 10 mm Alloy Composition: 60/40 Sn/Pb Number of immersions: 1  Test conditions for lead-free containing solder alloy Temperature: 245 $\pm 5$ °C Dipping time: 3 $\pm 0.3$ seconds Depth of immersion: 10 mm Alloy Composition: SAC305 Number of immersions: 1	

TEST	TEST METHOD	PROCEDURE	REQUIREMENTS
Rapid Change of Temperature	IEC 60384-21/22 4.11	<p>Preconditioning: 150 +0/-10 °C for 1 hour, then keep for 24 ± 1 hours at room temperature</p> <p>5 cycles with following detail: 30 minutes at lower category temperature 30 minutes at upper category temperature</p> <p>Recovery time 24 ± 2 hours</p>	<p>No visual damage</p> <hr/> <p>&lt;General purpose series&gt; ΔC/C Class2: X5R: ± 15%</p> <p>&lt;High Capacitance series&gt; ΔC/C Class2: X5R: ± 15%</p> <hr/> <p>D.F. meet initial specified value R<sub>ins</sub> meet initial specified value</p>
Damp Heat with U <sub>r</sub> Load	4.13	<ol style="list-style-type: none"> <li>Preconditioning, class 2 only: 150 +0/-10 °C / 1 hour, then keep for 24 ± 1 hour at room temp</li> <li>Initial measure: Spec: refer to initial spec C, D, IR</li> <li>Damp heat test: 500 ± 12 hours at 40 ± 2 °C; 90 to 95% R.H. 1.0 U<sub>r</sub> applied</li> <li>Recovery: Class 2: 24 ± 2 hours</li> <li>Final measure: C, D, IR</li> </ol> <p>P.S. If the capacitance value is less than the minimum value permitted, then after the other measurements have been made the capacitor shall be preconditioned according to "IEC 60384 4.1" and then the requirements shall be met.</p>	<p>No visual damage after recovery</p> <hr/> <p>&lt;General purpose series&gt; ΔC/C Class2: X5R: ± 15%</p> <p>D.F. Class2: X5R: ≤ 16V: ≤ 7% ≥ 25V: ≤ 5%</p> <p>R<sub>ins</sub> Class2: X5R: ≥ 500 MΩ or R<sub>ins</sub> × C<sub>r</sub> ≥ 25s whichever is less</p> <p>&lt;High Capacitance series&gt; ΔC/C Class2: X5R: ± 20%</p> <p>D.F. Class2: X5R: 2 × initial value max</p> <p>R<sub>ins</sub> Class2: X5R: 500 MΩ or R<sub>ins</sub> × C<sub>r</sub> ≥ 25s whichever is less</p>



TEST	TEST METHOD	PROCEDURE	REQUIREMENTS
Endurance	IEC 60384-21/22 4.14	1. Preconditioning, class 2 only: 150 +0/-10 °C /1 hour, then keep for 24 ±1 hour at room temp  2. Initial measure: Spec: refer to initial spec C, D, IR  3. Endurance test: Temperature: X5R: 85 °C Specified stress voltage applied for 1,000 hours: Applied 2.0 × U <sub>r</sub> for general product. Applied 1.5 × U <sub>r</sub> for high cap. product.  4. Recovery time: 24 ±2 hours  5. Final measure: C, D, IR  P.S. If the capacitance value is less than the minimum value permitted, then after the other measurements have been made the capacitor shall be preconditioned according to "IEC 60384 4.1" and then the requirements shall be met.	No visual damage  <General purpose series> ΔC/C Class2: X5R: ±15% D.F. Class2: X5R: ≤ 16V: ≤ 7% ≥ 25V: ≤ 5%  R <sub>ins</sub> Class2: X5R: ≥ 1,000 MΩ or R <sub>ins</sub> × C <sub>r</sub> ≥ 50s whichever is less  <High Capacitance series> ΔC/C Class 2: X5R: ±20% D.F. Class 2: X5R: 2 × initial value max  R <sub>ins</sub> Class 2: X5R: 1,000 MΩ or R <sub>ins</sub> × C <sub>r</sub> ≥ 50s whichever is less
		Specified stress voltage applied for 1 minute U <sub>r</sub> ≤ 100 V: series applied 2.5 U <sub>r</sub> 100 V < U <sub>r</sub> ≤ 200 V series applied (1.5 U <sub>r</sub> + 100) 200 V < U <sub>r</sub> ≤ 500 V series applied (1.3 U <sub>r</sub> + 100) U <sub>r</sub> > 500 V: 1.3 U <sub>r</sub>  I: 7.5 mA	No breakdown or flashover

**REVISION HISTORY**

REVISION	DATE	CHANGE NOTIFICATION	DESCRIPTION
Version 14	May 16, 2012	-	- Product range updated
Version 13	May 02, 2012	-	- Product range updated
Version 12	Feb 10, 2012	-	- Product range updated
Version 11	Oct 21, 2011	-	- Product range updated
Version 10	Jun 21, 2011	-	- Product range updated
Version 9	Mar 23, 2011	-	- Product range updated
Version 8	Jan 25, 2011	-	- Rated voltage of 0201 extend to 50V
Version 7	Jan 05, 2011	-	- Product range updated
Version 6	Jul 27, 2010	-	- Dimension on 0603 and 1206 case size updated
Version 5	Apr 21, 2010	-	- The statement of "Halogen free" on the cover added - Dimension updated
Version 4	Jan 13, 2010	-	- Thickness updated
Version 3	Aug 17, 2009	-	- Dimension updated
Version 2	Jun 09, 2009	-	- Ordering code updated
Version 1	May 15, 2009	-	- Product range updated
Version 0	Apr 15, 2009	-	- New datasheet for general purpose and high capacitance X5R series with RoHS compliant - Replace the "6.3V to 50V" part of pdf files: UP-X5R_X7R_HighCaps_6.3-to-25V_11, UY-X5R_X7R_HighCaps_6.3-to-25V_11 - Combine 0201 from pdf files: UP-NP0X5RX7RY5V_0201_6.3-to-50V_2 and UY-NP0X5RX7RY5V_0201_6.3-to-50V_2 - Define global part number - Description of "Halogen free compliant" added - Test method and procedure updated

# Mouser Electronics

Authorized Distributor

Click to View Pricing, Inventory, Delivery & Lifecycle Information:

## Yageo:

[CC0402KRX5R7BB104](#) [CC0402KRX5R6BB224](#) [CC0402KRX5R6BB104](#) [CC0402KRX5R5BB224](#)  
[CC0603KRX5R8BB474](#) [CC0603KRX5R8BB334](#) [CC0603KRX5R7BB474](#) [CC0603KRX5R6BB474](#)  
[CC0603KRX5R6BB334](#) [CC0805KKX5R6BB106](#) [CC0402KRX5R5BB105](#) [CC1206KKX5R5BB106](#)  
[CC1206KKX5R7BB475](#) [CC1210KKX5R6BB226](#) [CC0805KKX5R6BB475](#) [CC0805KKX5R6BB225](#)  
[CC0603KRX5R6BB105](#) [CC1210MKX5R6BB226](#) [CC0603KRX5R5BB225](#) [CC0603KRX5R7BB105](#)  
[CC0805MKX5R5BB226](#) [CC0603KRX5R5BB106](#) [CC0201KRX5R5BB104](#) [CC0201KRX5R6BB103](#)  
[CC0201MRX5R5BB104](#) [CC0603KRX5R6BB224](#) [CC1210KKX5R7BB106](#) [CC0805KRX5R5BB106](#)  
[CC0603KRX5R5BB475](#) [CC0603MRX5R5BB106](#) [CC1206KKX5R8BB105](#) [CC1206MKX5R5BB106](#)  
[CC0805KRX5R6BB475](#) [CC1206KKX5R7BB225](#) [CC0402KPX5R6BB104](#) [CC0402KRX5R7BB224](#)  
[CC0402MRX5R5BB225](#) [CC0805KFX5R5BB106](#) [CC0805KKX5R6BB105](#) [CC0805KKX5R7BB106](#)  
[CC0805KKX5R8BB475](#) [CC0805KRX5R6BB225](#) [CC1206KKX5R6BB106](#) [CC1210KKX5R8BB106](#)  
[CC1210MKX5R9BB106](#) [CC1210MKX5R5BB107](#) [CC0201KRX5R5BB223](#) [CC0201KRX5R5BB224](#)  
[CC0201KRX5R5BB333](#) [CC0201KRX5R5BB473](#) [CC0201MRX5R5BB224](#) [CC0805KKX5R7BB475](#)  
[CC0201KPX5R5BB104](#) [CC0201KRX5R7BB103](#) [CC0201MRX5R5BB105](#) [CC0402KPX5R5BB105](#)  
[CC0402KPX5R5BB474](#) [CC0402KRX5R5BB154](#) [CC0402KRX5R5BB225](#) [CC0402KRX5R5BB334](#)  
[CC0402KRX5R6BB154](#) [CC0402KRX5R6BB474](#) [CC0402KRX5R6BB823](#) [CC0402KRX5R7BB105](#)  
[CC0402KRX5R7BB683](#) [CC0402KRX5R9BB681](#) [CC0402MRX5R5BB104](#) [CC0402MRX5R5BB224](#)  
[CC0402MRX5R6BB104](#) [CC0402MRX5R6BB105](#) [CC0402MRX5R6BB224](#) [CC0402MRX5R7BB104](#)  
[CC0603KPX5R6BB105](#) [CC0603KPX5R6BB225](#) [CC0603KPX5R7BB105](#) [CC0603KPX5R8BB105](#)  
[CC0603KRX5R5BB224](#) [CC0603KRX5R5BB684](#) [CC0603KRX5R6BB684](#) [CC0603KRX5R7BB224](#)  
[CC0603KRX5R7BB334](#) [CC0603KRX5R7BB475](#) [CC0603KRX5R8BB224](#) [CC0603MRX5R5BB105](#)  
[CC0603MRX5R5BB225](#) [CC0603MRX5R6BB105](#) [CC0603MRX5R6BB106](#) [CC0603MRX5R6BB225](#)  
[CC0603MRX5R6BB335](#) [CC0603MRX5R6BB474](#) [CC0603MRX5R6BB475](#) [CC0603MRX5R7BB105](#)  
[CC0603MRX5R8BB224](#) [CC0201KRX5R5BB103](#) [CC0805KKX5R8BB225](#) [CC0402KRX5R5BB104](#)  
[CC0603KRX5R6BB225](#) [CC0603KRX5R6BB475](#) [CC0603KRX5R8BB105](#) [CC0805KKX5R5BB106](#)