

# DATA SHEET

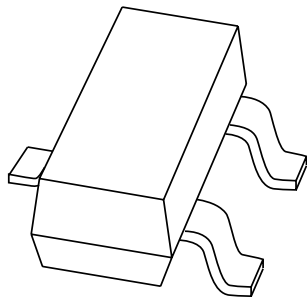

## **BZX84 series** Voltage regulator diodes

Product data sheet  
Supersedes data of 1999 May 18

2003 Apr 10

# Voltage regulator diodes

# BZX84 series

### FEATURES

- Total power dissipation: max. 250 mW
- Three tolerance series:  $\pm 1\%$ ,  $\pm 2\%$  and approx.  $\pm 5\%$
- Working voltage range: nom. 2.4 to 75 V (E24 range)
- Non-repetitive peak reverse power dissipation: max. 40 W.

### APPLICATIONS

- General regulation functions.

### DESCRIPTION

Low-power voltage regulator diodes in small SOT23 plastic SMD packages.

The diodes are available in the normalized E24  $\pm 1\%$  (BZX84-A),  $\pm 2\%$  (BZX84-B) and approx.  $\pm 5\%$  (BZX84-C) tolerance range. The series consists of 37 types with nominal working voltages from 2.4 to 75 V.

### PINNING

PIN	DESCRIPTION
1	anode
2	not connected
3	cathode

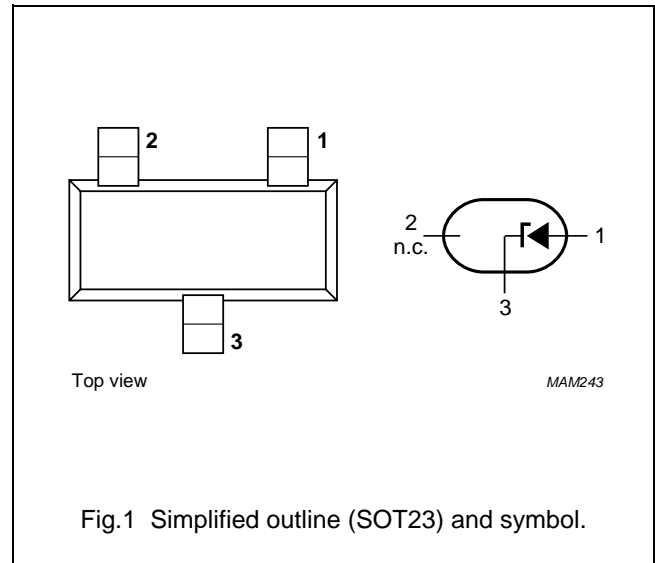

## Voltage regulator diodes

## BZX84 series

## MARKING

TYPE NUMBER	MARKING CODE <sup>(1)</sup>	TYPE NUMBER	MARKING CODE <sup>(1)</sup>	TYPE NUMBER	MARKING CODE <sup>(1)</sup>	TYPE NUMBER	MARKING CODE <sup>(1)</sup>
<b>Marking codes for BZX84-A2V4 to BZX84-A75</b>							
BZX84-A2V4	Y50 or *50	BZX84-A6V2	Y60 or *60	BZX84-A16	Y70	BZX84-A43	Y80 or *C5
BZX84-A2V7	Y51 or *51	BZX84-A6V8	Y61 or *61	BZX84-A18	Y71	BZX84-A47	Y81
BZX84-A3V0	Y52 or *52	BZX84-A7V5	Y62 or *62	BZX84-A20	Y72 or *C2	BZX84-A51	Y82 or *C6
BZX84-A3V3	Y53	BZX84-A8V2	Y63 or *63	BZX84-A22	Y73	BZX84-A56	Y83
BZX84-A3V6	Y54 or *C1	BZX84-A9V1	Y64 or *64	BZX84-A24	Y74	BZX84-A62	Y84
BZX84-A3V9	Y55 or *55	BZX84-A10	Y65 or *65	BZX84-A27	Y75 or *75	BZX84-A68	Y85
BZX84-A4V3	Y56 or *56	BZX84-A11	Y66 or *04	BZX84-A30	Y76	BZX84-A75	Y86 or *86
BZX84-A4V7	Y57 or *57	BZX84-A12	Y67 or *67	BZX84-A33	Y77	–	–
BZX84-A5V1	Y58 or *58	BZX84-A13	Y68 or *C0	BZX84-A36	Y78 or *C3	–	–
BZX84-A5V6	Y59 or *59	BZX84-A15	Y69 or *69	BZX84-A39	Y79 or *C4	–	–
<b>Marking codes for BZX84-B2V4 to BZX84-B75</b>							
BZX84-B2V4	Z50 or *Z0	BZX84-B6V2	Z60 or *R5	BZX84-B16	Z70 or *70	BZX84-B43	Z80 or *S5
BZX84-B2V7	Z51 or *Z1	BZX84-B6V8	Z61 or *R6	BZX84-B18	Z71 or *71	BZX84-B47	Z81 or *S6
BZX84-B3V0	Z52 or *S1	BZX84-B7V5	Z62 or *R8	BZX84-B20	Z72 or *72	BZX84-B51	Z82 or *S9
BZX84-B3V3	Z53 or *S2	BZX84-B8V2	Z63 or *R9	BZX84-B22	Z73 or *73	BZX84-B56	Z83 or *R0
BZX84-B3V6	Z54 or *S3	BZX84-B9V1	Z64 or *T1	BZX84-B24	Z74 or *74	BZX84-B62	Z84 or *R3
BZX84-B3V9	Z55 or *S4	BZX84-B10	Z65 or *66	BZX84-B27	Z75 or *Z5	BZX84-B68	Z85 or *R4
BZX84-B4V3	Z56 or *S7	BZX84-B11	Z66 or *Z6	BZX84-B30	Z76 or *Z4	BZX84-B75	Z86 or *R7
BZX84-B4V7	Z57 or *S8	BZX84-B12	Z67 or *Z7	BZX84-B33	Z77 or *Y1	–	–
BZX84-B5V1	Z58 or *R1	BZX84-B13	Z68 or *Z8	BZX84-B36	Z78 or *Y2	–	–
BZX84-B5V6	Z59 or *R2	BZX84-B15	Z69 or *Z9	BZX84-B39	Z79 or *S0	–	–
<b>Marking codes for BZX84-C2V4 to BZX84-C75</b>							
BZX84-C2V4	Z11 or *T3	BZX84-C6V2	Z4*	BZX84-C16	Y5*	BZX84-C43	Y15 or *B4
BZX84-C2V7	Z12 or *T4	BZX84-C6V8	Z5*	BZX84-C18	Y6*	BZX84-C47	Y16 or *B5
BZX84-C3V0	Z13 or *T9	BZX84-C7V5	Z6*	BZX84-C20	Y7*	BZX84-C51	Y17 or *B7
BZX84-C3V3	Z14 or *B1	BZX84-C8V2	Z7*	BZX84-C22	Y8*	BZX84-C56	Y18 or *B8
BZX84-C3V6	Z15 or *B2	BZX84-C9V1	Z8*	BZX84-C24	Y9*	BZX84-C62	Y19 or *B9
BZX84-C3V9	Z16 or *B3	BZX84-C10	Z9*	BZX84-C27	Y10 or *T2	BZX84-C68	Y20 or *B0
BZX84-C4V3	Z17 or *B6	BZX84-C11	Y1*	BZX84-C30	Y11 or *T5	BZX84-C75	Y21 or *A1
BZX84-C4V7	Z1*	BZX84-C12	Y2*	BZX84-C33	Y12 or *T6	–	–
BZX84-C5V1	Z2*	BZX84-C13	Y3*	BZX84-C36	Y13 or *T7	–	–
BZX84-C5V6	Z3*	BZX84-C15	Y4*	BZX84-C39	Y14 or *T8	–	–

## Note

- \* = p : Made in Hong Kong.  
\* = t : Made in Malaysia.  
\* = W : Made in China.

## Voltage regulator diodes

## BZX84 series

**LIMITING VALUES**

In accordance with the Absolute Maximum Rating System (IEC 60134).

SYMBOL	PARAMETER	CONDITIONS	MIN.	MAX.	UNIT
$I_F$	continuous forward current		–	200	mA
$I_{ZSM}$	non-repetitive peak reverse current	$t_p = 100 \mu\text{s}$ ; square wave; $T_j = 25 \text{ }^\circ\text{C}$ prior to surge	see Tables 1 and 2		
$P_{tot}$	total power dissipation	$T_{amb} = 25 \text{ }^\circ\text{C}$ ; note 1	–	250	mW
$P_{ZSM}$	non-repetitive peak reverse power dissipation	$t_p = 100 \mu\text{s}$ ; square wave; $T_j = 25 \text{ }^\circ\text{C}$ prior to surge; see Fig.2	–	40	W
$T_{stg}$	storage temperature		–65	+150	$^\circ\text{C}$
$T_j$	junction temperature		–65	+150	$^\circ\text{C}$

**Note**

1. Device mounted on an FR4 printed circuit-board.

**ELECTRICAL CHARACTERISTICS****Total BZX84-A and B and C series** $T_j = 25 \text{ }^\circ\text{C}$  unless otherwise specified.

SYMBOL	PARAMETER	CONDITIONS	MAX.	UNIT
$V_F$	forward voltage	$I_F = 10 \text{ mA}$ ; see Fig.3	0.9	V
$I_R$	reverse current			
	BZX84-A/B/C2V4	$V_R = 1 \text{ V}$	50	$\mu\text{A}$
	BZX84-A/B/C2V7	$V_R = 1 \text{ V}$	20	$\mu\text{A}$
	BZX84-A/B/C3V0	$V_R = 1 \text{ V}$	10	$\mu\text{A}$
	BZX84-A/B/C3V3	$V_R = 1 \text{ V}$	5	$\mu\text{A}$
	BZX84-A/B/C3V6	$V_R = 1 \text{ V}$	5	$\mu\text{A}$
	BZX84-A/B/C3V9	$V_R = 1 \text{ V}$	3	$\mu\text{A}$
	BZX84-A/B/C4V3	$V_R = 1 \text{ V}$	3	$\mu\text{A}$
	BZX84-A/B/C4V7	$V_R = 2 \text{ V}$	3	$\mu\text{A}$
	BZX84-A/B/C5V1	$V_R = 2 \text{ V}$	2	$\mu\text{A}$
	BZX84-A/B/C5V6	$V_R = 2 \text{ V}$	1	$\mu\text{A}$
	BZX84-A/B/C6V2	$V_R = 4 \text{ V}$	3	$\mu\text{A}$
	BZX84-A/B/C6V8	$V_R = 4 \text{ V}$	2	$\mu\text{A}$
	BZX84-A/B/C7V5	$V_R = 5 \text{ V}$	1	$\mu\text{A}$
	BZX84-A/B/C8V2	$V_R = 5 \text{ V}$	700	nA
	BZX84-A/B/C9V1	$V_R = 6 \text{ V}$	500	nA
	BZX84-A/B/C10	$V_R = 7 \text{ V}$	200	nA
BZX84-A/B/C11	$V_R = 8 \text{ V}$	100	nA	
BZX84-A/B/C12	$V_R = 8 \text{ V}$	100	nA	
BZX84-A/B/C13	$V_R = 8 \text{ V}$	100	nA	
BZX84-A/B/C15 to 75	$V_R = 0.7V_{Znom}$	50	nA	

## Voltage regulator diodes

## BZX84 series

**Table 1** Per type BZX84-A/B/C2V4 to A/B/C24 $T_j = 25\text{ °C}$  unless otherwise specified.

BZX84- Axxx Bxxx Cxxx	WORKING VOLTAGE $V_z$ (V) at $I_{ztest} = 5\text{ mA}$						DIFFERENTIAL RESISTANCE $r_{dif}$ ( $\Omega$ )				TEMP. COEFF. $S_z$ (mV/K) at $I_{ztest} = 5\text{ mA}$ (see Figs 4 and 5)			DIODE CAP. $C_d$ (pF) at $f = 1\text{ MHz}$ ; $V_R = 0\text{ V}$	NON-REPETITIVE PEAK REVERSE CURRENT $I_{zSM}$ (A) at $t_p = 100\text{ }\mu\text{s}$ ; $T_{amb} = 25\text{ °C}$
	Tol. $\pm 1\%$ (A)		Tol. $\pm 2\%$ (B)		Tol. approx. $\pm 5\%$ (C)		at $I_{ztest} = 1\text{ mA}$		at $I_{ztest} = 5\text{ mA}$		MIN.	TYP.	MAX.	MAX.	MAX.
	MIN.	MAX.	MIN.	MAX.	MIN.	MAX.	TYP.	MAX.	TYP.	MAX.					
2V4	2.37	2.43	2.35	2.45	2.2	2.6	275	600	70	100	-3.5	-1.6	0	450	6.0
2V7	2.67	2.73	2.65	2.75	2.5	2.9	300	600	75	100	-3.5	-2.0	0	450	6.0
3V0	2.97	3.03	2.94	3.06	2.8	3.2	325	600	80	95	-3.5	-2.1	0	450	6.0
3V3	3.26	3.34	3.23	3.37	3.1	3.5	350	600	85	95	-3.5	-2.4	0	450	6.0
3V6	3.56	3.64	3.53	3.67	3.4	3.8	375	600	85	90	-3.5	-2.4	0	450	6.0
3V9	3.86	3.94	3.82	3.98	3.7	4.1	400	600	85	90	-3.5	-2.5	0	450	6.0
4V3	4.25	4.35	4.21	4.39	4.0	4.6	410	600	80	90	-3.5	-2.5	0	450	6.0
4V7	4.65	4.75	4.61	4.79	4.4	5.0	425	500	50	80	-3.5	-1.4	0.2	300	6.0
5V1	5.04	5.16	5.00	5.20	4.8	5.4	400	480	40	60	-2.7	-0.8	1.2	300	6.0
5V6	5.54	5.66	5.49	5.71	5.2	6.0	80	400	15	40	-2.0	1.2	2.5	300	6.0
6V2	6.13	6.27	6.08	6.32	5.8	6.6	40	150	6	10	0.4	2.3	3.7	200	6.0
6V8	6.73	6.87	6.66	6.94	6.4	7.2	30	80	6	15	1.2	3.0	4.5	200	6.0
7V5	7.42	7.58	7.35	7.65	7.0	7.9	30	80	6	15	2.5	4.0	5.3	150	4.0
8V2	8.11	8.29	8.04	8.36	7.7	8.7	40	80	6	15	3.2	4.6	6.2	150	4.0
9V1	9.00	9.20	8.92	9.28	8.5	9.6	40	100	6	15	3.8	5.5	7.0	150	3.0
10	9.90	10.10	9.80	10.20	9.4	10.6	50	150	8	20	4.5	6.4	8.0	90	3.0
11	10.80	11.11	10.80	11.20	10.4	11.6	50	150	10	20	5.4	7.4	9.0	85	2.5
12	11.88	12.12	11.80	12.20	11.4	12.7	50	150	10	25	6.0	8.4	10.0	85	2.5
13	12.87	13.13	12.70	13.30	12.4	14.1	50	170	10	30	7.0	9.4	11.0	80	2.5
15	14.85	15.15	14.70	15.30	13.8	15.6	50	200	10	30	9.2	11.4	13.0	75	2.0
16	15.84	16.16	15.70	16.30	15.3	17.1	50	200	10	40	10.4	12.4	14.0	75	1.5
18	17.82	18.18	17.60	18.40	16.8	19.1	50	225	10	45	12.4	14.4	16.0	70	1.5
20	19.80	20.20	19.60	20.40	18.8	21.2	60	225	15	55	14.4	16.4	18.0	60	1.5
22	21.78	22.22	21.60	22.40	20.8	23.3	60	250	20	55	16.4	18.4	20.0	60	1.25
24	23.76	24.24	23.50	24.50	22.8	25.6	60	250	25	70	18.4	20.4	22.0	55	1.25

## Voltage regulator diodes

## BZX84 series

**Table 2** Per type BZX84-A/B/C27 to A/B/C75 $T_j = 25\text{ °C}$  unless otherwise specified.

BZX84- Axxx Bxxx Cxxx	WORKING VOLTAGE $V_z$ (V) at $I_{ztest} = 2\text{ mA}$						DIFFERENTIAL RESISTANCE $r_{dif}$ ( $\Omega$ )				TEMP. COEFF. $S_z$ (mV/K) at $I_{ztest} = 2\text{ mA}$ (see Figs 4 and 5)			DIODE CAP. $C_d$ (pF) at $f = 1\text{ MHz}$ ; $V_R = 0\text{ V}$	NON-REPETITIVE PEAK REVERSE CURRENT $I_{zSM}$ (A) at $t_p = 100\text{ }\mu\text{s}$ ; $T_{amb} = 25\text{ °C}$
	Tol. $\pm 1\%$ (A)		Tol. $\pm 2\%$ (B)		Tol. approx. $\pm 5\%$ (C)		at $I_{ztest} = 0.5\text{ mA}$		at $I_{ztest} = 2\text{ mA}$		MIN.	TYP.	MAX.	MAX.	MAX.
	MIN.	MAX.	MIN.	MAX.	MIN.	MAX.	TYP.	MAX.	TYP.	MAX.					
27	26.73	27.27	26.50	27.50	25.1	28.9	65	300	25	80	21.4	23.4	25.3	50	1.0
30	29.70	30.30	29.40	30.60	28.0	32.0	70	300	30	80	24.4	26.6	29.4	50	1.0
33	32.67	33.33	32.30	33.70	31.0	35.0	75	325	35	80	27.4	29.7	33.4	45	0.9
36	35.64	36.36	35.30	36.70	34.0	38.0	80	350	35	90	30.4	33.0	37.4	45	0.8
39	38.61	39.39	38.20	39.80	37.0	41.0	80	350	40	130	33.4	36.4	41.2	45	0.7
43	42.57	43.43	42.10	43.90	40.0	46.0	85	375	45	150	37.6	41.2	46.6	40	0.6
47	46.53	47.47	46.10	47.90	44.0	50.0	85	375	50	170	42.0	46.1	51.8	40	0.5
51	50.49	51.51	50.00	52.00	48.0	54.0	90	400	60	180	46.6	51.0	57.2	40	0.4
56	55.44	56.56	54.90	57.10	52.0	60.0	100	425	70	200	52.2	57.0	63.8	40	0.3
62	61.38	62.62	60.80	63.20	58.0	66.0	120	450	80	215	58.8	64.4	71.6	35	0.3
68	67.32	68.68	66.60	69.40	64.0	72.0	150	475	90	240	65.6	71.7	79.8	35	0.25
75	74.25	75.75	73.50	76.50	70.0	79.0	170	500	95	255	73.4	80.2	88.6	35	0.2

## Voltage regulator diodes

## BZX84 series

**THERMAL CHARACTERISTICS**

<b>SYMBOL</b>	<b>PARAMETER</b>	<b>CONDITIONS</b>	<b>VALUE</b>	<b>UNIT</b>
$R_{th\ j-tp}$	thermal resistance from junction to tie-point		330	K/W
$R_{th\ j-a}$	thermal resistance from junction to ambient	note 1	500	K/W

**Note**

1. Device mounted on an FR4 printed circuit-board.

Voltage regulator diodes

BZX84 series

GRAPHICAL DATA

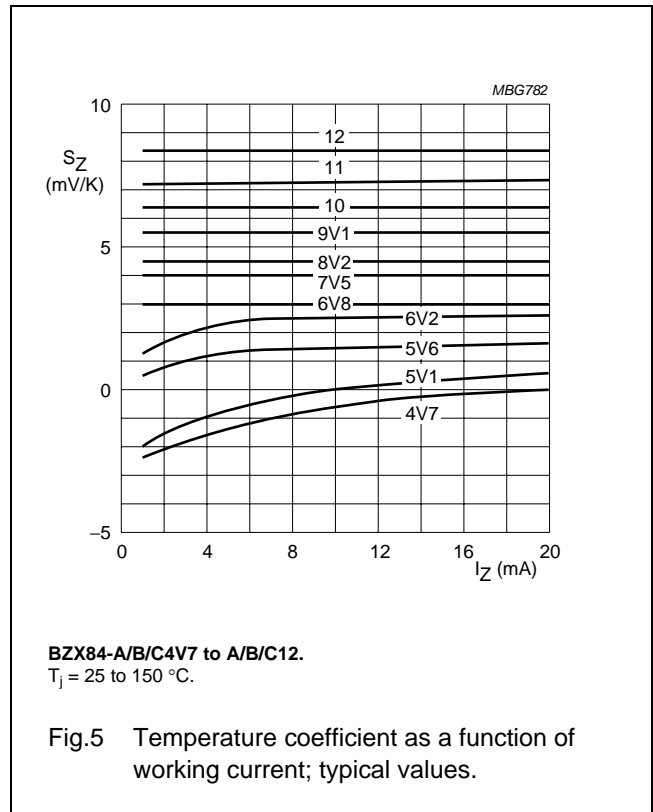
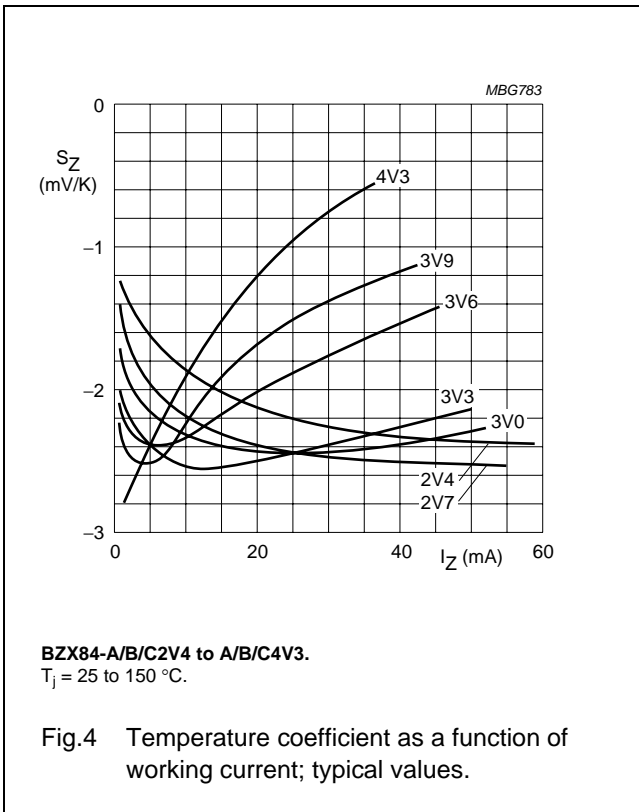
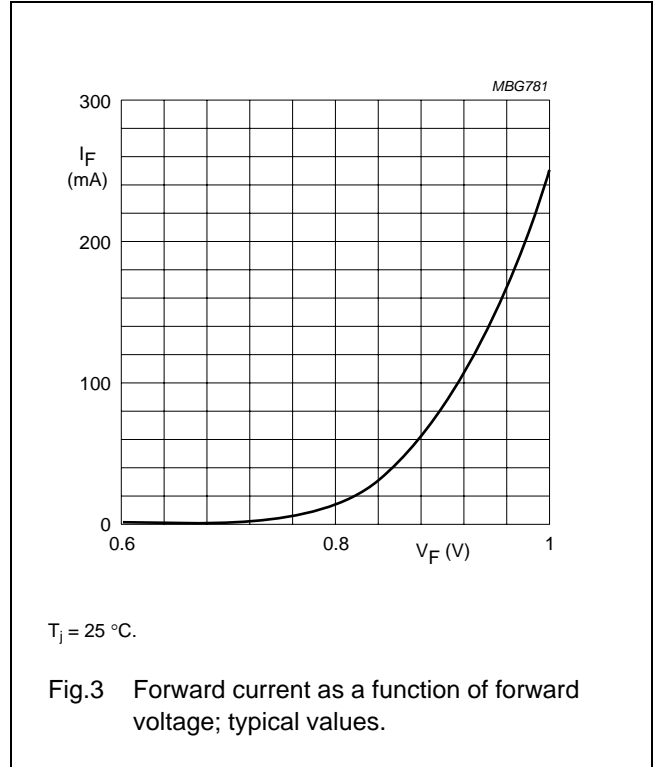
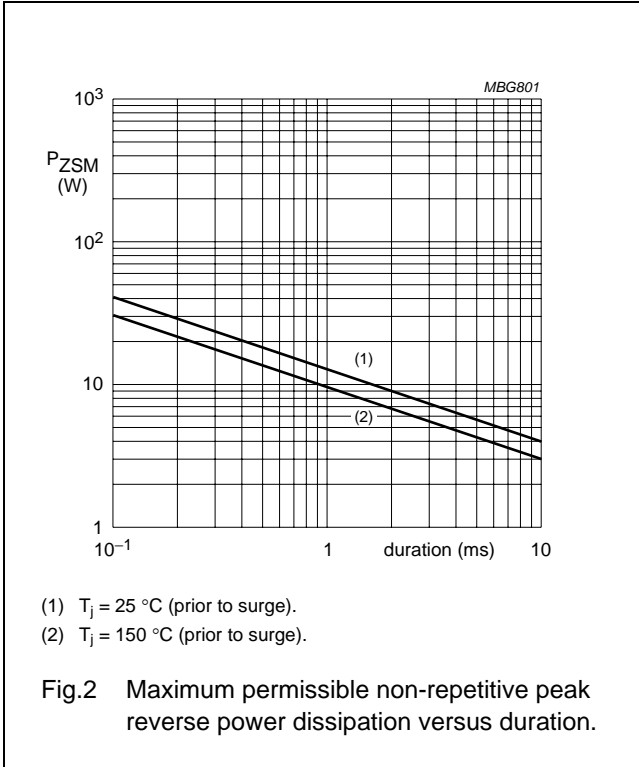



Voltage regulator diodes

BZX84 series

PACKAGE OUTLINE

Plastic surface mounted package; 3 leads

SOT23

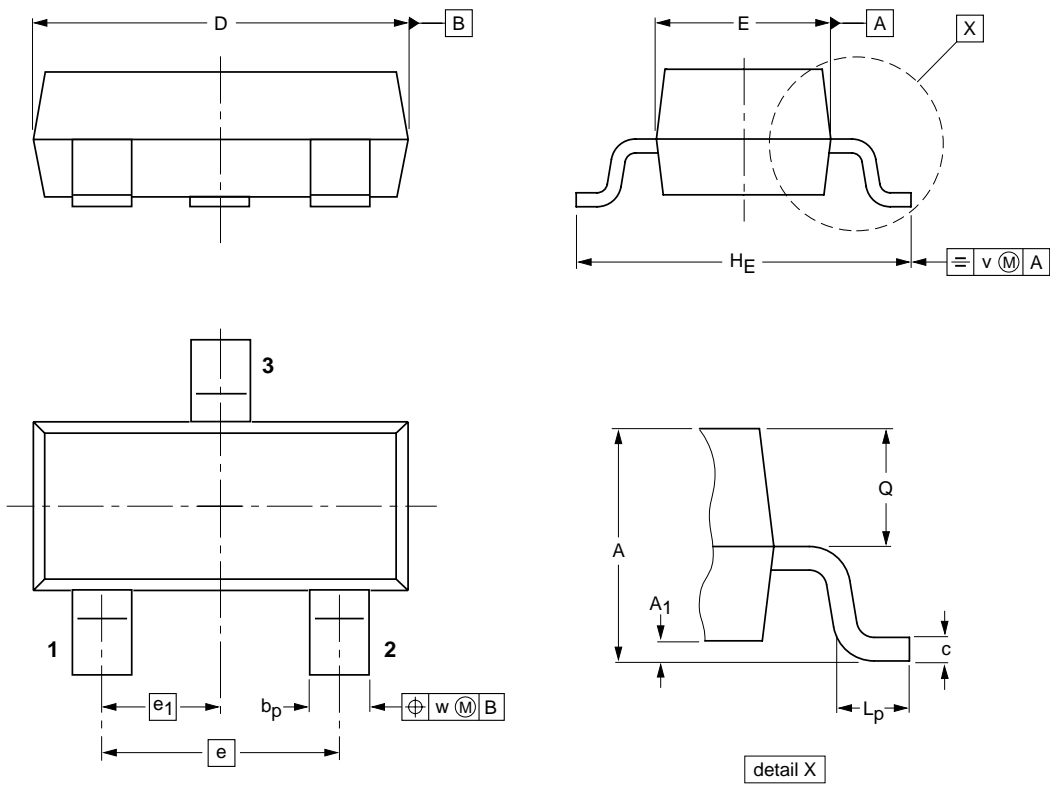

DIMENSIONS (mm are the original dimensions)

UNIT	A	A <sub>1</sub> max.	b <sub>p</sub>	c	D	E	e	e <sub>1</sub>	H <sub>E</sub>	L <sub>p</sub>	Q	v	w
mm	1.1 0.9	0.1	0.48 0.38	0.15 0.09	3.0 2.8	1.4 1.2	1.9	0.95	2.5 2.1	0.45 0.15	0.55 0.45	0.2	0.1

OUTLINE VERSION	REFERENCES			EUROPEAN PROJECTION	ISSUE DATE
	IEC	JEDEC	EIAJ		
SOT23		TO-236AB			97-02-28 99-09-13

Voltage regulator diodes

BZX84 series

**DATA SHEET STATUS**

DOCUMENT STATUS <sup>(1)</sup>	PRODUCT STATUS <sup>(2)</sup>	DEFINITION
Objective data sheet	Development	This document contains data from the objective specification for product development.
Preliminary data sheet	Qualification	This document contains data from the preliminary specification.
Product data sheet	Production	This document contains the product specification.

**Notes**

1. Please consult the most recently issued document before initiating or completing a design.
2. The product status of device(s) described in this document may have changed since this document was published and may differ in case of multiple devices. The latest product status information is available on the Internet at URL <http://www.nxp.com>.

**DISCLAIMERS**

**General** — Information in this document is believed to be accurate and reliable. However, NXP Semiconductors does not give any representations or warranties, expressed or implied, as to the accuracy or completeness of such information and shall have no liability for the consequences of use of such information.

**Right to make changes** — NXP Semiconductors reserves the right to make changes to information published in this document, including without limitation specifications and product descriptions, at any time and without notice. This document supersedes and replaces all information supplied prior to the publication hereof.

**Suitability for use** — NXP Semiconductors products are not designed, authorized or warranted to be suitable for use in medical, military, aircraft, space or life support equipment, nor in applications where failure or malfunction of an NXP Semiconductors product can reasonably be expected to result in personal injury, death or severe property or environmental damage. NXP Semiconductors accepts no liability for inclusion and/or use of NXP Semiconductors products in such equipment or applications and therefore such inclusion and/or use is at the customer's own risk.

**Applications** — Applications that are described herein for any of these products are for illustrative purposes only. NXP Semiconductors makes no representation or warranty that such applications will be suitable for the specified use without further testing or modification.

**Limiting values** — Stress above one or more limiting values (as defined in the Absolute Maximum Ratings

System of IEC 60134) may cause permanent damage to the device. Limiting values are stress ratings only and operation of the device at these or any other conditions above those given in the Characteristics sections of this document is not implied. Exposure to limiting values for extended periods may affect device reliability.

**Terms and conditions of sale** — NXP Semiconductors products are sold subject to the general terms and conditions of commercial sale, as published at <http://www.nxp.com/profile/terms>, including those pertaining to warranty, intellectual property rights infringement and limitation of liability, unless explicitly otherwise agreed to in writing by NXP Semiconductors. In case of any inconsistency or conflict between information in this document and such terms and conditions, the latter will prevail.

**No offer to sell or license** — Nothing in this document may be interpreted or construed as an offer to sell products that is open for acceptance or the grant, conveyance or implication of any license under any copyrights, patents or other industrial or intellectual property rights.

**Export control** — This document as well as the item(s) described herein may be subject to export control regulations. Export might require a prior authorization from national authorities.

**Quick reference data** — The Quick reference data is an extract of the product data given in the Limiting values and Characteristics sections of this document, and as such is not complete, exhaustive or legally binding.

# ***NXP Semiconductors***

## **Customer notification**

This data sheet was changed to reflect the new company name NXP Semiconductors. No changes were made to the content, except for the legal definitions and disclaimers.

## **Contact information**

For additional information please visit: **<http://www.nxp.com>**

For sales offices addresses send e-mail to: **[salesaddresses@nxp.com](mailto:salesaddresses@nxp.com)**

© NXP B.V. 2009

All rights are reserved. Reproduction in whole or in part is prohibited without the prior written consent of the copyright owner.

The information presented in this document does not form part of any quotation or contract, is believed to be accurate and reliable and may be changed without notice. No liability will be accepted by the publisher for any consequence of its use. Publication thereof does not convey nor imply any license under patent- or other industrial or intellectual property rights.

Printed in The Netherlands

613514/03/pp11

Date of release: 2003 Apr 10

Document order number: 9397 750 10959

