

PNP SILICON PLANAR EPITAXIAL TRANSISTORS

BC856, BC857, BC858

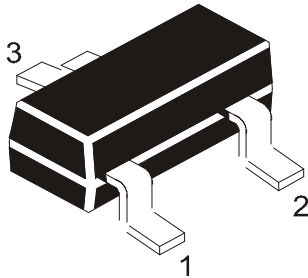

PIN CONFIGURATION (PNP)

- 1 = BASE
- 2 = EMITTER
- 3 = COLLECTOR

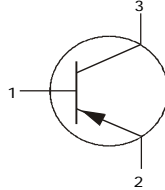

SOT-23
Formed SMD Package
 For Lead Free Parts, Device Part #
 will be Prefixed with "T"

Marking

- BC856 =3D
- BC856A=3A
- BC856B=3B
- BC857 =3H
- BC857A=3E
- BC857B=3F
- BC857C=3G
- BC858 =3M
- BC858A=3J
- BC858B=3K
- BC858C=3L

ABSOLUTE MAXIMUM RATINGS (Ta=25°C unless specified otherwise)

DESCRIPTION	SYMBOL	BC856	BC857	BC858	UNITS
Collector Base Voltage	V_{CBO}	80	50	30	V
Collector Emitter Voltage	V_{CEO}	65	45	30	V
Emitter Base Voltage	V_{EBO}	5			V
Collector Current (DC)	I_C	100			mA
Collector Current - Peak	I_{CM}	200			mA
Power Dissipation	P_{tot}	200			mW
Storage Temperature	T_{stg}	-65 to +150			°C
Junction Temperature	T_j	150			°C

ELECTRICAL CHARACTERISTICS (Ta=25°C unless specified otherwise)

DESCRIPTION	SYMBOL	TEST CONDITION	MIN	TYP	MAX	UNITS
DC Current Gain	h_{FE}	$I_C=2mA, V_{CE}=5V$	A	125	250	
			B	220	475	
			C	420	800	
Collector Cut off Current	I_{CBO}	$V_{CB}=30V, I_E=0$			15	nA
Collector Base Voltage	V_{CBO}	$I_C=10\mu A, I_E=0$	BC856	80		V
			BC857	50		V
			BC858	30		V
Collector Emitter Voltage	V_{CES}	$I_C=10\mu A, V_{BE}=0$	BC856	80		V
			BC857	50		V
			BC858	30		V

PNP SILICON PLANAR EPITAXIAL TRANSISTORS

BC856, BC857, BC858

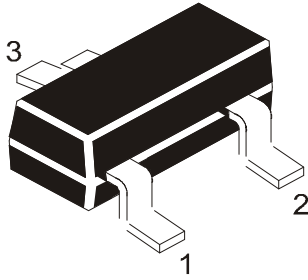

PIN CONFIGURATION (PNP)

- 1 = BASE
- 2 = EMITTER
- 3 = COLLECTOR

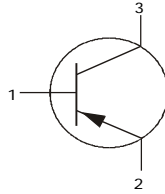

SOT-23
Formed SMD Package

For Lead Free Parts, Device Part # will be Prefixed with "T"

ELECTRICAL CHARACTERISTICS (Ta=25°C unless specified otherwise)

DESCRIPTION	SYMBOL	TEST CONDITION	MIN	TYP	MAX	UNITS
Collector Emitter Voltage	V_{CEO}	$I_C=1mA, I_B=0$				
		BC856	65			V
		BC857	45			V
		BC858	30			V
Emitter Base Voltage	V_{EBO}	$I_E=1\mu A, I_C=0$	5			V
Collector Emitter Saturation Voltage	$V_{CE(Sat)}$	$I_C=10mA, I_B=0.5mA$			0.30	V
		$I_C=100mA, I_B=5mA$			0.65	V
Base Emitter on Voltage	$V_{BE(on)}$	$I_C=2mA, V_{CE}=5V$	0.6		0.75	V
		$I_C=10mA, V_{CE}=5V$			0.82	V
Transition Frequency	f_T	$I_C=10mA, V_{CE}=5V, f=100MHz$	100			MHz
Output Capacitance	C_{ob}	$V_{CB}=10V, f=1MHz$			6.0	pF
Noise Figure	NF	$I_C=0.2mA, V_{CE}=5V$ $R_s=2k\Omega, f=1KHz$			10	dB

BC856_858 Rev_2 141210P

SOT-23
Formed SMD Package
 For Lead Free Parts, Device Part #
 will be Prefixed with "T"

SOT-23 Formed SMD Package

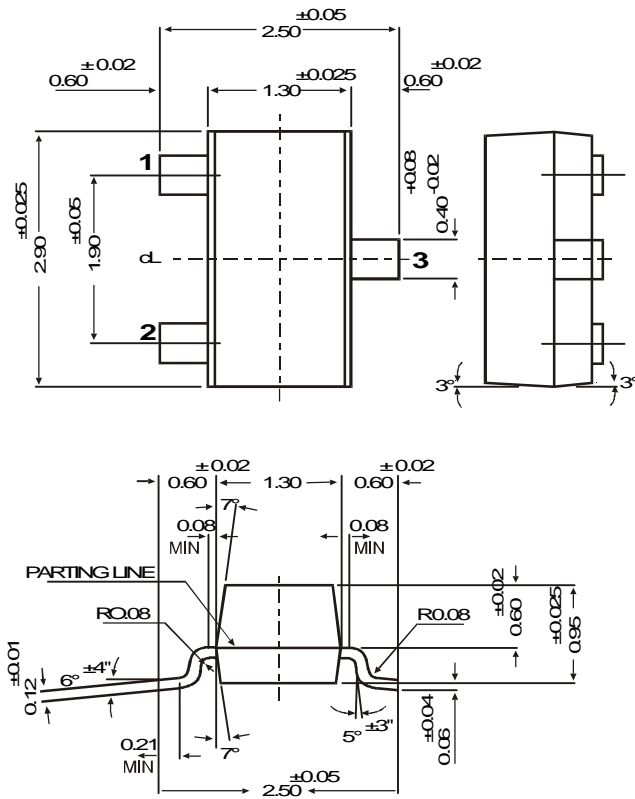

SOT-23 Package Reel Information
Reel Specifications for W Packing (13" and 7")

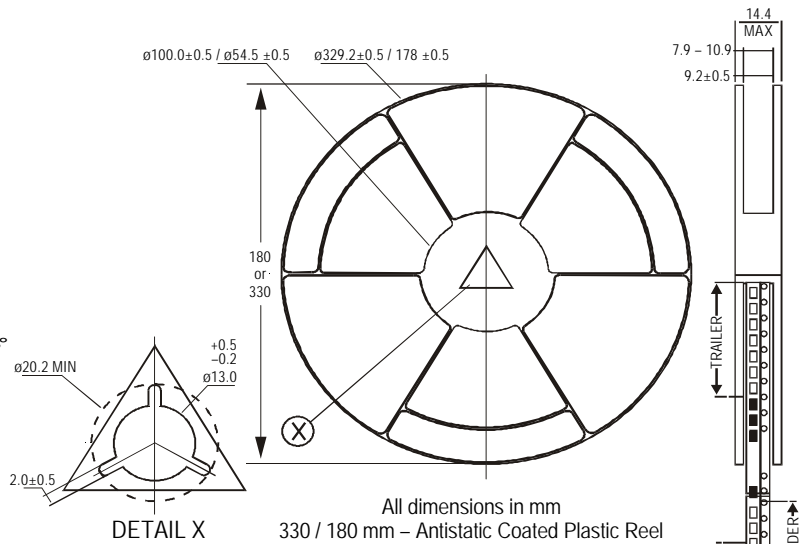

NOTES:

1. The bandolier of 330 mm reel contains at least 10,000 devices.
2. The bandolier of 180 mm reel contains at least 3,000 devices.
3. No more than 0.5% missing devices / reel. 50 empty compartments for 330 mm reel. 15 empty compartments for 180 mm reel.
4. Three consecutive empty places might be found provided this gap is followed by 6 consecutive devices.
5. The carrier tape (leader) starts with at least 75 empty positions (equivalent to 330 mm). In order to fix the carrier tape a self adhesive tape of 20 to 50 mm is applied. At the end of the bandolier at least 40 empty positions (equivalent to 160 mm) are there.

Size of Reel	8mm Tape Size of Reel	8mm Tape Size of Reel
330 mm (13")	330 mm (13")	180 mm (7")
No. of Devices	10,000 Pcs	3,000 Pcs

Tape Specification for SOT-23 Surface Mount Device

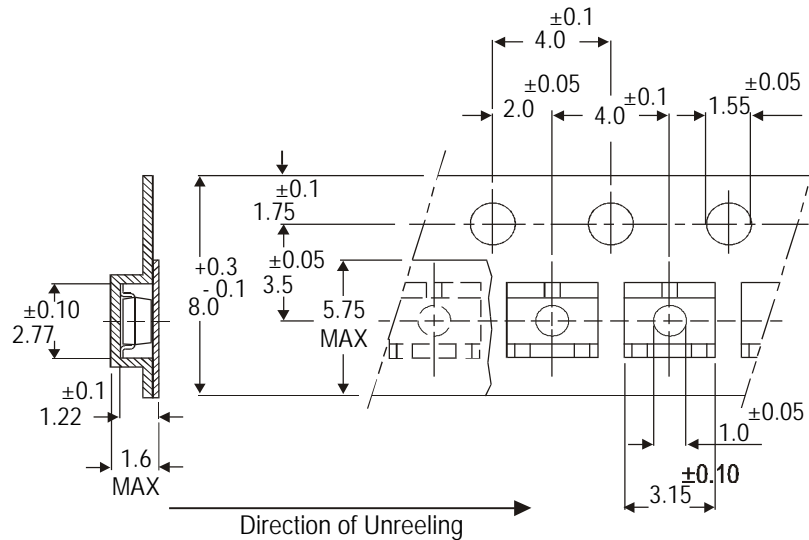

All dimensions in mm

Packing Detail

PACKAGE	STANDARD PACK		INNER CARTON BOX		OUTER CARTON BOX		
	Details	Net Weight/Qty	Size	Qty	Size	Qty	Gr Wt
SOT-23 T&R	3K/feel	136 gm/3K pcs	3" x 7.5" x 7.5"	12 K	17" x 15" x 13.5"	192 K	12 kgs
	10K/feel	415 gm/10K pcs	9" x 9" x 9"	51 K	19" x 19" x 19"	408 K	28 kgs
			13" x 13" x 0.5"	10 K	17" x 15" x 13.5"	300 K	16 kgs

SOT-23**Formed SMD Package**

For Lead Free Parts, Device Part #
will be Prefixed with "T"

Component Disposal Instructions

1. CDIL Semiconductor Devices are RoHS compliant, customers are requested to please dispose as per prevailing Environmental Legislation of their Country.
2. In Europe, please dispose as per EU Directive 2002/96/EC on Waste Electrical and Electronic Equipment (WEEE).

Disclaimer

The product information and the selection guides facilitate selection of the CDIL's Discrete Semiconductor Device(s) best suited for application in your product(s) as per your requirement. It is recommended that you completely review our Data Sheet(s) so as to confirm that the Device(s) meet functionality parameters for your application. The information furnished in the Data Sheet and on the CDIL Web Site/CD is believed to be accurate and reliable. CDIL however, does not assume responsibility for inaccuracies or incomplete information. Furthermore, CDIL does not assume liability whatsoever, arising out of the application or use of any CDIL product; neither does it convey any license under its patent rights nor rights of others. These products are not designed for use in life saving/support appliances or systems. CDIL customers selling these products (either as individual Discrete Semiconductor Devices or incorporated in their end products), in any life saving/support appliances or systems or applications do so at their own risk and CDIL will not be responsible for any damages resulting from such sale(s).

CDIL strives for continuous improvement and reserves the right to change the specifications of its products without prior notice.



CDIL is a registered Trademark of
Continental Device India Limited

C-120 Naraina Industrial Area, New Delhi 110 028, India.

Telephone + 91-11-2579 6150, 5141 1112 Fax + 91-11-2579 5290, 5141 1119

email@cdil.com www.cdilsemi.com