

## NPN SILICON PLANAR EPITAXIAL TRANSISTORS

**BC846 BC847  
BC848**

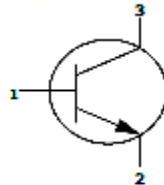
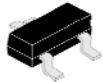

SOT-23

**SOT-23  
SMD Package  
RoHS compliant**

### Marking Details

BC846 =1D  
BC846A=1A  
BC846B=1B  
BC847 =1H  
BC847A=1E  
BC847B=1F  
BC847C=1G  
BC848 =1M  
BC848A=1J  
BC848B=1K  
BC848C=1L

### GENERAL DISCRIPTION:

For use in Driver Stages of Audio Amplifier in Thick and Thin-film Hybrid Circuits

### APPLICATION:

General Purpose Switching Applications.

### ABSOLUTE MAXIMUM RATINGS (Ta = 25 °C Unless otherwise specified)

| PARAMETER                 | SYMBOL    | VALUE       |       |       | UNIT |
|---------------------------|-----------|-------------|-------|-------|------|
|                           |           | BC846       | BC847 | BC848 |      |
| Collector Base Voltage    | $V_{CBO}$ | 80          | 50    | 30    | V    |
| Collector Emitter Voltage | $V_{CEO}$ | 65          | 45    | 30    | V    |
| Emitter Base Voltage      | $V_{EBO}$ | 6           | 6     | 5     | V    |
| Collector Current (DC)    | $I_C$     | 100         |       |       | mA   |
| Collector Current - Peak  | $I_{CM}$  | 200         |       |       | mA   |
| Power Dissipation         | $P_{tot}$ | 250         |       |       | mW   |
| Storage Temperature       | $T_{stg}$ | -65 to +150 |       |       | °C   |
| Junction Temperature      | $T_j$     | 150         |       |       | °C   |



Continental Device India Pvt. Limited

An IATF 16949, ISO9001 and ISO 14001 Certified Company



**ELECTRICAL CHARACTERISTICS at** (Ta = 25 °C Unless otherwise specified)

| PARAMETER                            | SYMBOLS              | TEST CONDITION  | VALUE |     |      | UNIT |
|--------------------------------------|----------------------|---|-------|-----|------|------|
|                                      |                      |   | MIN   | TYP | MAX  |      |
| DC Current Gain                      | h <sub>FE</sub>      | I <sub>C</sub> =2mA, V <sub>CE</sub> =5V                                  |       |     |      |      |
|                                      |                      | A   | 110   | --  | 220  |      |
|                                      |                      | B   | 200   | --  | 450  |      |
|                                      |                      | C   | 420   | --  | 800  |      |
| Collector Emitter Saturation Voltage | V <sub>CE(Sat)</sub> | I <sub>C</sub> =10mA, I <sub>B</sub> =0.5mA                               | --    | --  | 0.25 | V    |
|                                      |                      | I <sub>C</sub> =100mA, I <sub>B</sub> =5mA                                | --    | --  | 0.60 | V    |
| Base Emitter on Voltage              | V <sub>BE(on)</sub>  | I <sub>C</sub> =2mA, V <sub>CE</sub> =5V                                  | 0.58  | --  | 0.70 | V    |
|                                      |                      | I <sub>C</sub> =10mA, V <sub>CE</sub> =5V                                 | --    | --  | 0.72 | V    |
| Collector Cut off Current            | I <sub>CBO</sub>     | V <sub>CB</sub> =30V, I <sub>E</sub> =0                                   | --    | --  | 15   | nA   |
| Transition Frequency                 | f <sub>T</sub>       | I <sub>C</sub> =10mA, V <sub>CE</sub> =5V, f=100MHz                       | --    | 300 | --   | MHz  |
| Output Capacitance                   | C <sub>ob</sub>      | V <sub>CB</sub> =10V, f=1MHz  | --    | --  | 6.0  | pF   |
| Input Capacitance                    | C <sub>ib</sub>      | V <sub>EB</sub> =0.5V, f=1MHz   | --    | 9.0 | --   | pF   |
| Noise Figure                         | N <sub>F</sub>       | I <sub>C</sub> =0.2mA, V <sub>CE</sub> =5V<br>R <sub>s</sub> =2kW, f=1KHz | --    | --  | 10   | dB   |

### TYPICAL CHARACTERISTICS CURVES

Fig 1:  $I_c$  vs  $hFE$  Plot  $V_{ce} = 5V$

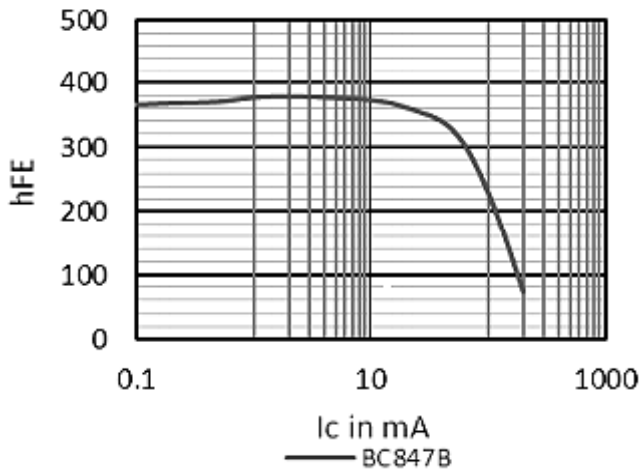

Fig 2: Normalized  $I_c$  vs  $hFE$  Plot  $V_{ce} = 5V$

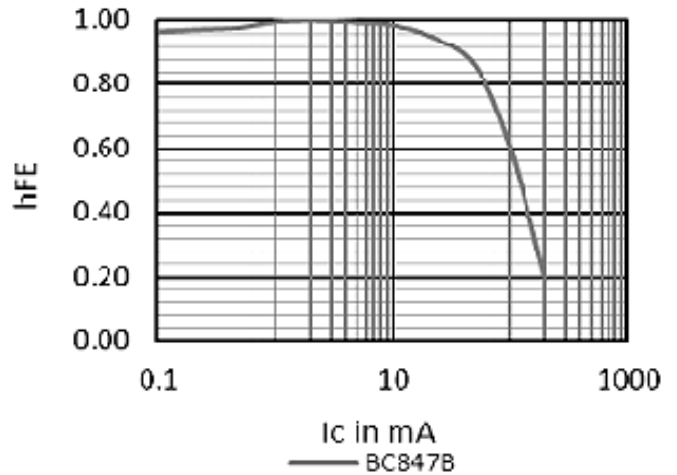

Fig 3:  $I_c$  vs  $V_{besat}$  Plot  $I_c/I_b=20$

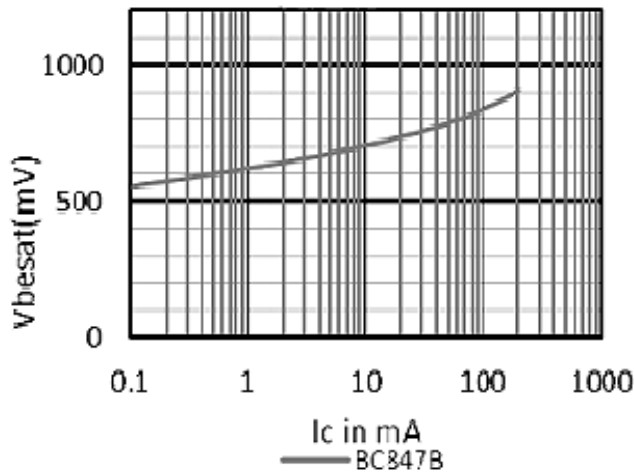
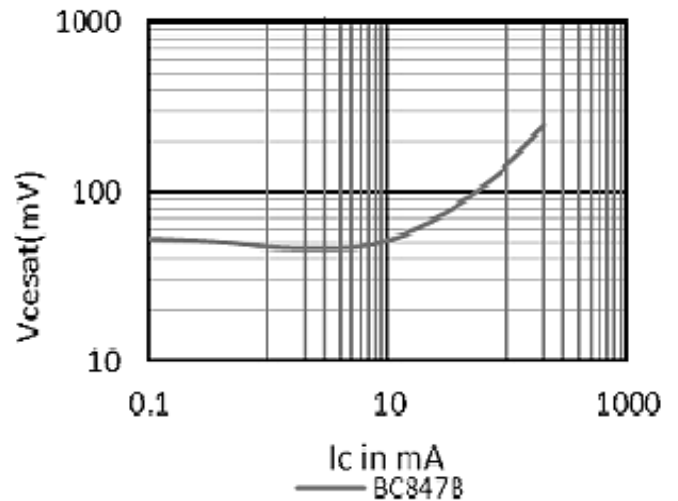
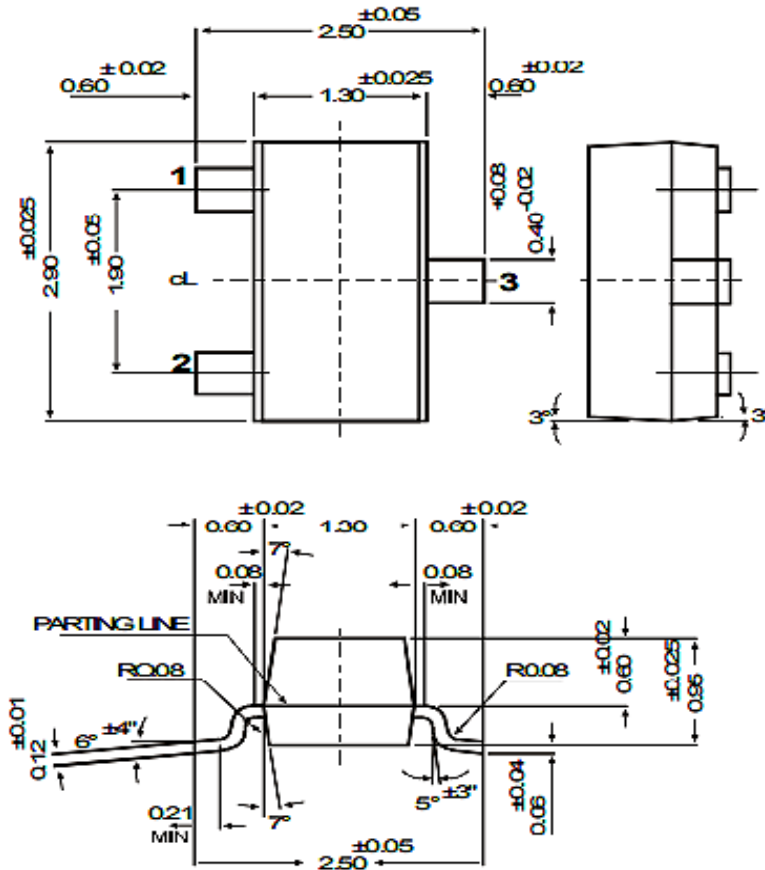

Fig 4:  $I_c$  vs  $V_{cesat}$  Plot  $I_c/I_b=20$



### Package Details:

#### SOT-23 SMD Package



All dimensions are in mm

#### PIN CONFIGURATION (NPN)

1. Base
2. Emitter
3. Collector

### SOT-23 Package Reel Information Reel Specifications for W Packing (13") and 7"

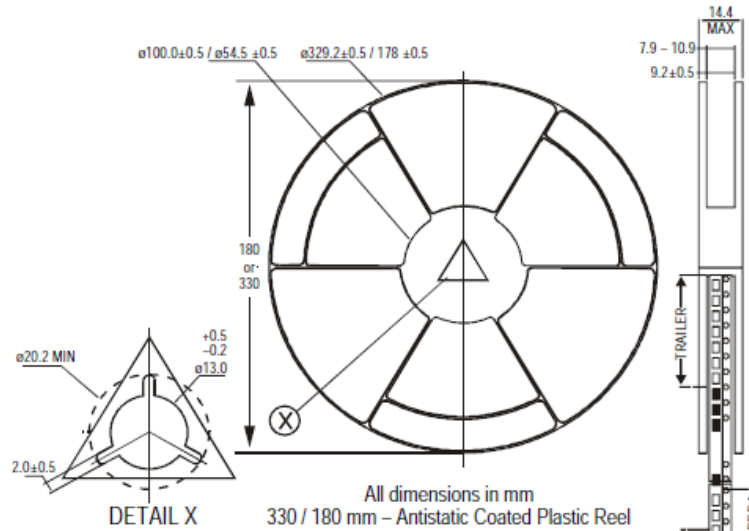

**NOTES:**

|                | 8mm Tape<br>Size of Reel   | 8mm Tape<br>Size of Reel |
|----------------|----------------------------|--------------------------|
| No. of Devices | 330 mm (13")<br>10,000 Pcs | 180 mm (7")<br>3,000 Pcs |

1. The bandolier of 330 mm reel contains at least 10,000 devices.
2. The bandolier of 180 mm reel contains at least 3,000 devices.
3. No more than 0.5% missing devices / reel. 50 empty compartments for 330 mm reel. 15 empty compartments for 180 mm reel.
4. Three consecutive empty places might be found provided this gap is followed by 6 consecutive devices.
5. The carrier tape (leader) starts with at least 75 empty positions (equivalent to 330 mm). In order to fix the carrier tape a self adhesive tape of 20 to 50 mm is applied. At the end of the bandolier at least 40 empty positions (equivalent to 160 mm) are there.

#### Tape Specification for SOT-23 Surface Mount Device

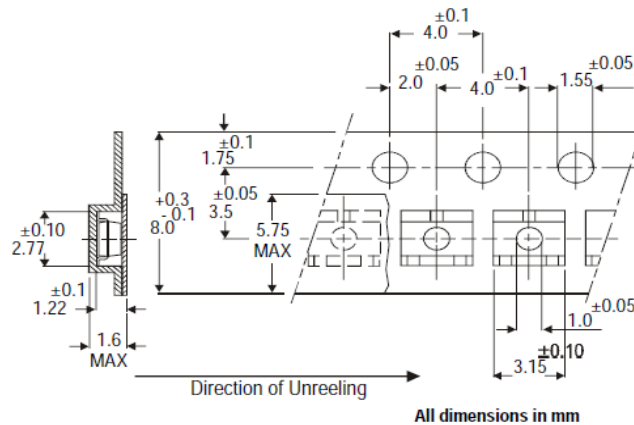

#### Packing Detail

| PACKAGE    | STANDARD PACK |                | INNER CARTON BOX |      | OUTER CARTON BOX  |       |        |
|------------|---------------|----------------|------------------|------|-------------------|-------|--------|
|            | Details       | Net Weight/Qty | Size             | Qty  | Size              | Qty   | Gr Wt  |
| SOT-23 T&R | 3K/reel       | 136 gm/3K pcs  | 3" x 7.5" x 7.5" | 12 K | 17" x 15" x 13.5" | 192 K | 12 kgs |
|            | 10K/reel      | 415 gm/10K pcs | 9" x 9" x 9"     | 51 K | 19" x 19" x 19"   | 408 K | 28 kgs |
|            |               |                | 13" x 13" x 0.5" | 10 K | 17" x 15" x 13.5" | 300 K | 16 kgs |



Continental Device India Pvt. Limited

An IATF 16949, ISO9001 and ISO 14001 Certified Company



### Recommended Product Storage Environment for Discrete Semiconductor Devices

This storage environment assumes that the Diodes and transistors are packed properly inside the original packing supplied by CDIL.

- Temperature 5 °C to 30 °C
- Humidity between 40 to 70 %RH
- Air should be clean.
- Avoid harmful gas or dust.
- Avoid outdoor exposure or storage in areas subject to rain or water spraying .
- Avoid storage in areas subject to corrosive gas or dust. Product shall not be stored in areas exposed to direct sunlight.
- Avoid rapid change of temperature.
- Avoid condensation.
- Mechanical stress such as vibration and impact shall be avoided.
- The product shall not be placed directly on the floor.
- The product shall be stored on a plane area. They should not be turned upside down. They should not be placed against the wall.

#### **Shelf Life of CDIL Products**

The shelf life of products is the period from product manufacture to shipment to customers. The product can be unconditionally shipped within this period. The period is defined as 2 years.

If products are stored longer than the shelf life of 2 years the products shall be subjected to quality check as per CDIL quality procedure.

The products are further warranted for another one year after the date of shipment subject to the above conditions in CDIL original packing.

#### **Floor Life of CDIL Products and MSL Level**

When the products are opened from the original packing, the floor life will start.

For this, the following JEDEC table may be referred:

| JEDEC MSL Level |                    |                 |
|-----------------|--------------------|-----------------|
| Level           | Time               | Condition       |
| 1               | Unlimited          | ≤30 °C / 85% RH |
| 2               | 1 Year             | ≤30 °C / 60% RH |
| 2a              | 4 Weeks            | ≤30 °C / 60% RH |
| 3               | 168 Hours          | ≤30 °C / 60% RH |
| 4               | 72 Hours           | ≤30 °C / 60% RH |
| 5               | 48 Hours           | ≤30 °C / 60% RH |
| 5a              | 24 Hours           | ≤30 °C / 60% RH |
| 6               | Time on Label(TOL) | ≤30 °C / 60% RH |



Continental Device India Pvt. Limited

An IATF 16949, ISO9001 and ISO 14001 Certified Company



## Customer Notes

### Component Disposal Instructions

1. CDIL Semiconductor Devices are RoHS compliant, customers are requested to please dispose as per prevailing Environmental Legislation of their Country.
2. In Europe, please dispose as per EU Directive 2002/96/EC on Waste Electrical and Electronic Equipment (WEEE).

### Disclaimer

The product information and the selection guides facilitate selection of the CDIL's Semiconductor Device(s) best suited for application in your product(s) as per your requirement. It is recommended that you completely review our Data Sheet(s) so as to confirm that the Device(s) meet functionality parameters for your application. The information furnished in the Data Sheet and on the CDIL Web Site/CD are believed to be accurate and reliable. CDIL however, does not assume responsibility for inaccuracies or incomplete information. Furthermore, CDIL does not assume liability whatsoever, arising out of the application or use of any CDIL product; neither does it convey any license under its patent rights nor rights of others. These products are not designed for use in life saving/support appliances or systems. CDIL customers selling these products (either as individual Semiconductor Devices or incorporated in their end products), in any life saving/support appliances or systems or applications do so at their own risk and CDIL will not be responsible for any damages resulting from such sale(s).

CDIL strives for continuous improvement and reserves the right to change the specifications of its products without prior notice.



CDIL is a registered trademark of

**Continental Device India Pvt. Limited**

C-120 Naraina Industrial Area, New Delhi 110 028, India.

Telephone +91-11-2579 6150, 4141 1112 Fax +91-11-2579 5290, 4141 1119

email@cdil.com www.cdil.com

CIN No. U32109DL1964PTC004291