



# 'Welcome on board'

## with our first Product Selection Guide under our new name - Phycomp

In the past you knew us as Philips Discrete Ceramics. Now our name has changed to Phycomp and we're part of the International Yageo Corporation – one of the world's top 3 suppliers of passives. Our new association combines all that was best within Philips, especially our innovative tradition and international service-oriented sales organization, with Yageo's massive manufacturing and financial resources.

For you, our customers, this means good news! It means in particular that the supply of innovative products and the support you've come to rely on from us will be assured in the years ahead. What's more, thanks to massive investments by Yageo, it also means major expansions in production capacity to meet your most demanding requirements.

### Supporting your innovative designs

In this catalogue you'll find our broad range of surface-mount discrete ceramic and integrated components. A range specifically created to support your innovative designs with functions such as RF filtering and tuning, impedance matching, line termination, signal delay, coupling and safety isolation.

### Many of our established products will no doubt be familiar to you. These include:

- A vast range of general purpose chip resistors (R-chips) and chip capacitors (MLCCs)
- High-frequency, low inductance and microwave MLCCs
- High-capacitance and high voltage MLCCs
- Feedthrough chip capacitors
- Thick and thin film chip resistors
- Precision chip resistors
- Power chip resistors
- Application-specific chip resistors including high ohmic, high voltage, surge and trimmable chip resistors.

As well as these established products, however, you'll also find our very latest developments including resistor arrays, capacitor arrays and RC networks. Developments offering major savings in board space, simplified circuit layout and easier assembly.

### The personal touch in passives

In our organization we've always prided ourselves on the support we offer our customers. We believe it's this *personal touch in passives* more than anything else that singles us out from our competitors. Promoting trust and mutual respect. What's more, through our heavy investments in global production we intend to ensure that this trust and respect between us is maintained, so that you will always know that you can count on our support, today and for the future.

For more information on our range of products listed here and about Phycomp, visit our web site on [www.phycomp-components.com](http://www.phycomp-components.com) where you can also find detailed contact information of our sales offices and distributor network.

# Table of contents

						Page
Introduction						3
Multilayer Ceramic Capacitors						6
General information						7
Program surveys						12
	TC code	Major features				
			Cap. range	Voltage range	Other	
	NPO	General purpose	0.47 pF to 22 nF	16 V to 100 V		12
		High voltage	3.3 pF to 5.6 nF	200 V to 4 kV		13
		Microwave	0.47 pF to 120 pF	50 V	3 GHz	14
		Narrow tolerance	0.47 pF to 22 nF	16 V to 50 V	1% or 0.1 pF	14
	X7R	General purpose	100 pF to 2.2 μF	10 V to 100 V		15
		High voltage	220 pF to 100 nF	200 V to 2 kV		16
		Low inductance	10 nF to 220 nF	16 V to 50 V	<600 pH	16
	Y5V and Z5U	General purpose	10 nF to 10 μF	10 V to 50 V		16
	NPO, X7R and Y5V	4-C arrays	10 pF to 100 nF	16 V to 50 V	4-fold	17
	NPO and X7R	Feedthrough capacitors	47 pF to 1 μF	16 V to 50 V		18
		Feedthrough 4-C arrays	47 pF to 10 nF	50 V	4-fold	18
	NPO and X7R	Ultra small MLCCs	1 pF to 3.3 nF	16 V to 50 V	smallest size	19
Product selection charts						
Discrete MLCCs						
	NPO	General purpose	270 pF to 3.3 nF	16 V		21
		General purpose	270 pF to 22 nF	25 V		22
		General purpose	0.47 pF to 22 nF	50 V		24
		General purpose	10 pF to 22 nF	100 V		26
		High voltage	10 pF to 5.6 nF	200 V and 500 V		28
		High voltage	3.3 pF to 1.5 nF	1 kV to 4 kV		30
		Microwave	0.47 pF to 120 pF	50 V	3 GHz	32
		Narrow tolerance	270 pF to 3.3 nF	16 V	1%	34
		Narrow tolerance	270 pF to 22 nF	25 V	1%	36
	X7R	Narrow tolerance	0.47 pF to 6.8 nF	50 V	1% or 0.1 pF	38
		General purpose	150 nF to 2.2 μF	10 V		40
		General purpose	100 pF to 1 μF	16 V to 100 V		42
		High voltage	220 pF to 100 nF	200 V and 500 V		44
		High voltage	470 pF to 10 nF	1 kV and 2 kV		46
	Y5V	Low inductance	10 nF to 220 nF	16 V to 50 V	<600 pH	47
		General purpose	1 μF to 10 μF	10 V		48
	Z5U	General purpose	10 nF to 4.7 μF	16 V to 50 V		50
		General purpose	10 nF to 1 μF	25 V and 50 V		52
4-C Arrays						
	NPO	4-C arrays	10 pF to 1 nF	50 V	4-fold	56
	X7R	4-C arrays	10 nF to 100 nF	16 V	4-fold	58
		4-C arrays	220 pF to 68 nF	25 V and 50 V	4-fold	60
	Y5V	4-C arrays	10 nF to 100 nF	25 V	4-fold	62
Discrete Feedthrough MLCCs						
	NPO	Feedthrough capacitors	47 pF to 1 nF	50 V		64
	X7R	Feedthrough capacitors	4.7 nF to 1 μF	16 V to 50 V		65
Feedthrough Arrays						
	NPO	Feedthrough 4-C arrays	47 pF to 470 pF	50 V	4-fold	66
	X7R	Feedthrough 4-C arrays	1 nF to 10 nF	50 V	4-fold	67
Ultra Small MLCCs						
	NPO	Ultra small MLCCs	1 pF to 22 pF	50 V	smallest size	68
	X7R	Ultra small MLCCs	47 pF to 3.3 nF	16 V to 50 V	smallest size	70
MLCC Sample Kits						72

# Table of contents

						Page
Fixed Resistors						79
General information						80
Program surveys						81
Product selection charts		Power	Resistance range	Voltage range	Tolerance	
General						
	General purpose and Precision	0.05 W to 0.25 W	1 $\Omega$ to 10 M $\Omega$	15 V to 200 V	1%, 5%	82
	High precision	0.063 W to 0.25 W	90 $\Omega$ to 2.74 M $\Omega$	50 V to 200 V	0.1%, 0.25%, 0.5%	83
	High precision – high stability	0.063 W, 0.125 W	100 $\Omega$ to 10 k $\Omega$	100 V	0.1%, 0.5%	84
	Arrays	0.063 W	10 $\Omega$ to 1 M $\Omega$	25 V, 50 V	1%, 5%	85
	R-Networks	0.031 W	10 $\Omega$ to 100 k $\Omega$	25 V	1%, 5%	86
	RC-network	0.063 W	10 $\Omega$ to 1 k $\Omega$	25 V	5%	86
Power						
	Power	0.5 W, 1.0 W	1 $\Omega$ to 10 M $\Omega$	200 V, 250 V	1%, 5%	87
	Power – low ohmic	0.5 W, 1.0 W	0.01 $\Omega$ to 0.976 $\Omega$	200 V, 250 V	1%, 5%	87
	Power – low ohmic – low TC	1.0 W	0.008 $\Omega$ to 0.100 $\Omega$	200 V, 250 V	1%, 5%	88
	High voltage	1.0 W	4.7 M $\Omega$ to 16 M $\Omega$	250 V	5%	88
Application specific						
	High voltage	0.25 W	100 k $\Omega$ to 27 M $\Omega$	400 V	1%, 5%	88
	High ohmic	0.1 W to 0.25 W	10 M $\Omega$ to 30 M $\Omega$	50 V to 200 V	5%	89
	Low ohmic	0.1 W to 0.25 W	0.02 $\Omega$ to 0.976 $\Omega$	150 V, 200 V	1%, 5%	89
	Trimmable	0.063 W to 0.25 W	1 $\Omega$ to 10 M $\Omega$	50 V to 200 V	5%	90
	Surge	0.25 W	1 $\Omega$ to 100 k $\Omega$	200 V	5%	90
	Fusible	0.063 W, 0.125 W	1 $\Omega$ to 510 M $\Omega$	50 V, 200 V	5%	90
	NiAu terminations	0.63 W, 0.25 W	1 $\Omega$ to 10 M $\Omega$	50 V, 200 V	1%, 5%	90
R-Chip Engineering Design Kits (Binders)						91

# Multilayer Ceramic Capacitors

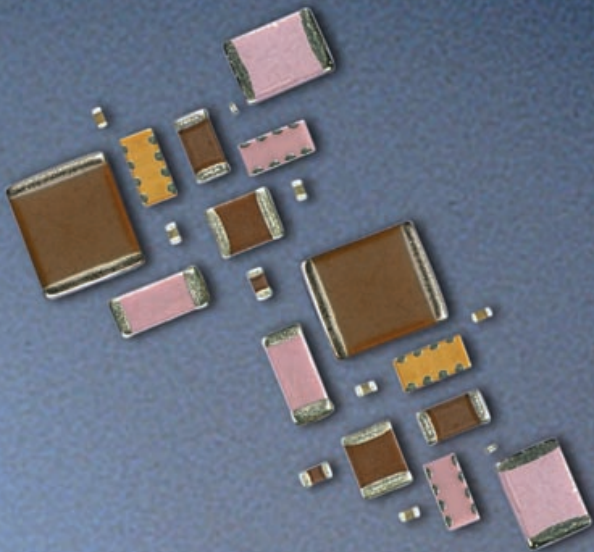

## Part numbering system and ordering

You can order components from this catalogue in two ways. Both ways give logistic and packing information.

- **Clear text ordering code (preferred)**  
This unique number is an easily-readable 15-digit code.
- **12-digit ordering code**  
This unique 12NC number forms the basis of the Phycomp logistic system.

You will find details for ordering in the *Ordering* section next to each selection chart.

Minimum shipment quantities, prices and delivery details can be obtained from the Phycomp sales organization in your country or from one of our franchised distributors.

## Case size codes

Throughout this catalogue, inch-based codes are used for the component sizes. According to IEC 60384-10, amendment 2 of Sept. 2000 for MLCCs, and IEC 60115-8, amendment 1 of July 2000 for R-chip, values for length and width should be in millimetres rather than in inches. To distinguish between inch-based codes and metric-based codes, metric-based codes will temporarily have the suffix "M". The table below shows the relation between inch-based case sizes versus the recommended metric case size designators.

Case size cross-reference	
Case size designation	
inch-based	Metric
0201	0603M
0402	1005M
0508	1220M
0603	1608M
0612	1632M
0805	2012M
1206	3216M
1210	3225M
1812	4532M

## Custom-design service

Besides the products listed in this catalogue, we also offer application-specific components and a custom-design service for customers with special requirements. Please consult our local representative if you require these services.

## NiSn versus AgPd terminations

Almost all our MLCCs are supplied with Ni-barrier terminations, but AgPd terminations can be supplied on request.

## Electrode technology

Two electrode technologies are currently used in Phycomp MLCCs:

- **Noble metal electrodes (NME)**, based on palladium with conventional ceramic materials.
- **Base metal electrodes (BME)**, a newer technology based on nickel. We plan to extend our BME product ranges.

## Water-based manufacturing process

Phycomp has recently introduced a revolutionary mass-manufacturing process for its Multilayer Chip Capacitors which is environment friendly, stable, safe and economical. The process produces ceramic sheets using a water-based binder instead of the conventional, potentially harmful solvent method.

In addition, a water-based electrode paste has been developed that achieves the same results as solvent-based pastes. This now means that Phycomp's MLCCs are free of all organic solvents.

Quick reference data		
Rated voltage	NP0 (CG)	16 V, 25 V, 50 V, 100 V, 500 V, 1 kV, 2 kV, 3 kV, 4 kV
	X7R (2R)	10 V, 16 V, 25 V, 50 V, 100 V, 200 V, 500 V, 1 kV, 3 kV
	Y5V (2F)	10 V, 16 V, 25 V, 50 V
	Z5U (2E)	25 V, 50 V
Tolerance	NP0 <10 pF	±0.1 pF, ±0.25 pF, ±0.5 pF
	NP0 ≥10 pF	±1%, ±2%, ±5%
	X7R	±5%, ±10%
	Y5V	±20%, -20 to +80%
	Z5U	±20%, -20 to +80%
Dissipation factor	NP0 <10 pF	≤10(3/C + 0.7)10 <sup>-4</sup> ; max. 30.10 <sup>-4</sup>
	NP0 ≥10 pF	≤10.10 <sup>-4</sup>
	X7R 10 V	≤5%
	X7R 16 V	≤3.5%
	X7R ≥25 V	≤2.5%
	Y5V 10 V	≤12.5%
	Y5V 16 V	≤9% or ≤12.5% depending on capacitance value
	Y5V ≥25 V	≤5% or ≤7% depending on capacitance value
	Z5U 16 V	≤9%
	Z5U 25 V	≤6%
Z5U 50 V	≤4%	
Temperature coefficient	NP0 16 V	0 ±60 ppm/K
	NP0 >16 V	0 ±30 ppm/K
Temperature characteristic	X7R	±15%
	Y5V	+22 to -82%
	Z5U	+22 to -56%
Climatic category	NP0	-55 to +125 °C
	X7R	-55 to +125 °C
	Y5V	-25 to +85 °C
	Z5U	+10 to +85 °C
Measuring conditions	NP0 <1000 pF	1 V, 1 MHz
	NP0 ≥1000 pF	1 V, 1 kHz
	X7R	1 V, 1 kHz
	Y5V	1 V, 1 kHz
	Z5U	0.5 V, 1 kHz

## Case dimensions

### Discrete capacitors

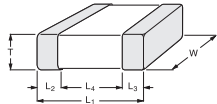

Case size designation		Dimensions in mm							
inch-based	Metric	L <sub>1</sub>	W	T <sub>min</sub>	T <sub>max</sub>	L <sub>2</sub> , L <sub>3min</sub>	L <sub>2</sub> , L <sub>3max</sub>	L <sub>4min</sub>	L <sub>4max</sub>
0201	0603M	0.6 ±0.03	0.3 ±0.03	0.27	0.33	0.10	0.20	0.20	0.20
0402	1005M	1.0 ±0.05	0.5 ±0.05	0.45	0.55	0.20	0.30	0.40	0.40
0603	1608M	1.6 ±0.10	0.8 ±0.07	0.73	0.87	0.20	0.60	0.40	0.40
0805	2012M	2.0 ±0.10	1.25 ±0.10	0.50	1.35	0.25	0.75	0.55	0.55
1206	3216M	3.2 ±0.15	1.6 ±0.15	0.50	1.75	0.25	0.75	1.40	1.40
1210	3225M	3.2 ±0.20	2.5 ±0.20	0.50	1.80	0.25	0.75	1.40	1.40
1812	4532M	4.5 ±0.20	3.2 ±0.20	0.50	1.80	0.25	0.75	2.20	2.20

Case size designation		Dimensions in inches							
inch-based	Metric	L <sub>1</sub>	W	T <sub>min</sub>	T <sub>max</sub>	L <sub>2</sub> , L <sub>3min</sub>	L <sub>2</sub> , L <sub>3max</sub>	L <sub>4min</sub>	L <sub>4max</sub>
0201	0603M	0.024 ±0.001	0.012 ±0.001	0.011	0.013	0.004	0.008	0.008	0.008
0402	1005M	0.040 ±0.002	0.020 ±0.002	0.018	0.022	0.008	0.012	0.016	0.016
0603	1608M	0.063 ±0.004	0.032 ±0.003	0.029	0.035	0.010	0.026	0.016	0.016
0805	2012M	0.079 ±0.004	0.049 ±0.004	0.020	0.053	0.010	0.030	0.022	0.022
1206	3216M	0.126 ±0.006	0.063 ±0.006	0.020	0.069	0.010	0.030	0.056	0.056
1210	3225M	0.126 ±0.008	0.098 ±0.008	0.020	0.072	0.010	0.030	0.056	0.056
1812	4532M	0.177 ±0.008	0.126 ±0.008	0.020	0.072	0.010	0.030	0.088	0.088

### Discrete capacitors (Low-inductance types only)

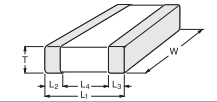

Case size designation		Dimensions in mm							
inch-based	Metric	L <sub>1</sub>	W	T <sub>min</sub>	T <sub>max</sub>	L <sub>2</sub> , L <sub>3min</sub>	L <sub>2</sub> , L <sub>3max</sub>	L <sub>4min</sub>	L <sub>4max</sub>
0508	1220M	1.25 ±0.20	2.0 ±0.20	0.75	0.95	0.13	0.46	0.38	0.38
0612	1632M	1.6 ±0.20	3.2 ±0.20	0.75	0.95	0.13	0.46	0.50	0.50

### Capacitor arrays

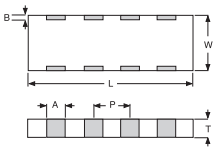

Case size designation		Dimensions in mm							
inch-based	Metric	L	W	T <sub>min</sub>	T <sub>max</sub>	A	B	P	P
0508 (4 x 0402)	1220M (4 x 0402)	2.0 ±0.15	1.25 ±0.15	0.50	0.70	0.28 ±0.10	0.2 ±0.10	0.5 ±0.10	0.5 ±0.10
0612 (4 x 0603)	1632M (4 x 0603)	3.2 ±0.15	1.6 ±0.15	0.50	1.20	0.4 ±0.10	0.3 ±0.20	0.8 ±0.10	0.8 ±0.10

### Feedthrough capacitors

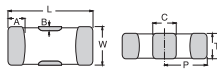

Case size designation		Dimensions in mm							
inch-based	Metric	L	W	T	A	B	C	P	P
1206	3216M	3.2 ±0.20	1.6 ±0.20	0.8 ±0.10	0.5 ±0.20	0.3 ±0.15	0.9 ±0.20	1.6 ±0.15	1.6 ±0.15

### Feedthrough capacitor arrays

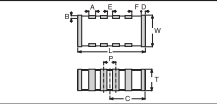

Case size designation		Dimensions in mm										
inch-based	Metric	L	W	T	A	B	C	D	E	F <sub>min</sub>	P	P
0612 (4 x 0603)	1632M (4 x 0603)	3.2	1.6	0.8	0.36	0.3	1.65	0.2	0.27	0.15	0.63	0.63
		±0.15	±0.15	±0.10	±0.10	±0.20	±0.15	±0.15	±0.10		±0.10	±0.10





# Phycomp's new range of high-capacitance MLCCs offers an attractive alternative to Tantalum capacitors

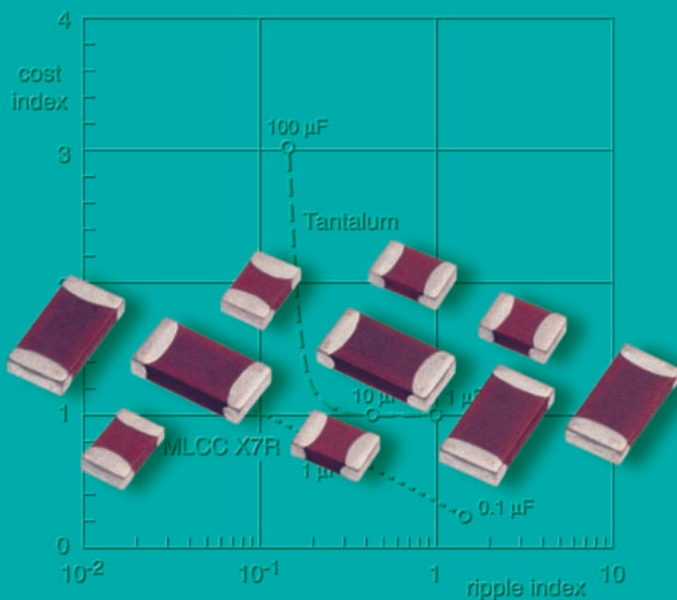

# Program survey

## NPO – General Purpose

NPO																			
Capacitance (pF)	General purpose																		
	16 V		25 V					50 V					100 V						
	0402	0603	0402	0603	0805	1206	1210	0402	0603	0805	1206	1210	1812	0603	0805	1206	1210	1812	
0.47																			
0.56																			
0.68																			
0.82																			
1.0																			
1.2																			
1.5																			
1.8																			
2.2																			
2.7																			
3.3																			
3.9																			
4.7																			
5.6																			
6.8																			
8.2																			
10																			
12																			
15																			
18																			
22																			
27																			
33																			
39																			
47																			
56																			
68																			
82																			
100																			
120																			
150																			
180																			
220																			
270																			
330																			
390																			
470																			
560																			
680																			
820																			
1 000																			
1 200																			
1 500																			
1 800																			
2 200																			
2 700																			
3 300																			
3 900																			
4 700																			
5 600																			
6 800																			
8 200																			
10 000																			
12 000																			
15 000																			
18 000																			
22 000																			

Note: Case size designators are inch-based; see General Information section for metric-based case size designators.

# Program survey

## NPO – High Voltage

NPO														
Capacitance (pF)	High voltage													
	200 V				500 V			1 kV		2 kV	3 kV		4 kV	
	0805	1206	1210	1812	1206	1210	1812	1206	1812	1206	1808	1812	1808	1812
3.3														
3.9														
4.7														
5.6														
6.8														
8.2														
10														
12														
15														
18														
22														
27														
33														
39														
47														
56														
68														
82														
100														
120														
150														
180														
220														
270														
330														
390														
470														
560														
680														
820														
1 000														
1 200														
1 500														
1 800														
2 200														
2 700														
3 300														
3 900														
4 700														
5 600														

Note: Case size designators are inch-based; see General Information section for metric-based case size designators.

# Program survey

## NPO – Microwave and Narrow Tolerance

NPO														
Capacitance (pF)	Microwave					Narrow tolerance								
	50 V			16 V		25 V					50 V			
	0603	0805	1206	0402	0603	0402	0603	0805	1206	1210	0402	0603	0805	1206
0.47														
0.56														
0.68														
0.82														
1.0														
1.2														
1.5														
1.8														
2.2														
2.7														
3.3														
3.9														
4.7														
5.6														
6.8														
8.2														
10														
12														
15														
18														
22														
27														
33														
39														
47														
56														
68														
82														
100														
120														
150														
180														
220														
270														
330														
390														
470														
560														
680														
820														
1 000														
1 200														
1 500														
1 800														
2 200														
2 700														
3 300														
3 900														
4 700														
5 600														
6 800														
8 200														
10 000														
12 000														
15 000														
18 000														
22 000														

Note: Case size designators are inch-based; see General Information section for metric-based case size designators.

# Program survey

## X7R – General Purpose

X7R																						
Capacitance (pF)	General purpose																					
	10 V			16 V				25 V					50 V					100 V				
	0603	0805	1206	0402	0603	0805	1206	0402	0603	0805	1206	1210	0402	0603	0805	1206	1210	1812	0805	1206	1210	1812
100																						
150																						
220																						
330																						
470																						
680																						
1 000																						
1 500																						
2 200																						
3 300																						
4 700																						
6 800																						
10 000																						
15 000																						
22 000																						
33 000																						
47 000																						
68 000																						
100 000																						
150 000																						
220 000																						
330 000																						
470 000																						
680 000																						
1 000 000																						
1 500 000																						
2 200 000																						

Note: Case size designators are inch-based; see General Information section for metric-based case size designators.

# Program survey

## X7R – High Voltage and Low Inductance

X7R															
Capacitance (pF)	High voltage												Low inductance		
	200 V				500 V			1 kV			2 kV		16 V	25 V	50 V
	0805	1206	1210	1812	1206	1210	1812	1206	1808	1812	1808	1812	0508	0508	0612
220															
330															
470															
680															
1 000															
1 500															
2 200															
3 300															
4 700															
6 800															
10 000															
15 000															
22 000															
33 000															
47 000															
68 000															
100 000															
150 000															
220 000															

Note: Case size designators are inch-based; see General Information section for metric-based case size designators.

## Y5V and Z5U – General Purpose

Y5V and Z5U																		
Capacitance (pF)	General purpose																	
	Class-2 Y5V												Class-2 Z5U					
	10 V			16 V			25 V			50 V			25 V		50 V			
	0603	0805	1206	0402	0603	0805	1206	0603	0805	1206	0603	0805	1206	0603	1206	0805	1206	1210
10 000																		
22 000																		
47 000																		
100 000																		
220 000																		
470 000																		
1 000 000																		
2 200 000																		
4 700 000																		
10 000 000																		

Note: Case size designators are inch-based; see General Information section for metric-based case size designators.

# Program survey

## NP0, X7R and Y5V – 4-C Arrays

NP0, X7R and Y5V								
Capacitance (pF)	4-C arrays							
	NP0		X7R					Y5V
	50 V		16 V	25 V	50 V		25 V	
	0508 (4 x 0402)	0612 (4 x 0603)	0508 (4 x 0402)	0612 (4 x 0603)	0612 (4 x 0603)	0612 (4 x 0603)	0508 (4 x 0402)	0612 (4 x 0603)
10								
12								
15								
18								
22								
27								
33								
39								
47								
56								
68								
82								
100								
120								
150								
180								
220								
270								
330								
390								
470								
560								
680								
820								
1 000								
1 200								
1 500								
1 800								
2 200								
2 700								
3 300								
3 900								
4 700								
5 600								
6 800								
8 200								
10 000								
12 000								
15 000								
18 000								
22 000								
27 000								
33 000								
39 000								
47 000								
56 000								
68 000								
82 000								
100 000								

**Note:** Case size designators are inch-based; see General Information section for metric-based case size designators.



# Program survey

## NP0 and X7R – Feedthrough Capacitors and 4-C Arrays

NP0 and X7R						
Capacitance (pF)	Feedthrough capacitors and 4-C arrays					
	Feedthrough capacitors				4-C arrays	
	NP0	X7R			NP0	X7R
	50 V	16 V	25 V	50 V	50 V	50 V
1206	1206	1206	1206	0612 (4 x 0603)	0612 (4 x 0603)	
47						
68						
100						
150						
220						
330						
470						
680						
1 000						
1 500						
2 200						
3 300						
4 700						
6 800						
10 000						
15 000						
22 000						
33 000						
47 000						
68 000						
100 000						
680 000						
1 000 000						

Note: Case size designators are inch-based; see General Information section for metric-based case size designators.

# Program survey

## NP0, X7R and Y5V – Ultra Small MLCCs

NP0, X7R and Y5V				
Ultra small MLCCs				
Capacitance (pF)	NP0	X7R		
	50 V	16 V	25 V	50 V
	0201	0201	0201	0201
1.0				
1.2				
1.5				
1.8				
2.2				
2.7				
3.3				
3.9				
4.7				
5.6				
6.8				
8.2				
10				
12				
15				
18				
22				
27				
33				
39				
47				
56				
68				
82				
100				
120				
150				
180				
220				
270				
330				
390				
470				
560				
680				
820				
1 000				
1 200				
1 500				
1 800				
2 200				
2 700				
3 300				

**Note:** Case size designators are inch-based; see General Information section for metric-based case size designators.

Phycomp's new high-voltage MLCC range is ideal for power applications in, for example, SMPS, DC-DC converters and DC-AC converters

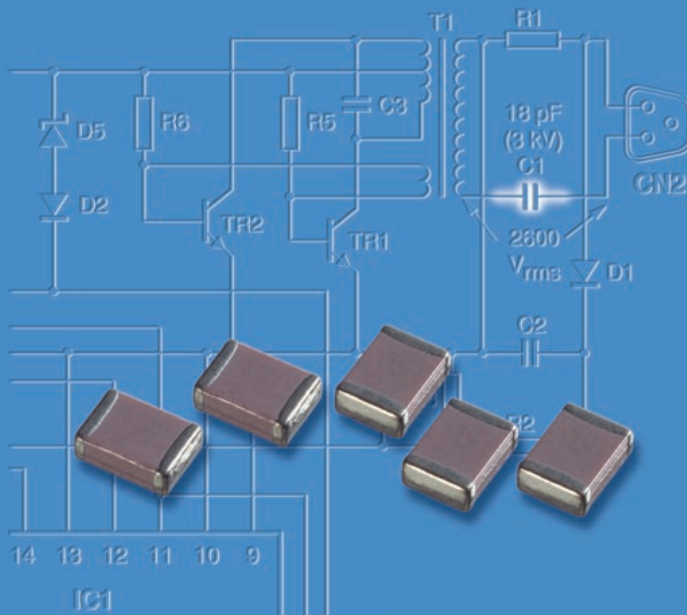

# Product selection chart

## NPO – 16 V, General Purpose

NPO - 16 V			
General purpose			
Capacitance (pF)	Last two digits of 12NC	0402	0603
270	42	0.5 ±0.05	
330	43		
390	44		
470	45		
560	-		
680	-	0.8 ±0.07	
820	-		
1 000	-		
1 200	-		
1 500	-		
1 800	53	0.8 ±0.07	
2 200	54		
2 700	55		
3 300	56		
Tape width		8 mm	

**Note 1:** Case size designators are inch-based; see General Information section for metric-based case size designators.

**Note 2:** Values in shaded cells indicate thickness class.

### Thickness classes and packing quantities

Thickness class (mm)	8 mm tape width quantity per reel		Quantity per bulk case	
	180 mm / 7"	330 mm / 13"	0402	0603
	Paper	Paper		
0.5 ±0.05	10 000	50 000	50 000	-
0.8 ±0.07	4 000	15 000	-	15 000

### Ordering information

Clear text code (preferred)

0603CH271J7B200 (example)

0603	CH	271	J	7	B	2	0	0
Size code	Temp. char.	Cap. in pF	Tolerance	Voltage	Termination	Packing	Marking	Range identifier
0402 0603	CH = NPO	271 = 270 pF The third digit signifies the multiplying factor: 1 = x 10 2 = x 100	G = ±2% J = ±5%	7 = 16 V	B = NiSn	2 = 180 mm / 7" paper 3 = 330 mm / 13" paper P = bulk case	0 = no marking	0 = conv. ceramic

### Ordering code 12NC

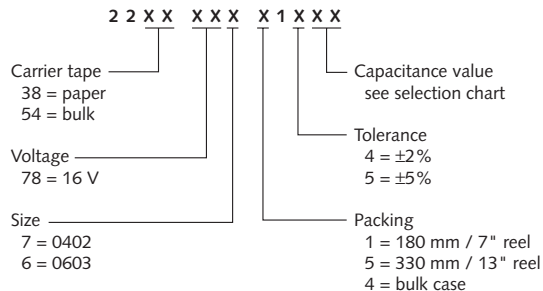

# Product selection chart

## NP0 – 25 V, General Purpose

NP0 - 25 V						
General purpose						
Capacitance (pF)	Last two digits of 12NC	0402	0603	0805	1206	1210
270	42	0.5 ±0.05				
330	-					
390	-					
470	-					
560	-					
680	-					
820	48					
1 000	49		0.8 ±0.07			
1 200	51					
1 500	52					
1 800	-					
2 200	-					
2 700	-					
3 300	56			0.85 ±0.1		
3 900	57					
4 700	58			1.25 ±0.1		
5 600	-					
6 800	-					
8 200	62				0.85 ±0.1	
10 000	63					
12 000	64					0.5 to 1.0
15 000	65					
18 000	66					
22 000	67					0.9 to 1.3
Tape width				8 mm		

**Note 1:** Case size designators are inch-based; see General Information section for metric-based case size designators.  
**Note 2:** Values in shaded cells indicate thickness class.

# Product selection chart

## NPO – 25 V, General Purpose

Thickness classes and packing quantities							
Thickness class (mm)	8 mm tape width quantity per reel				Quantity per bulk case		
	180 mm / 7"	180 mm / 7"	330 mm / 13"	330 mm / 13"			
	Paper	Blister	Paper	Blister	0402	0603	0805
0.5 ±0.05	10 000	-	50 000	-	50 000	-	-
0.8 ±0.07	4 000	-	15 000	-	-	15 000	-
0.85 ±0.1	4 000	-	15 000	-	-	-	8 000
0.5 to 1.0	-	4 000	-	10 000	-	-	-
0.9 to 1.3	-	3 000	-	10 000	-	-	-
1.25 ±0.1	-	3 000	-	10 000	-	-	5 000

Ordering information								
Clear text code (preferred)								
0603CG102J8B200 (example)								
0603	CG	102	J	8	B	2	0	0
Size code	Temp. char.	Cap. in pF	Tolerance	Voltage	Termination	Packing	Marking	Range identifier
0402	CG = NPO	102 = 1000 pF	G = ±2%	8 = 25 V	B = NiSn	2 = 180 mm / 7" paper	0 = no marking	0 = conv. ceramic
0603		The third digit	J = ±5%			3 = 330 mm / 13" paper		
0805		signifies the				B = 180 mm / 7" blister		
1206		multiplying				F = 330 mm / 13" blister		
1210		factor:				P = bulk case		
		1 = x 10						
		2 = x 100						
		3 = x 1000						

Ordering code 12NC	
<p>2 2 X X X X X X X X X X</p> <p>Carrier tape 22 = blister 38 = paper 54 = bulk</p> <p>Voltage 91 = 25 V</p> <p>Size 7 = 0402 6 = 0603 0 = 0805 1 = 1206 2 = 1210</p>	<p>Capacitance value see selection chart</p> <p>Tolerance 4 = ±2% 5 = ±5%</p> <p>Packing 1 = 180 mm / 7" reel 5 = 330 mm / 13" reel 4 = bulk case</p>

# Product selection chart

## NPO – 50 V, General Purpose

NPO - 50 V							
General purpose							
Capacitance (pF)	Last three digits of 12NC	0402	0603	0805	1206	1210	1812
0.47	477						
0.56	567						
0.68	687						
0.82	827						
1.0	108						
1.2	128						
1.5	158						
1.8	188						
2.2	228						
2.7	278						
3.3	338						
3.9	398						
4.7	478						
5.6	568						
6.8	688						
8.2	828						
10	109	0.5 ±0.05	0.8 ±0.07	0.6 ±0.1	0.6 ±0.1		
12	129						
15	159						
18	189						
22	229						
27	279						
33	339						
39	399						
47	479						
56	569						
68	689						
82	829						
100	101						
120	121						
150	151						
180	181						
220	221						
270	271						
330	331						
390	391						
470	471						
560	561						
680	681						
820	821						
1 000	102						
1 200	122						
1 500	152			0.85 ±0.1			
1 800	182						
2 200	222						
2 700	272			1.25 ±0.1			
3 300	332						
3 900	392				0.85 ±0.1	0.5 to 1.0	0.5 to 1.0
4 700	472						
5 600	562						
6 800	682				1.15 ±0.1		
8 200	822						
10 000	103						
12 000	123						
15 000	153						
18 000	183						
22 000	223						0.9 to 1.3
Tape width		8 mm				12 mm	

**Note 1:** Case size designators are inch-based; see General Information section for metric-based case size designators.

**Note 2:** Values in shaded cells indicate thickness class.

# Product selection chart

## NPO – 50 V, General Purpose

Thickness classes and packing quantities								
Thickness class (mm)	8 mm tape width quantity per reel				12 mm tape width quantity per reel	Quantity per bulk case		
	180 mm / 7"	180 mm / 7"	330 mm / 13"	330 mm / 13"	180 mm / 7" blister			
	Paper	Blister	Paper	Blister	1812	0402	0603	0805
0.5 ±0.05	10 000	-	50 000	-	-	50 000	-	-
0.6 ±0.1	4 000	-	20 000	-	-	-	-	10 000
0.8 ±0.07	4 000	-	15 000	-	-	-	15 000	-
0.85 ±0.1	4 000	-	15 000	-	-	-	-	8 000
0.5 to 1.0	-	4 000	-	10 000	2 000	-	-	-
0.9 to 1.3	-	3 000	-	10 000	1 500	-	-	-
1.15 ±0.1	-	3 000	-	10 000	-	-	-	-
1.25 ±0.1	-	3 000	-	10 000	-	-	-	5 000

Ordering information								
Clear text code (preferred)								
0805CG102J9B200 (example)								
0805	CG	102	J	9	B	2	0	0
Size code	Temp. char.	Cap. in pF	Tolerance	Voltage	Termination	Packing	Marking	Range identifier
0402	CG = NPO	102 = 1000 pF	C = ±0.25 pF	9 = 50 V	B = NiSn	2 = 180 mm / 7" paper 3 = 330 mm / 13" paper B = 180 mm / 7" blister F = 330 mm / 13" blister P = bulk	0 = no marking	0 = conv. ceramic
0603		The third digit signifies the multiplying factor: 8 = x 0.01 9 = x 0.1 0 = x 1 1 = x 10 2 = x 100 3 = x 1000	D = ±0.5 pF					
0805			G = ±2%					
1206			J = ±5%					
1210								
1812								

Ordering code 12NC	
2 2 X X X X X X X X X X	
Carrier tape 22 = blister 38 = paper 54 = bulk	Capacitance value see selection chart
Voltage 86 = 50 V	Tolerance 4 = ±0.25 pF for C = 5.6 to 8.2 pF ±2% for C ≥10 pF 5 = ±0.25 pF for C = 0.47 to 4.7 pF ±0.5 pF for C = 5.6 to 8.2 pF ±5% for C ≥10 pF
Size 9 = 0402 7 = 0603 1 = 0805 3 = 1206 2 = 1210 5 = 1812	Packing 1 = 180 mm / 7" reel 7 = 330 mm / 13" reel 4 = bulk case



# Product selection chart

## NPO – 100 V, General Purpose

NPO - 100 V							
General purpose							
Capacitance (pF)	Last two digits of 12NC	0603	0805	1206	1210	1812	
10	23						
12	24						
15	25						
18	26						
22	27						
27	28						
33	29						
39	31						
47	32						
56	33						
68	34						
82	35						
100	36						
120	37	0.8 ±0.07	0.6 ±0.1	0.6 ±0.1			
150	38						
180	39						
220	41						
270	42						
330	43						
390	44						
470	45						
560	46						
680	47						
820	48						
1 000	49						
1 200	51						
1 500	52		0.85 ±0.1				
1 800	53						
2 200	54		1.25 ±0.1				
2 700	55						
3 300	56						
3 900	57			0.85 ±0.1			
4 700	58						
5 600	59			1.15 ±0.1			
6 800	61						
8 200	62				0.5 to 1.0		
10 000	63						
12 000	64					0.5 to 1.0	
15 000	65						
18 000	66					0.9 to 1.3	
22 000	67						
Tape width		8 mm				12 mm	

**Note 1:** Case size designators are inch-based; see General Information section for metric-based case size designators.  
**Note 2:** Values in shaded cells indicate thickness class.

# Product selection chart

## NPO – 100 V, General Purpose

Thickness classes and packing quantities							
Thickness class (mm)	8 mm tape width quantity per reel				12 mm tape width quantity per reel	Quantity per bulk case	
	180 mm / 7"	180 mm / 7"	330 mm / 13"	330 mm / 13"	180 mm / 7"		
	Paper	Blister	Paper	Blister	1812	0603	0805
0.6 ±0.1	4 000	-	20 000	-	-	-	10 000
0.8 ±0.07	4 000	-	15 000	-	-	15 000	-
0.85 ±0.1	4 000	-	15 000	-	-	-	8 000
0.5 to 1.0	-	4 000	-	10 000	2 000	-	-
0.9 to 1.3	-	3 000	-	10 000	1 500	-	-
1.15 ±0.1	-	3 000	-	10 000	-	-	-
1.25 ±0.1	-	3 000	-	10 000	-	-	5 000

### Ordering information

Clear text code (preferred)

0805CG102G0B200 (example)

0805	CG	102	G	0	B	2	0	0
Size code	Temp. char.	Cap. in pF	Tolerance	Voltage	Termination	Packing	Marking	Range identifier
0603	CG = NPO	102 = 1000 pF	G = ±2%	0 = 100 V	B = NiSn	2 = 180 mm / 7" paper	0 = no marking	0 = conv. ceramic
0805		The third digit	J = ±5%			3 = 330 mm / 13" paper		
1206		signifies the				B = 180 mm / 7" blister		
1210		multiplying				F = 330 mm / 13" blister		
1812		factor:				P = bulk case		
		0 = x 0						
		1 = x 10						
		2 = x 100						
		3 = x 1000						

### Ordering code 12NC

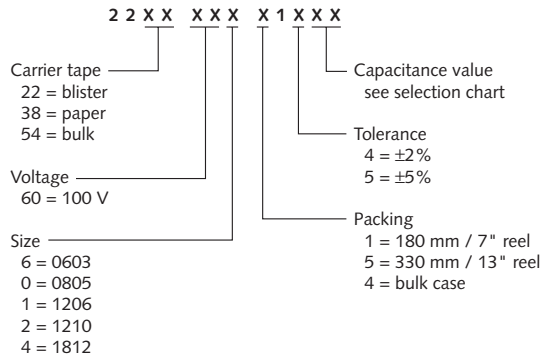

# Product selection chart

## NPO – 200 V and 500 V, High Voltage

NPO - 200 V and 500 V								
High voltage								
Capacitance (pF)	Last two digits of 12NC	200 V				500 V		
		0805	1206	1210	1812	1206	1210	1812
10	23							
12	24							
15	25							
18	26							
22	27							
27	28							
33	29							
39	31	0.6 ±0.1	0.6 ±0.1			0.6 ±0.1		
47	32							
56	33							
68	34							
82	35							
100	36							
120	37							
150	38							
180	39							
220	41							
270	42					0.85 ±0.1	0.8 to 1.0	
330	43	0.85 ±0.1	0.85 ±0.1			0.85 ±0.1	0.8 to 1.0	
390	44							
470	45							
560	46	1.25 ±0.1						
680	47					1.15 ±0.1		
820	48							
1 000	49							
1 200	51						0.9 to 1.3	
1 500	52		1.15 ±0.1					
1 800	53			0.8 to 1.0			1.2 to 1.75	
2 200	54							
2 700	55			0.9 to 1.3				0.9 to 1.3
3 300	56							
3 900	57				0.8 to 1.0			
4 700	58					0.9 to 1.3		
5 600	59							
Tape width		8 mm			12 mm	8 mm		12 mm

**Note 1:** Case size designators are inch-based; see General Information section for metric-based case size designators.

**Note 2:** Values in shaded cells indicate thickness class.

# Product selection chart

## NPO – 200 V and 500 V, High Voltage

Thickness classes and packing quantities						
Thickness class (mm)	8 mm tape width quantity per reel				12 mm tape width quantity per reel	Quantity per bulk case
	180 mm / 7"	180 mm / 7"	330 mm / 13"	330 mm / 13"	180 mm / 7" blister	
	Paper	Blister	Paper	Blister	1812	
0.6 ±0.1	4 000	-	20 000	-	-	10 000
0.85 ±0.1	4 000	-	15 000	-	-	8 000
0.8 to 1.0	-	4 000	-	10 000	2 000	-
0.9 to 1.3	-	3 000	-	10 000	1 500	-
1.15 ±0.1	-	3 000	-	10 000	-	-
1.25 ±0.1	-	3 000	-	10 000	-	5 000
1.2 to 1.75	-	2 500	-	10 000	1 200	-

### Ordering information

Clear text code (preferred)

1206CG102GBB200 (example)

1206	CG	102	G	B	B	2	0	0
Size code	Temp. char.	Cap. in pF	Tolerance	Voltage	Termination	Packing	Marking	Range identifier
0805 1206 1210 1812	CG = NPO	102 = 1000 pF The third digit signifies the multiplying factor: 0 = x 1 1 = x 10 2 = x 100 3 = x 1000	G = ±2% J = ±5%	B = 200 V D = 500 V	B = NiSn	2 = 180 mm / 7" paper 3 = 330 mm / 13" paper B = 180 mm / 7" blister F = 330 mm / 13" blister P = bulk case	0 = no marking	0 = conv. ceramic

### Ordering code 12NC

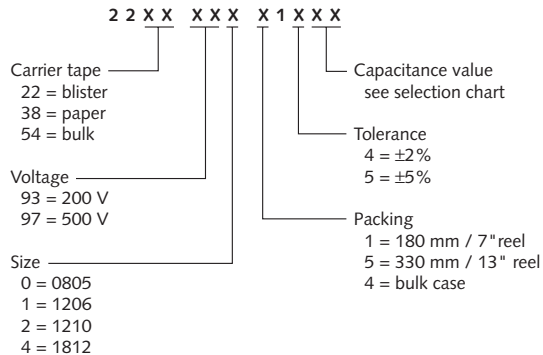

# Product selection chart

## NP0 – 1 kV to 4 kV, High Voltage

NP0 - 1 kV to 4 kV								
High voltage								
Capacitance (pF)	Last two digits of 12NC	1 kV		2 kV	3 kV		4 kV	
		1206	1812	1206	1808	1812	1808	1812
3.3	17							
3.9	18							
4.7	19							
5.6	20							
6.8	21							
8.2	22							
10	23							
12	24							
15	25						1.2 to 1.75	1.2 to 1.75
18	26							
22	27							
27	28							
33	29							
39	31			0.9 to 1.3	0.9 to 1.3	0.9 to 1.3		
47	32							
56	33							
68	34							
82	35							
100	36							
120	37							
150	38							
180	39							
220	41	0.9 to 1.3	0.5 to 1.0					
270	42							
330	43							
390	44							
470	45							
560	46							
680	47							
820	48							
1 000	49							
1 200	51		0.9 to 1.3					
1 500	52							
Tape width		8 mm	12 mm	8 mm			12 mm	

Note 1: Case size designators are inch-based; see General Information section for metric-based case size designators.

Note 2: Values in shaded cells indicate thickness class.

# Product selection chart

## NPO – 1 kV to 4 kV, High Voltage

Thickness classes and packing quantities				
Thickness class (mm)	8 mm tape width quantity per reel		12 mm tape width quantity per reel	
	180 mm / 7" blister		180 mm / 7" blister	
0.5 to 1.0	1206		1808	1812
0.9 to 1.3	-		-	2 000
1.2 to 1.75	3 000		1 500	1 500
	-		1 000	1 000

### Ordering information

Clear text code (preferred)

1206CG220JFB800 (example)

1206	CG	220	J	F	B	B	0	0
Size code	Temp. char.	Cap. in pF	Tolerance	Voltage	Termination	Packing	Marking	Range identifier
1206 1808 1812	CG = NPO	220 = 22 pF The third digit signifies the multiplying factor: 0 = x 1 1 = x 10 2 = x 100	J = ±5%	E = 1 kV F = 2 kV G = 3 kV H = 4 kV	B = NiSn	B = 180 mm / 7" blister	0 = no marking	0 = conv. ceramic

### Ordering code 12NC

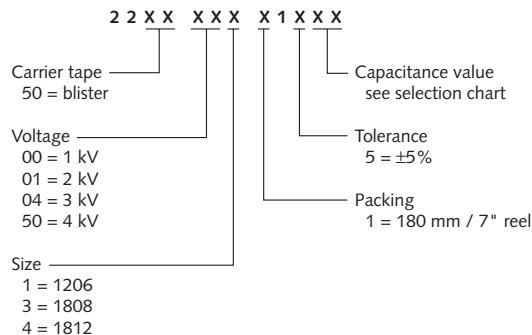

# Product selection chart

## NP0 – 50 V, Microwave

NP0 - 50 V				
Microwave				
Capacitance (pF)	Last two digits of 12NC	0603	0805	1206
0.47	05			
0.56	06			
0.68	07			
0.82	08			
1.0	09			
1.2	11			
1.5	12			
1.8	13			
2.2	14			
2.7	15			
3.3	16			
3.9	17	0.8 ±0.07	0.6 ±0.1	0.6 ±0.1
4.7	18			
5.6	19			
6.8	21			
8.2	22			
10	23			
12	24			
15	25			
18	26			
22	27			
27	28			
33	29			
39	31			
47	32			
56	33			
68	34			
82	35			
100	36			
120	37			
Tape width		8 mm		

**Note 1:** Case size designators are inch-based; see General Information section for metric-based case size designators.  
**Note 2:** Values in shaded cells indicate thickness class.

# Product selection chart

## NPO – 50 V, Microwave

Thickness classes and packing quantities				
Thickness class (mm)	8 mm tape width quantity per reel		Quantity per bulk case	
	180 mm / 7"	330 mm / 13"		
	Paper	Paper	0603	0805
0.6 ±0.1	4 000	20 000	-	10 000
0.8 ±0.07	4 000	15 000	15 000	-

Ordering information								
Clear text code (preferred)								
0805CG100G9B20M (example)								
0805	CG	100	G	9	B	2	0	M
Size code	Temp. char.	Cap. in pF	Tolerance	Voltage	Termination	Packing	Marking	Range identifier
0603 0805 1206	CG = NPO	100 = 100 pF The third digit signifies the multiplying factor: 8 = x 0.01 9 = x 0.1 0 = x 1 1 = x 10	B = ±0.1 pF C = ±0.25 pF D = ±0.5 pF F = ±1% G = ±2% J = ±5%	9 = 50 V	B = NiSn	2 = 180 mm / 7" paper 3 = 330 mm / 13" paper P = bulk case	0 = no marking	M = microwave

Ordering code 12NC	
<p>2 2 X X X X X X X 1 X X X X</p> <p>Carrier tape 38 = paper 54 = bulk</p> <p>Size 578 = 0603 574 = 0805 576 = 1206</p>	<p>Capacitance value see selection chart</p> <p>Tolerance 0 = ±0.1 pF for C &lt;10 pF 1 = ±0.25 pF for C &lt;10 pF 2 = ±0.5 pF for 5 pF ≤ C &lt;10 pF 3 = ±1% for C ≥10 pF 4 = ±2% for C ≥10 pF 5 = ±5% for C ≥10 pF</p> <p>Packing 1 = 180 mm / 7" reel 5 = 330 mm / 13" reel 4 = bulk case</p>



# Product selection chart

## NP0 – 16 V, Narrow Tolerance

NP0 - 16 V			
Narrow tolerance			
Capacitance (pF)	Last two digits of 12NC	0402	0603
270	42		
330	43		
390	44	0.5 ±0.05	
470	45		
560	-		
680	-		
820	-		
1 000	-		
1 200	-		
1 500	-		
1 800	53		
2 200	54		0.8 ±0.07
2 700	55		
3 300	56		
Tape width			8 mm

**Note 1:** Case size designators are inch-based; see General Information section for metric-based case size designators.  
**Note 2:** Values in shaded cells indicate thickness class.

# Product selection chart

## NPO – 16 V, Narrow Tolerance

Thickness classes and packing quantities				
Thickness class (mm)	8 mm tape width quantity per reel		Quantity per bulk case	
	180 mm / 7"	330 mm / 13"		
	Paper	Paper	0402	0603
0.5 ±0.05	10 000	50 000	50 000	-
0.8 ±0.07	4 000	15 000	-	15 000

### Ordering information

Clear text code (preferred)

0603CH271J7B200 (example)

0603	CH	271	J	7	B	2	0	0
Size code	Temp. char.	Cap. in pF	Tolerance	Voltage	Termination	Packing	Marking	Range identifier
0402 0603	CH = NPO	271 = 270 pF The third digit signifies the multiplying factor: 1 = x 10 2 = x 100	F = ±1%	7 = 16 V	B = NiSn	2 = 180 mm / 7" paper 3 = 330 mm / 13" paper P = bulk case	0 = no marking	0 = conv. ceramic

### Ordering code 12NC

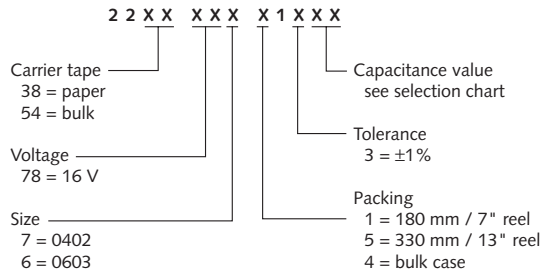

# Product selection chart

## NP0 – 25 V, Narrow Tolerance

NP0 - 25 V						
Narrow tolerance						
Capacitance (pF)	Last two digits of 12NC	0402	0603	0805	1206	1210
270	42	0.5 ±0.05				
330	-					
390	-					
470	-					
560	-					
680	-					
820	48					
1 000	49		0.8 ±0.07			
1 200	51					
1 500	52					
1 800	-					
2 200	-					
2 700	-					
3 300	56			0.85 ±0.1		
3 900	57			1.25 ±0.1		
4 700	58					
5 600	-					
6 800	-					
8 200	62				0.85 ±0.1	
10 000	63					
12 000	64					
15 000	65					0.5 to 1.0
18 000	66					
22 000	67					0.9 to 1.3
Tape width		8 mm				

**Note 1:** Case size designators are inch-based; see General Information section for metric-based case size designators.  
**Note 2:** Values in shaded cells indicate thickness class.

# Product selection chart

## NP0 – 25 V, Narrow Tolerance

Thickness classes and packing quantities							
Thickness class (mm)	8 mm tape width quantity per reel				Quantity per bulk case		
	180 mm / 7"	180 mm / 7"	330 mm / 13"	330 mm / 13"			
	Paper	Blister	Paper	Blister	0402	0603	0805
0.5 ±0.05	10 000	-	50 000	-	50 000	-	-
0.8 ±0.07	4 000	-	15 000	-	-	15 000	-
0.85 ±0.1	4 000	-	15 000	-	-	-	8 000
0.5 to 1.0	-	4 000	-	10 000	-	-	-
0.9 to 1.3	-	3 000	-	10 000	-	-	-
1.25 ±0.1	-	3 000	-	10 000	-	-	5 000

Ordering information								
Clear text code (preferred)								
0603CG102J8B200 (example)								
0603	CG	102	J	8	B	2	0	0
Size code	Temp. char.	Cap. in pF	Tolerance	Voltage	Termination	Packing	Marking	Range identifier
0402 0603 0805 1206 1210	CG = NP0	102 = 1 000 pF The third digit signifies the multiplying factor: 1 = x 10 2 = x 100 3 = x 1000	F = ±1%	8 = 25 V	B = NiSn	2 = 180 mm / 7" paper 3 = 330 mm / 13" paper B = 180 mm / 7" blister F = 330 mm / 13" blister P = bulk case	0 = no marking	0 = conv. ceramic

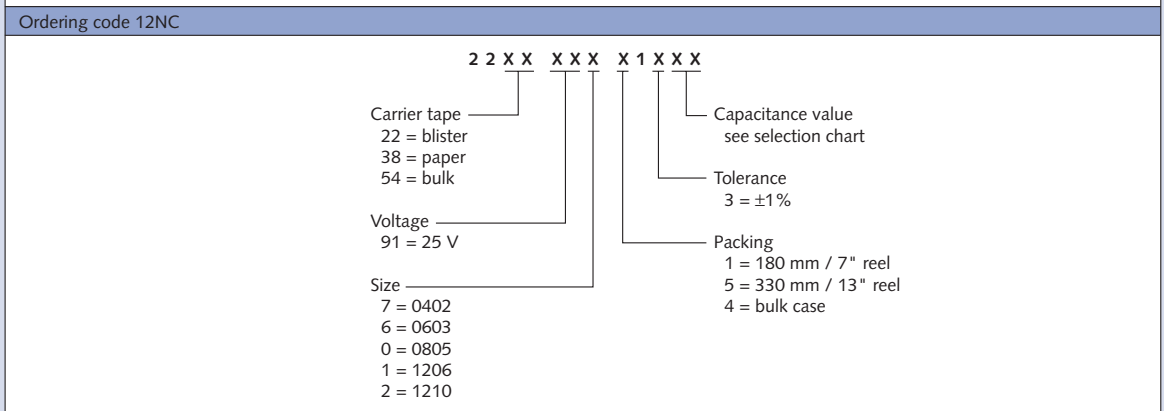

# Product selection chart

## NPO – 50 V, Narrow Tolerance

NPO - 50 V					
Narrow tolerance					
Capacitance (pF)	Last three digits of 12NC	0402	0603	0805	1206
0.47	477				
0.56	567				
0.68	687				
0.82	827				
1.0	108				
1.2	128				
1.5	158				
1.8	188				
2.2	228				
2.7	278				
3.3	338				
3.9	398				
4.7	478	0.5 ±0.05	0.8 ±0.07	0.6 ±0.1	0.6 ±0.1
5.6	568				
6.8	688				
8.2	828				
10	109				
12	129				
15	159				
18	189				
22	229				
27	279				
33	339				
39	399				
47	479				
56	569				
68	689				
82	829				
100	101				
120	121				
150	151				
180	181				
220	221				
270	271				
330	331				
390	391				
470	471				
560	561				
680	681				
820	821				
1 000	102				
1 200	122				
1 500	152			0.85 ±0.1	
1 800	182				
2 200	222				
2 700	272			1.25 ±0.1	
3 300	332				
3 900	392				0.85 ±0.1
4 700	472				
5 600	562				
6 800	682				1.15 ±0.1
Tape width		8 mm			
<b>Note 1:</b> Case size designators are inch-based; see General Information section for metric-based case size designators. <b>Note 2:</b> Values in shaded cells indicate thickness class.					

# Product selection chart

## NP0 – 50 V, Narrow Tolerance

Thickness classes and packing quantities							
Thickness class (mm)	8 mm tape width quantity per reel				Quantity per bulk case		
	180 mm / 7"	180 mm / 7"	330 mm / 13"	330 mm / 13"			
	Paper	Blister	Paper	Blister	0402	0603	0805
0.5 ±0.05	10 000	-	50 000	-	50 000	-	-
0.6 ±0.1	4 000	-	20 000	-	-	-	10 000
0.8 ±0.07	4 000	-	15 000	-	-	15 000	-
0.85 ±0.1	4 000	-	15 000	10 000	-	-	8 000
1.15 ±0.1	-	3 000	-	10 000	-	-	-
1.25 ±0.1	-	3 000	-	10 000	-	-	5 000

Ordering information								
Clear text code (preferred)								
0805CG102F9BB00 (example)								
0805	CG	102	F	9	B	B	0	0
Size code	Temp. char.	Cap. in pF	Tolerance	Voltage	Termination	Packing	Marking	Range identifier
0402 0603 0805 1206	CG = NP0	102 = 1000 pF The third digit signifies the multiplying factor: 8 = x 0.01 9 = x 0.1 0 = x 1 1 = x 10 2 = x 100	B = ±0.1 pF F = ±1%	9 = 50 V	B = NiSn	2 = 180 mm / 7" paper 3 = 330 mm / 13" paper B = 180 mm / 7" blister F = 330 mm / 13" blister P = bulk case	0 = no marking	0 = conv. ceramic

Ordering code 12NC	
<p>2 2 X X X X X X X X X X</p> <p>Carrier tape 22 = blister 38 = paper 54 = bulk</p> <p>Voltage 86 = 50 V</p> <p>Size 9 = 0402 7 = 0603 1 = 0805 3 = 1206</p>	<p>Capacitance value see selection chart</p> <p>Tolerance 4 = ±0.1 pF for C = 0.47 to 4.7 pF 8 = ±0.1 pF for C = 5.6 to 8.2 pF 8 = ±1% for C ≥10 pF</p> <p>Packing 1 = 180 mm / 7" reel 7 = 330 mm / 13" reel 4 = bulk case</p>

# Product selection chart

## X7R – 10 V, General Purpose

X7R - 10 V				
General purpose				
Capacitance (pF)	Last two digits of 12NC	0603	0805	1206
150 000	52			
220 000	54	0.8 ±0.07	0.6 ±0.1	
330 000	56		0.85 ±0.1	
470 000	58			
680 000	61		1.25 ±0.1	
1 000 000	63			0.85 ±0.1
1 500 000	65			
2 200 000	67			1.15 ±0.1
Tape width		8 mm		
<p><b>Note 1:</b> Case size designators are inch-based; see General Information section for metric-based case size designators.</p> <p><b>Note 2:</b> Values in shaded cells indicate thickness class.</p>				

# Product selection chart

## X7R – 10 V, General Purpose

Thickness classes and packing quantities						
Thickness class (mm)	8 mm tape width quantity per reel				Quantity per bulk case	
	180 mm / 7"	180 mm / 7"	330 mm / 13"	330 mm / 13"		
	Paper	Blister	Paper	Blister	0603	0805
0.6 ±0.1	4 000	-	20 000	-	-	10 000
0.8 ±0.07	4 000	-	15 000	-	15 000	-
0.85 ±0.1	4 000	-	15 000	-	-	8 000
1.15 ±0.1	-	3 000	-	10 000	-	-
1.25 ±0.1	-	3 000	-	10 000	-	5 000

### Ordering information

Clear text code (preferred)

06032R154K6BB0D (example)

0603	2R	154	K	6	B	B	0	D
Size code	Temp. char.	Cap. in pF	Tolerance	Voltage	Termination	Packing	Marking	Range identifier
0603 0805 1206	2R = X7R	154 = 150 000 pF The third digit signifies the multiplying factor: 4 = x 10 000 5 = x 100 000	K = ±10%	6 = 10 V	B = NiSn	2 = 180 mm / 7" paper 3 = 330 mm / 13" paper B = 180 mm / 7" blister F = 330 mm / 13" blister P = bulk case	0 = no marking	D = BME

### Ordering code 12NC

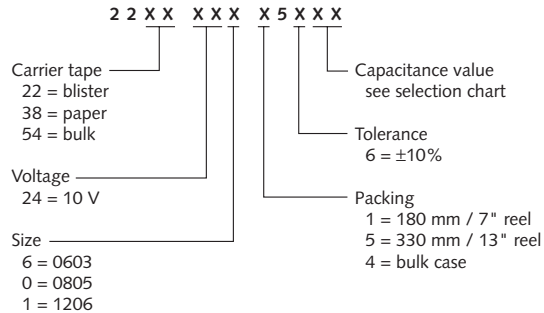



# Product selection chart

## X7R – 16 V to 100 V, General Purpose

X7R - 16 V and 25 V										
General purpose										
Capacitance (pF)	Last two digits of 12NC	16 V				25 V				
		0402	0603	0805	1206	0402	0603	0805	1206	1210
3 300	29									
4 700	32					0.5 ±0.05				
6 800	34									
10 000	36									
15 000	38	0.5 ±0.05					0.8 ±0.07	0.6 ±0.1		
22 000	41									
33 000	43									
47 000	45									
68 000	47		0.8 ±0.07	0.6 ±0.1				0.85 ±0.1		
100 000	49									
150 000	52			0.85 ±0.1					0.85 ±0.1	
220 000	54									
330 000	56			1.25 ±0.1	0.85 ±0.1				1.15 ±0.1	0.5 to 1.0
470 000	58									0.9 to 1.3
680 000	61					1.15 ±0.1				
1 000 000	63									
Tape width		8 mm				8 mm				

**Note 1:** Case size designators are inch-based; see General Information section for metric-based case size designators.  
**Note 2:** Values in shaded cells indicate thickness class.

X7R - 50 V and 100 V											
General purpose											
Capacitance (pF)	Last two digits of 12NC	50 V						100 V			
		0402	0603	0805	1206	1210	1812	0805	1206	1210	1812
100	09										
150	12										
220	14										
330	16										
470	18	0.5 ±0.05	0.6 ±0.07	0.6 ±0.1	0.85 ±0.1			0.6 ±0.1	0.85 ±0.1		
680	21										
1 000	23										
1 500	25										
2 200	27										
3 300	29										
4 700	32										
6 800	34										
10 000	36										
15 000	38										
22 000	41							0.85 ±0.1			
33 000	43										
47 000	45			0.85 ±0.1		0.5 to 1.0					
68 000	47			1.25 ±0.1					1.15 ±0.1	0.5 to 1.0	
100 000	49										
150 000	52				1.15 ±0.1					0.9 to 1.3	0.9 to 1.3
220 000	54					0.9 to 1.3	0.9 to 1.3				
330 000	56										
470 000	58										
680 000	61										
1 000 000	63						1.2 to 1.75				
Tape width		8 mm				12 mm		8 mm		12 mm	

**Note 1:** Case size designators are inch-based; see General Information section for metric-based case size designators.  
**Note 2:** Values in shaded cells indicate thickness class.

# Product selection chart

## X7R – 16 V to 100 V, General Purpose

Thickness classes and packing quantities								
Thickness class (mm)	8 mm tape width quantity per reel				12 mm tape width quantity per reel	Quantity per bulk case		
	180 mm / 7"	180 mm / 7"	330 mm / 13"	330 mm / 13"	180 mm / 7" blister			
	Paper	Blister	Paper	Blister	1812	0402	0603	0805
0.5 ±0.05	10 000	-	50 000	-	-	50 000	-	-
0.6 ±0.1	4 000	-	20 000	-	-	-	-	10 000
0.8 ±0.07	4 000	-	15 000	-	-	-	15 000	-
0.85 ±0.1	4 000	-	15 000	-	-	-	-	8 000
0.5 to 1.0	-	4 000	-	10 000	-	-	-	-
0.9 to 1.3	-	3 000	-	10 000	1 500	-	-	-
1.15 ±0.1	-	3 000	-	10 000	-	-	-	-
1.25 ±0.1	-	3 000	-	10 000	-	-	-	5 000
1.2 to 1.75	-	2 500	-	10 000	-	-	-	-

Ordering information								
Clear text code (preferred)								
18122R104K0BB0D (example)								
1812	2R	104	K	0	B	B	0	D
Size code	Temp. char.	Cap. in pF	Tolerance	Voltage	Termination	Packing	Marking	Range identifier
0402	2R = X7R	104 = 100 000 pF	J = ± 5%	7 = 16 V	B = NiSn	2 = 180 mm / 7" paper	0 = no marking	D = BME
0603		The third digit	K = ±10%	8 = 25 V		3 = 330 mm / 13" paper		
0805		signifies the		9 = 50 V		B = 180 mm / 7" blister		
1206		multiplying		0 = 100 V		F = 330 mm / 13" blister		
1210		factor:				P = bulk case		
1812								

Ordering code 12NC	
<p>2 2 X X X X X X</p>	<p>Carrier tape 22 = blister 38 = paper 54 = bulk</p> <p>Voltage 78 = 16 V 91 = 25 V 58 = 50 V 60 = 100 V</p> <p>Size 7 = 0402 6 = 0603 0 = 0805 1 = 1206 2 = 1210 4 = 1812</p>
	<p>Capacitance value see selection chart</p> <p>Tolerance 5 = ± 5% 6 = ±10%</p> <p>Packing 1 = 180 mm / 7" reel 5 = 330 mm / 13" reel 4 = bulk case</p>

# Product selection chart

## X7R – 200 V and 500 V, High Voltage

X7R - 200 V and 500 V								
High voltage								
Capacitance (pF)	Last two digits of 12NC	200 V				500 V		
		0805	1206	1210	1812	1206	1210	1812
220	14							
330	16							
470	18							
680	21							
1 000	23							
1 500	25	0.85 ±0.1	0.85 ±0.1			1.15 ±0.1		
2 200	27							
3 300	29							
4 700	32						0.9 to 1.3	
6 800	34	1.25 ±0.1					1.2 to 1.75	
10 000	36							0.9 to 1.3
15 000	38							
22 000	41		1.15 ±0.1					
33 000	43			0.9 to 1.3				
47 000	45							
68 000	47				0.9 to 1.3			
100 000	49							
Tape width		8 mm			12 mm	8 mm		12 mm

**Note 1:** Case size designators are inch-based; see General Information section for metric-based case size designators.  
**Note 2:** Values in shaded cells indicate thickness class.

# Product selection chart

## X7R – 200 V and 500 V, High Voltage

Thickness classes and packing quantities						
Thickness class (mm)	8 mm tape width quantity per reel				12 mm tape width quantity per reel	Quantity per bulk case
	180 mm / 7"	180 mm / 7"	330 mm / 13"	330 mm / 13"	180 mm / 7" blister	
	Paper	Blister	Paper	Blister	1812	0805
0.85 ±0.1	4 000		15 000		-	8 000
0.9 to 1.3	-	3 000	-	10 000	1 500	-
1.15 ±0.1	-	3 000	-	10 000	-	-
1.25 ±0.1	-	3 000	-	10 000	-	5 000
1.2 to 1.75	-	2 500	-	10 000	-	-

### Ordering information

Clear text code (preferred)

18122R104KBBB0D (example)

1812	2R	104	K	B	B	B	O	D
Size code	Temp. char.	Cap. in pF	Tolerance	Voltage	Termination	Packing	Marking	Range identifier
0805 1206 1210 1812	2R = X7R	104 = 100 000 pF The third digit signifies the multiplying factor: 1 = x 10 2 = x 100 3 = x 1 000 4 = x 10 000	J = ± 5 % K = ±10%	B = 200 V D = 500 V	B = NiSn	2 = 180 mm / 7" paper 3 = 330 mm / 13" paper B = 180 mm / 7" blister F = 330 mm / 13" blister P = bulk case	0 = no marking	D = BME

### Ordering code 12NC

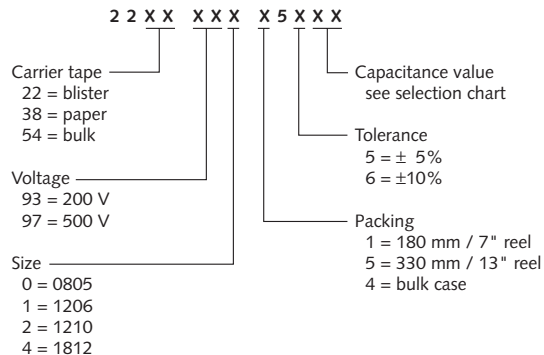

# Product selection chart

## X7R – 1 kV and 2 kV, High Voltage

X7R - 1 kV and 2kV						
High voltage						
Capacitance (pF)	Last two digits of 12NC	1 kV			2 kV	
		1206	1808	1812	1808	1812
470	18					
680	21					
1 000	23					
1 500	25	0.9 to 1.3	1.2 to 1.75	1.2 to 1.75	1.2 to 1.75	1.2 to 1.75
2 200	27					
3 300	29					
4 700	32					
6 800	34					
10 000	36					
Tape width		8 mm	12 mm		12 mm	

**Note 1:** Case size designators are inch-based; see General Information section for metric-based case size designators.

**Note 2:** Values in shaded cells indicate thickness class.

Thickness classes and packing quantities				
Thickness class (mm)	8 mm tape width quantity per reel		12 mm tape width quantity per reel	
	180 mm / 7" blister	330 mm / 13" blister	180 mm / 7" blister	
	1206	1206	1808	1812
0.9 to 1.3	3 000	10 000	-	-
1.2 to 1.75	-	-	1 000	1 000

Ordering information								
Clear text code (preferred)								
12062R102KEB00 (example)								
1206	2R	102	K	E	B	B	0	0
Size code	Temp. char.	Cap. in pF	Tolerance	Voltage	Termination	Packing	Marking	Range identifier
1206	2R = X7R	102 = 1000 pF	K = ±10%	E = 1 kV F = 2 kV	B = NiSn	B = 180 mm / 7" blister F = 330 mm / 13" blister	0 = no marking	0 = conv. ceramic
1808		The third digit signifies the multiplying factor:						
1812		1 = x 10 2 = x 100 3 = x 1000						

Ordering code 12NC									
		2 2 X X		X X X		X 6 X X X			
Carrier tape	50 = blister	Voltage	00 = 1 kV 02 = 2 kV	Size	1 = 1206 3 = 1210 4 = 1812	Capacitance value	see selection chart	Tolerance	6 = ±10%
						Packing	1 = 180 mm / 7" reel 5 = 330 mm / 13" reel		

# Product selection chart

## X7R – 16 V to 50 V, Low Inductance

X7R - 16 V to 50 V				
Low inductance				
Capacitance (pF)	Last two digits of 12NC	16 V	25 V	50 V
10 000	36	0508	0508	0612
15 000	38			
22 000	41			
33 000	43		0.85 ±0.1	0.85 ±0.1
47 000	45			
68 000	47			
100 000	49			
150 000	52	0.85 ±0.1		
220 000	54			
Tape width		8 mm		

**Note 1:** Case size designators are inch-based; see General Information section for metric-based case size designators.

**Note 2:** Values in shaded cells indicate thickness class.

Thickness classes and packing quantities		
Thickness class (mm)	8 mm tape width quantity per reel	
	180 mm / 7" Paper	330 mm / 13" Paper
0.85 ±0.1	4 000	15 000

Ordering information								
Clear text code (preferred)								
06122R103K9BB0L (example)								
0612	2R	103	K	9	B	B	0	L
Size code	Temp. char.	Cap. in pF	Tolerance	Voltage	Termination	Packing	Marking	Range identifier
0508	2R = X7R	103 = 10 000 pF	K = ±10%	7 = 16 V	B = NiSn	2 = 180 mm / 7" paper	0 = no marking	L = low inductance
0612		The third digit signifies the multiplying factor 3 = x 1 000 4 = x 10 000		8 = 25 V 9 = 50 V		3 = 330 mm / 13" paper		

Ordering code 12NC	
<p>2 2 X X X X X X X</p> <p>Carrier tape 55 = paper</p> <p>Voltage 08 = 16 V 07 = 25 V 06 = 50 V</p> <p>Size 1 = 0508 0 = 0612</p>	<p>X 6 X X X</p> <p>Capacitance value see selection chart</p> <p>Tolerance 6 = ±10%</p> <p>Packing 1 = 180 mm / 7" reel 5 = 330 mm / 13" reel</p>

# Product selection chart

## Y5V – 10 V, General Purpose

Y5V - 10 V				
General purpose				
Capacitance ( $\mu$ F)	Last two digits of 12NC	0603	0805	1206
1.0	63	0.8 $\pm$ 0.07		
2.2	67		1.25 $\pm$ 0.1	
4.7	72			
10	76			1.6 $\pm$ 0.15
Tape width		8 mm		
<b>Note 1:</b> Case size designators are inch-based; see General Information section for metric-based case size designators. <b>Note 2:</b> Values in shaded cells indicate thickness class.				

# Product selection chart

## Y5V – 10 V, General Purpose

Thickness classes and packing quantities						
Thickness class (mm)	8 mm tape width quantity per reel				Quantity per bulk case	
	180 mm / 7"	180 mm / 7"	330 mm / 13"	330 mm / 13"		
	Paper	Blister	Paper	Blister	0603	0805
0.8 ±0.07	4 000	-	15 000	-	15 000	-
1.25 ±0.1	-	3 000	-	10 000	-	5 000
1.6 ±0.15	-	2 500	-	7 000	-	-

### Ordering information

Clear text code (preferred)

12062F105Z6BB0D (example)

1206	2F	105	Z	6	B	B	0	D
Size code	Temp. char.	Cap. in pF	Tolerance	Voltage	Termination	Packing	Marking	Range identifier
0603 0805 1206	2F = Y5V	105 = 1 000 000 pF The third digit signifies the multiplying factor: 5 = x 100 000 6 = x 1 000 000	Z = -20 to +80%	6 = 10 V	B = NiSn	2 = 180 mm / 7" paper 3 = 330 mm / 13" paper B = 180 mm / 7" blister F = 330 mm / 13" blister P = bulk case	0 = no marking	D = BME

### Ordering code 12NC

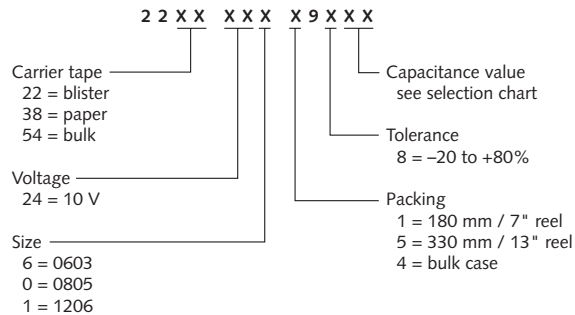



# Product selection chart

## Y5V – 16 V to 50 V, General Purpose

Y5V - 16 V and 25 V								
General purpose								
Capacitance (pF)	Last two digits of 12NC	16 V				25 V		
		0402	0603	0805	1206	0603	0805	1206
10 000	36							
22 000	41	0.5 ±0.05				0.8 ±0.07		
47 000	45							
100 000	49						0.6 ±0.1	0.6 ±0.1
220 000	54		0.8 ±0.07				0.85 ±0.1	
470 000	58			0.85 ±0.1			1.25 ±0.1	0.85 ±0.1
1 000 000	63			1.25 ±0.1	0.85 ±0.1			1.15 ±0.1
2 200 000	67				1.15 ±0.1			
4 700 000	72							
Tape width		8 mm				8 mm		

**Note 1:** Case size designators are inch-based; see General Information section for metric-based case size designators.  
**Note 2:** Values in shaded cells indicate thickness class.

Y5V - 50 V				
General purpose				
Capacitance (pF)	Last two digits of 12NC	50 V		
		0603	0805	1206
10 000	05			
22 000	07	0.8 ±0.07	0.6 ±0.1	
47 000	09			
100 000	12			0.6 ±0.1
220 000	14		0.85 ±0.1	
470 000	16			0.85 ±0.1
1 000 000	18			1.15 ±0.1
Tape width		8 mm		

**Note 1:** Case size designators are inch-based; see General Information section for metric-based case size designators.  
**Note 2:** Values in shaded cells indicate thickness class.

# Product selection chart

## Y5V – 16V to 50 V, General Purpose

Thickness classes and packing quantities							
Thickness class (mm)	8 mm tape width quantity per reel				Quantity per bulk case		
	180 mm / 7"	180 mm / 7"	330 mm / 13"	330 mm / 13"			
	Paper	Blister	Paper	Blister	0402	0603	0805
0.5 ±0.05	10 000	-	50 000	-	50 000	-	-
0.6 ±0.1	4 000	-	20 000	-	-	-	10 000
0.8 ±0.07	4 000	-	15 000	-	-	15 000	-
0.85 ±0.1	4 000	-	15 000	-	-	-	8 000
1.15 ±0.1	-	3 000	-	10 000	-	-	-
1.25 ±0.1	-	3 000	-	10 000	-	-	5 000

Ordering information								
Clear text code (preferred)								
12062F684M8BB0D (example)								
1206	2F	684	M	8	B	B	0	D
Size code	Temp. char.	Cap. in pF	Tolerance	Voltage	Termination	Packing	Marking	Range identifier
0402 0603 0805 1206	2F = Y5V	684 = 680 000 pF The third digit signifies the multiplying factor: 2 = x 100 3 = x 1 000 4 = x 10 000 5 = x 100 000	M = ±20% Z = -20 to +80%	7 = 16 V 8 = 25 V 9 = 50 V	B = NiSn	2 = 180 mm / 7" paper 3 = 330 mm / 13" paper B = 180 mm / 7" blister F = 330 mm / 13" blister P = bulk case	0 = no marking	D = BME

Ordering code 12NC	
<p>2 2 X X X X X X</p> <p>Carrier tape 22 = blister 38 = paper 54 = bulk</p> <p>Voltage 78 = 16 V 91 = 25 V 58 = 50 V</p> <p>Size 7 = 0402 6 = 0603 0 = 0805 1 = 1206</p>	<p>X 9 X X X</p> <p>Capacitance value see selection chart</p> <p>Tolerance 7 = ±20% 8 = -20 to +80%</p> <p>Packing 1 = 180 mm / 7" reel 5 = 330 mm / 13" reel 4 = bulk case</p>

# Product selection chart

## Z5U – 25 V and 50 V, General Purpose

Z5U - 25 V and 50 V						
General purpose						
Capacitance (pF)	Last two digits of 12NC	25 V		50 V		
		0603	1206	0805	1206	1210
10 000	36					
22 000	41					
47 000	45	0.8 ±0.07		0.6 ±0.1	0.6 ±0.1	
100 000	49					
220 000	54			1.25 ±0.1		0.5 to 1.0
470 000	58		1.15 ±0.1		1.15 ±0.1	
1 000 000	63					0.9 to 1.3
Tape width		8 mm			8 mm	

**Note 1:** Case size designators are inch-based; see General Information section for metric-based case size designators.  
**Note 2:** Values in shaded cells indicate thickness class.

# Product selection chart

## Z5U – 25 V and 50 V, General Purpose

Thickness classes and packing quantities						
Thickness class (mm)	8 mm tape width quantity per reel				Quantity per bulk case	
	180 mm / 7"	180 mm / 7"	330 mm / 13"	330 mm / 13"		
	Paper	Blister	Paper	Blister	0603	0805
0.6 ±0.1	4 000	-	20 000	-	-	10 000
0.8 ±0.07	4 000	-	15 000	-	15 000	-
0.5 to 1.0	-	4 000	-	10 000	-	-
0.9 to 1.3	-	3 000	-	10 000	-	-
1.15 ±0.1	-	3 000	-	10 000	-	-
1.25 ±0.1	-	3 000	-	10 000	-	5 000

Ordering information								
Clear text code (preferred)								
06032E104Z8B2D (example)								
0603	2E	104	Z	8	B	2	0	D
Size code	Temp. char.	Cap. in pF	Tolerance	Voltage	Termination	Packing	Marking	Range identifier
0603	2E = Z5U	104 = 100 000 pF	M = ±20%	8 = 25 V	B = NiSn	2 = 180 mm / 7" paper	0 = no marking	D = BME
0805		The third digit	Z =	9 = 50 V		3 = 330 mm / 13" paper		
1206		signifies the	-20 to +80%			B = 180 mm / 7" blister		
1210		multiplying				F = 330 mm / 13" blister		
		factor:				P = bulk case		
		3 = x 1 000						
		4 = x 10 000						
		5 = x 100 000						

Ordering code 12NC	
<p>2 2 X X 6 2 X X X X X</p> <p>Carrier tape ———</p> <p>22 = blister</p> <p>38 = paper</p> <p>54 = bulk</p> <p>Size ———</p> <p>5 = 0603 (25 V)</p> <p>0 = 0805 (50 V)</p> <p>1 = 1206 (50 V)</p> <p>7 = 1206 (25 V)</p> <p>2 = 1210 (50 V)</p>	<p>Capacitance value see selection chart</p> <p>Tolerance</p> <p>7 = ±20%</p> <p>8 = -20 to +80%</p> <p>Packing</p> <p>1 = 180 mm / 7" reel</p> <p>5 = 330 mm / 13" reel</p> <p>4 = bulk case</p>



Phycomp's innovative range  
of C and R arrays help to reduce  
board space whilst simplifying  
circuit layout and assembly

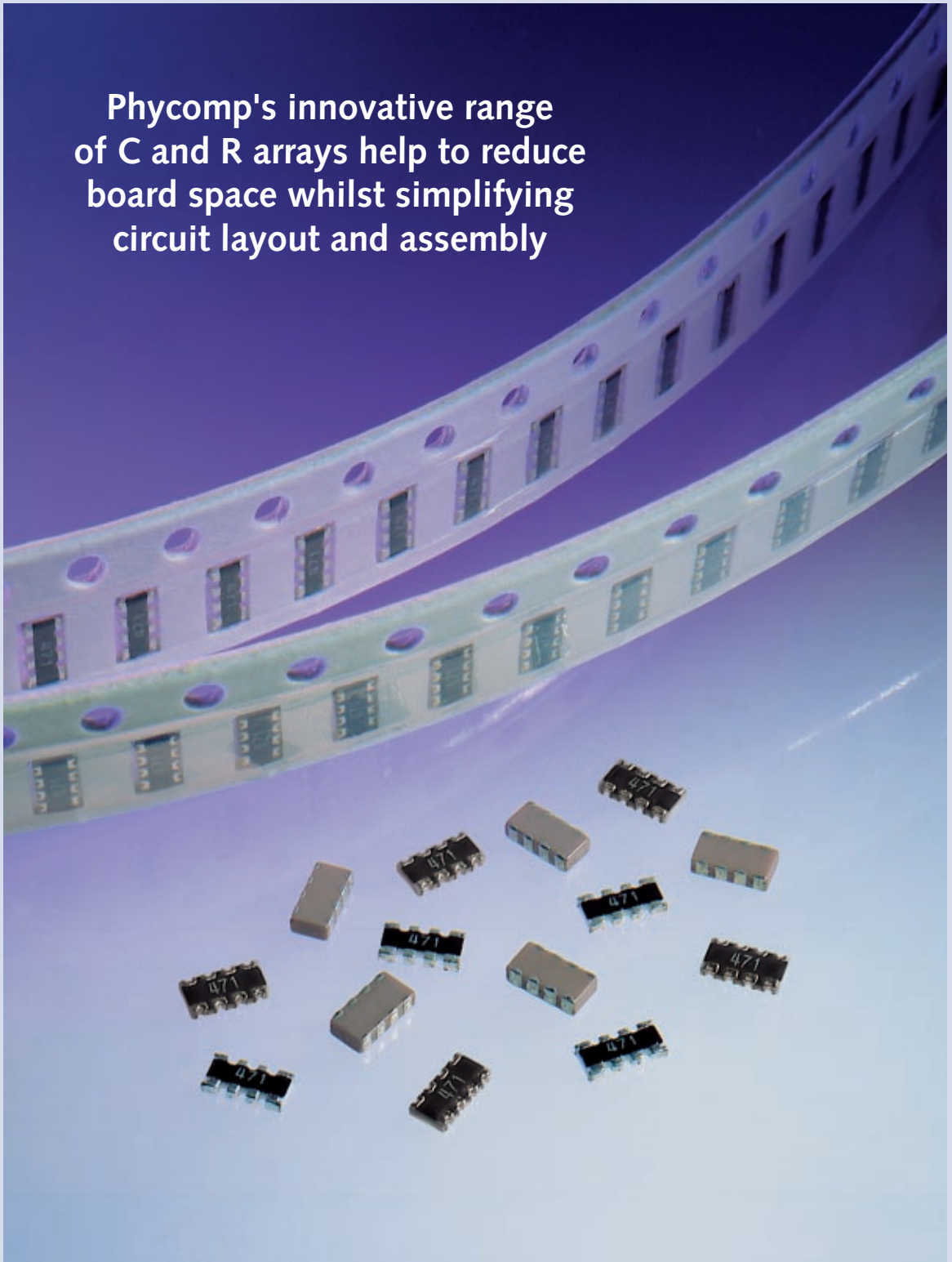

# Product selection chart

## NP0 – 50 V, 4-C Arrays

NP0 - 50 V			
4-C arrays			
Capacitance (pF)	Last two digits of 12NC	0508 (4 x 0402)	0612 (4 x 0603)
10	23		
12	24		
15	25		
18	26		
22	27		
27	28		
33	29		
39	31		
47	32	0.6 ±0.1	0.8 ±0.1
56	33		
68	34		
82	35		
100	36		
120	37		
150	38		
180	39		
220	41		
270	42		
330	43		
390	44		
470	45		
560	46		
680	47		
820	48		
1 000	49		
Tape width		8 mm	

**Note 1:** Case size designators are inch-based; see General Information section for metric-based case size designators.  
**Note 2:** Values in shaded cells indicate thickness class.

# Product selection chart

## NPO – 50 V, 4-C Arrays

Thickness classes and packing quantities	
Thickness class (mm)	8 mm tape width quantity per reel
	180 mm / 7"
	Paper
0.6 ±0.1	4 000
0.8 ±0.1	4 000

Ordering information								
Clear text code (preferred)								
0508CG221J9B100 (example)								
0508	CG	221	J	9	B	1	0	0
Size code	Temp. char.	Cap. in pF	Tolerance	Voltage	Termination	Packing	Marking	Range identifier
0508 (4 x 0402) 0612 (4 x 0603)	CG = NPO	221 = 220 pF The third digit signifies the multiplying factor: 0 = x 1 1 = x 10 2 = x 100	J = ± 5% K = ±10%	9 = 50 V	B = NiSn	2 = 180 mm / 7" paper	0 = no marking	0 = conv. ceramic

Ordering code 12NC	
<p>2 2 X X X X X X</p> <p>Carrier tape ——— 55 = paper</p> <p>Voltage ——— 14 = 50 V</p> <p>Size ——— 7 = 0508 (4 x 0402) 6 = 0612 (4 x 0603)</p>	<p>X 1 X X X</p> <p>Capacitance value see selection chart</p> <p>Tolerance 5 = ± 5% 6 = ±10%</p> <p>Packing 1 = 180 mm / 7" reel</p>



# Product selection chart

## X7R – 16 V, 4-C Arrays

X7R - 16 V			
		4-C arrays	
Capacitance (pF)	Last two digits of 12NC	16 V	
		0508 (4 x 0402)	0612 (4 x 0603)
10 000	36		
15 000	38		
22 000	41	0.6 ±0.1	0.8 ±0.1
33 000	43		
47 000	45		
68 000	47		
100 000	49		
Tape width		8 mm	

**Note 1:** Case size designators are inch-based; see General Information section for metric-based case size designators.  
**Note 2:** Values in shaded cells indicate thickness class.

# Product selection chart

## X7R – 16 V, 4-C Arrays

Thickness classes and packing quantities	
Thickness class (mm)	8 mm tape width quantity per reel
	180 mm / 7"
	Paper
0.6 ±0.1	4 000
0.8 ±0.1	4 000

Ordering information								
Clear text code (preferred)								
06122R103K7B10D (example)								
0612	2R	103	K	7	B	1	0	D
Size code	Temp. char.	Cap. in pF	Tolerance	Voltage	Termination	Packing	Marking	Range identifier
0508 (4 x 0402) 0612 (4 x 0603)	2R = X7R	103 = 10 000 pF The third digit signifies the multiplying factor: 2 = x 100 3 = x 1 000 4 = x 10 000	K = ±10%	7 = 16 V	B = NiSn	2 = 180 mm / 7" paper	0 = no marking	D = BME

Ordering code 12NC	
<p>2 2 X X X X X X</p> <p>Carrier tape 55 = paper</p> <p>Voltage 10 = 16 V</p> <p>Size 7 = 0508 (4 x 0402) 6 = 0612 (4 x 0603)</p>	<p>X 5 X X X</p> <p>Capacitance value see selection chart</p> <p>Tolerance 6 = ±10%</p> <p>Packing 1 = 180 mm / 7" reel</p>

# Product selection chart

## X7R – 25 V and 50 V, 4-C Arrays

X7R - 25 V and 50 V				
4-C arrays				
Capacitance (pF)	Last two digits of 12NC	25 V	50 V	50 V
		0612 (4 x 0603)	0508 (4 x 0402)	0612 (4 x 0603)
220	14			
330	16			
470	18			
680	21			
1 000	23		0.6 ±0.1	0.8 ±0.1
1 500	25			
2 200	27			
3 300	29			
4 700	32			
6 800	34			
10 000	36			
15 000	38			
22 000	41	0.8 ±0.1		
33 000	43			
47 000	45			
68 000	47	1.2 ±0.1		
Tape width		8 mm		

**Note 1:** Case size designators are inch-based; see General Information section for metric-based case size designators.  
**Note 2:** Values in shaded cells indicate thickness class.

# Product selection chart

## X7R – 25 V and 50 V, 4-C Arrays

Thickness classes and packing quantities		
Thickness class (mm)	8 mm tape width quantity per reel	
	180 mm / 7"	180 mm / 7"
	Paper	Blister
0.6 ±0.1	4 000	-
0.8 ±0.1	4 000	-
1.2 ±0.1	-	3 000

### Ordering information

Clear text code (preferred)

06122R104K7B200 (example)

0612	2R	104	K	7	B	2	0	0
Size code	Temp. char.	Cap. in pF	Tolerance	Voltage	Termination	Packing	Marking	Range identifier
0508 (4 x 0402)	2R = X7R	104 = 100 000 pF The third digit signifies the multiplying factor: 1 = x 10 2 = x 100 3 = x 1 000 4 = x 10 000	K = ±10% M = ±20%	8 = 25 V 9 = 50 V	B = NiSn	2 = 180 mm / 7" paper B = 180 mm / 7" blister	0 = no marking	0 = conv. ceramic
0612 (4 x 0603)								

### Ordering code 12NC

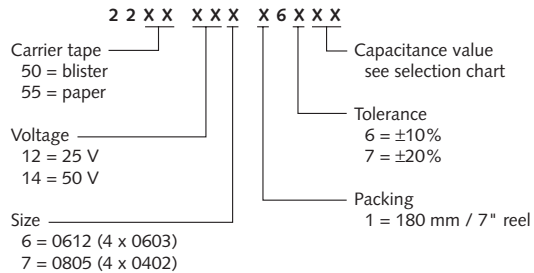

# Product selection chart

## Y5V – 25 V, 4-C Arrays

Y5V - 25 V		
4-C arrays		
Capacitance (pF)	Last two digits of 12NC	0612 (4 x 0603)
10 000	36	0.6 ±0.1
22 000	41	
47 000	45	
100 000	49	
Tape width		8 mm

**Note 1:** Case size designators are inch-based; see General Information section for metric-based case size designators.

**Note 2:** Values in shaded cells indicate thickness class.

### Thickness classes and packing quantities

Thickness class (mm)	8 mm tape width quantity per reel
0.6 ±0.1	180 mm / 7"
	Paper
	4 000

### Ordering information

Clear text code (preferred)

06122F104Z7B20D (example)

0612	2F	104	Z	7	B	2	0	D
Size code	Temp. char.	Cap. in pF	Tolerance	Voltage	Termination	Packing	Marking	Range identifier
0612 (4 x 0603)	2F = Y5V	104 = 100 000 pF The third digit signifies the multiplying factor: 4 = 10 000	Z = -20 to +80%	8 = 25 V	B = NiSn	2 = 180 mm / 7" paper	0 = no marking	D = BME

### Ordering code 12NC

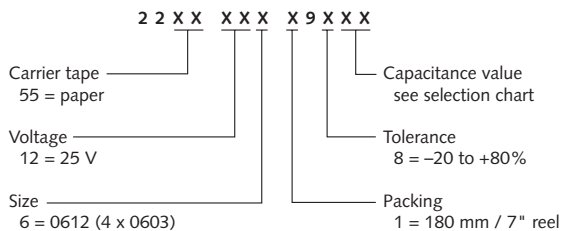

## Phycomp's new feedthrough capacitors and arrays are ideal for suppression of HF noise in digital systems

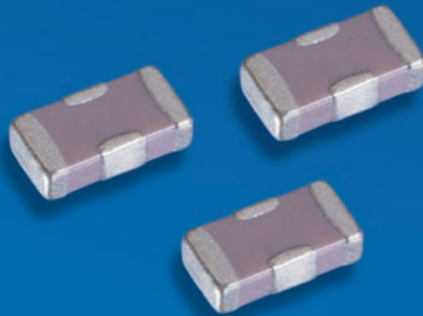
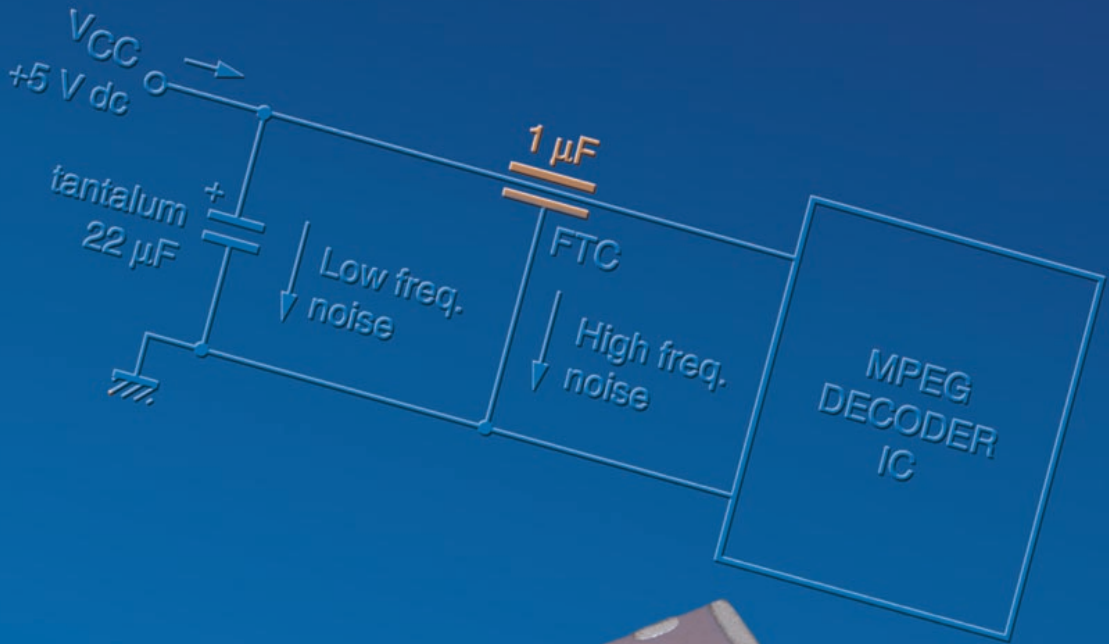

# Product selection chart

## NPO – 50 V, Feedthrough Capacitors

NPO - 50 V								
Feedthrough capacitors								
Capacitance (pF)	Last two digits of 12NC						1206	
47	32							
68	34							
100	36							
150	38							
220	41						0.8 ±0.1	
330	43							
470	45							
680	47							
1 000	49							
Tape width							8 mm	
<b>Note 1:</b> Case size designators are inch-based; see General Information section for metric-based case size designators. <b>Note 2:</b> Values in shaded cells indicate thickness class.								
Thickness classes and packing quantities								
Thickness class (mm)	8 mm tape width							
	quantity per reel							
	180 mm / 7"							
0.8 ±0.1	Paper							4 000
Ordering information								
Clear text code (preferred)								
1206CG102J9B20F (example)								
1206	CG	102	J	9	B	2	0	F
Size code	Temp. char.	Cap. in pF	Tolerance	Voltage	Termination	Packing	Marking	Range identifier
1206	CG = NPO	102 = 1000 pF The third digit signifies the multiplying factor: 0 = x 1 1 = x 10 2 = x 100	J = ± 5% K = ±10%	9 = 50 V	B = NiSn	2 = 180 mm / 7" paper	0 = no marking	F = feedthrough
Ordering code 12NC								
<div style="text-align: center;"> <b>2 2 X X X X X X</b> </div> <div style="display: flex; justify-content: space-between; margin-top: 10px;"> <div style="width: 45%;"> <p>Carrier tape 55 = paper</p> <p>Voltage 23 = 50 V</p> <p>Size 1 = 1206</p> </div> <div style="width: 45%;"> <p>Capacitance value see selection chart</p> <p>Tolerance 5 = ± 5% 6 = ±10%</p> <p>Packing 1 = 180 mm / 7" reel</p> </div> </div>								

# Product selection chart

## X7R – 16 V to 50 V, Feedthrough Capacitors

X7R - 16 V to 50 V				
Feedthrough capacitors				
Capacitance (pF)	Last two digits of 12NC	16 V	25 V	50 V
		1206	1206	1206
4 700	32			
6 800	34			0.8 ±0.1
10 000	36			
15 000	38			
22 000	41			
33 000	43		0.8 ±0.1	
47 000	45			
68 000	47			
100 000	49			
680 000	61	1.2 ±0.15		
1 000 000	63			
Tape width		8 mm		
<b>Note 1:</b> Case size designators are inch-based; see General Information section for metric-based case size designators.				
<b>Note 2:</b> Values in shaded cells indicate thickness class.				

Thickness classes and packing quantities		
Thickness class (mm)	8 mm tape width quantity per reel	8 mm tape width quantity per reel
	180 mm / 7" Paper	180 mm / 7" Blister
0.8 ±0.1	4 000	-
1.2 ±0.1	-	3 000

Ordering information								
Clear text code (preferred)								
12062R104K9BBOF (example)								
1206	2R	104	K	9	B	B	0	F
Size code	Temp. char.	Cap. in pF	Tolerance	Voltage	Termination	Packing	Marking	Range identifier
1206	2R = X7R	104 = 100 000 pF The third digit signifies the multiplying factor: 2 = x 100 3 = x 1 000 4 = x 10 000 5 = x 100 000	K = ±10% M = ±20%	7 = 16 V 8 = 25 V 9 = 50 V	B = NiSn	2 = 180 mm / 7" paper B = 180 mm / 7" blister	0 = no marking	F = feedthrough

Ordering code 12NC	
<p>2 2 X X X X X X</p> <p>Carrier tape 50 = blister 55 = paper</p> <p>Voltage 53 = 16 V 52 = 25 V 23 = 50 V</p> <p>Size 1 = 1206</p>	<p>X 5 X X X</p> <p>Capacitance value see selection chart</p> <p>Tolerance 6 = ±10% 7 = ±20%</p> <p>Packing 1 = 180 mm / 7" reel</p>



# Product selection chart

## NPO – 50 V, Feedthrough 4-C Arrays

NPO - 50 V								
Feedthrough 4-C arrays								
Capacitance (pF)	Last two digits of 12NC					0612 (4 x 0603)		
47	32							
56	33							
68	34							
82	35							
100	36							
120	37					0.8 ±0.1		
150	38							
180	39							
220	41							
270	42							
330	43							
390	44							
470	45							
Tape width						8 mm		
<b>Note 1:</b> Case size designators are inch-based; see General Information section for metric-based case size designators. <b>Note 2:</b> Values in shaded cells indicate thickness class.								
Thickness classes and packing quantities								
Thickness class (mm)	8 mm tape width							
	quantity per reel							
	180 mm / 7"							
0.8 ±0.1	Paper							
	4 000							
Ordering information								
Clear text code (preferred)								
0612CG101J9B20F (example)								
0612	CG	101	J	9	B	2	0	F
Size code	Temp. char.	Cap. in pF	Tolerance	Voltage	Termination	Packing	Marking	Range identifier
0612 (4 x 0603)	CG = NPO	101 = 100 pF The third digit signifies the multiplying factor: 0 = x 1 1 = x 10	J = ± 5% K = ±10%	9 = 50 V	B = NiSn	2 = 180 mm / 7" paper	0 = no marking	F = feedthrough
Ordering code 12NC								
<div style="text-align: center;"> <b>2 2 X X X X X X</b> </div> <div style="display: flex; justify-content: space-between;"> <div style="width: 45%;"> <p>Carrier tape ————</p> <p>55 = paper</p> <p>Voltage ————</p> <p>26 = 50 V</p> <p>Size ————</p> <p>6 = 0612 (4 x 0603)</p> </div> <div style="width: 45%;"> <p>Capacitance value ————</p> <p>see selection chart</p> <p>Tolerance ————</p> <p>5 = ± 5% 6 = ±10%</p> <p>Packing ————</p> <p>1 = 180 mm / 7" reel</p> </div> </div>								

# Product selection chart

## X7R – 50 V, Feedthrough 4-C Arrays

X7R - 50 V		
Feedthrough 4-C arrays		
Capacitance (pF)	Last two digits of 12NC	0612 (4 x 0603)
1 000	23	
1 500	25	
2 200	27	
3 300	29	0.8 ±0.1
4 700	32	
6 800	34	
10 000	36	
Tape width		8 mm

**Note 1:** Case size designators are inch-based; see General Information section for metric-based case size designators.  
**Note 2:** Values in shaded cells indicate thickness class.

Thickness classes and packing quantities	
Thickness class (mm)	8 mm tape width quantity per reel
	180 mm / 7"
	Paper
0.8 ±0.1	4 000

Ordering information								
Clear text code (preferred)								
06122R102K9B20G (example)								
0612	2R	102	K	9	B	2	0	G
Size code	Temp. char.	Cap. in pF	Tolerance	Voltage	Termination	Packing	Marking	Range identifier
0612 (4 x 0603)	2R = X7R	102 = 1 000 pF The third digit signifies the multiplying factor: 2 = x 100 3 = x 1 000	K = ±10% M = ±20%	9 = 50 V	B = NiSn	2 = 180 mm / 7" paper	0 = no marking	G = FTC BME

Ordering code 12NC	
2 2 X X X X X X X X Carrier tape 55 = paper  Voltage 26 = 50 V  Size 6 = 0612 (4 x 0603)	X 5 X X X X Capacitance value see selection chart  Tolerance 6 = ±10% 7 = ±20%  Packing 1 = 180 mm / 7" reel

# Product selection chart

## NPO – 50 V, Ultra Small MLCCs

NPO - 50 V		
Ultra small MLCCs		
Capacitance (pF)	Last three digits of 12NC	
1.0	108	0201
1.2	128	
1.5	158	
1.8	188	
2.2	228	
2.7	278	
3.3	338	
3.9	398	0.3 ±0.03
4.7	478	
5.6	568	
6.8	688	
8.2	828	
10	109	
12	129	
15	159	
18	189	
22	229	
Tape width		8 mm

**Note 1:** Case size designators are inch-based; see General Information section for metric-based case size designators.  
**Note 2:** Values in shaded cells indicate thickness class.

# Product selection chart

## NPO – 50 V, Ultra Small MLCCs

Thickness classes and packing quantities			
Thickness class (mm)	8 mm tape width quantity per reel		Quantity per bulk case
	180 mm / 7"	330 mm / 13"	
	Paper	Paper	0201
0.3 ±0.03	15 000	t.b.d.	t.b.d.

### Ordering information

Clear text code (preferred)

0201CG479J9B200 (example)								
0201	CG	479	J	9	B	2	0	0
Size code	Temp. char.	Cap. in pF	Tolerance	Voltage	Termination	Packing	Marking	Range identifier
0201	CG = NPO	479 = 4.7 pF The third digit signifies the multiplying factor: 9 = x 0.1 0 = x 1	C = ±0.25 pF D = ±0.5 pF G = ±2% J = ±5%	9 = 50 V	B = NiSn	2 = 180 mm / 7" paper 3 = 330 mm / 7" paper P = bulk case	0 = no marking	0 = conv. ceramic

### Ordering code 12NC

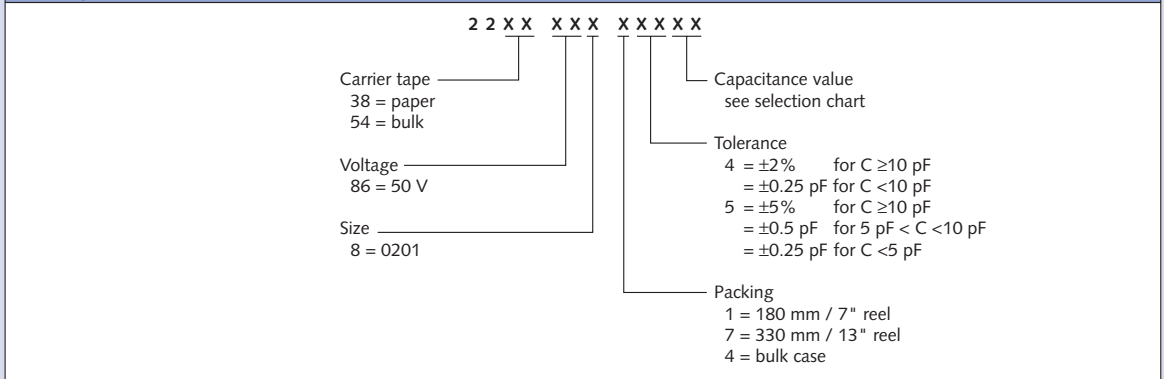

# Product selection chart

## X7R – 16 V to 50 V, Ultra Small MLCCs

X7R - 16 V to 50 V				
Ultra small MLCCs				
Capacitance (pF)	Last two digits of 12NC	16 V	25 V	50 V
47	05	0201	0201	0201
68	07			
100	09			
150	12			0.3 ±0.03
220	14			
330	16			
470	18			
680	21			
1 000	23		0.3 ±0.03	
1 500	25			
2 200	27	0.3 ±0.03		
3 300	29			
Tape width		8 mm		
<b>Note 1:</b> Case size designators are inch-based; see General Information section for metric-based case size designators. <b>Note 2:</b> Values in shaded cells indicate thickness class.				

# Product selection chart

## X7R – 16 V to 50 V, Ultra Small MLCCs

Thickness classes and packing quantities			
Thickness class (mm)	8 mm tape width quantity per reel		Quantity per bulk case
	180 mm / 7"	330 mm / 13"	
	Paper	Paper	
0.3 ±0.03	15 000	t.b.d.	0201

### Ordering information

Clear text code (preferred)

02012R102J7B200 (example)

0201	2R	102	J	7	B	2	0	0
Size code	Temp. char.	Cap. in pF	Tolerance	Voltage	Termination	Packing	Marking	Range identifier
0201	2R = X7R	102 = 1 000 pF The third digit signifies the multiplying factor: 0 = x 1 1 = x 10 3 = x 100	J = ± 5% K = ±10%	7 = 16 V 8 = 25 V 9 = 50 V	B = NiSn	2 = 180 mm / 7" paper	0 = no marking	0 = conv. ceramic

### Ordering code 12NC

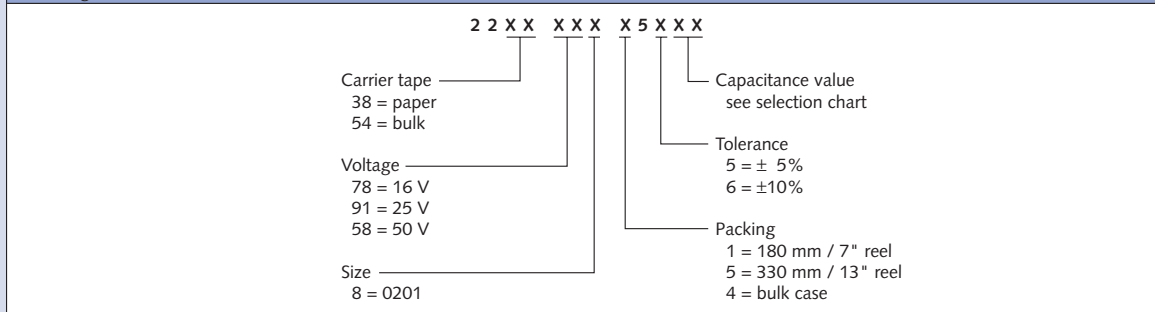

## MLCC Sample Kits

### Circuit designers take note!

For its popular ceramic multilayer capacitors series, Phycomp Components has a completely new range of Sample Kits available to support customer design-in activities.

The range comprises four kits for our 0402, 0603, 0805 and 1206 capacitors. Each kit contains representative samples in NP0, X7R and Y5V. Also available is a special kit containing all sizes, all dielectrics and special products but limited values (only decade E1 capacitance values).

0402			
NPO 50 V		X7R 50 V	
Capacitance (pF)	Tolerance	Capacitance (pF)	Tolerance
0.47	±0.25 pF	100	± 10%
0.68	±0.25 pF	150	± 10%
1	±0.25 pF	220	± 10%
1.5	±0.25 pF	330	± 10%
2.2	±0.25 pF	470	± 10%
3.3	±0.25 pF	680	± 10%
4.7	±0.25 pF	1 000	± 10%
6.8	±0.50 pF	1 500	± 10%
10	± 5%	2 200	± 10%
15	± 5%	3 300	± 10%
22	± 5%	<b>X7R 25 V</b>	
		Capacitance (pF)	Tolerance
33	± 5%	4 700	± 10%
47	± 5%	<b>X7R 16 V</b>	
		Capacitance (pF)	Tolerance
68	± 5%	6 800	± 10%
100	± 5%	10 000	± 10%
150	± 5%	15 000	± 10%
220	± 5%	22 000	± 10%
<b>Y5V 16 V</b>			
Capacitance (pF)	Tolerance		
10 000	± 20%		
22 000	± 20%		
47 000	± 20%		
100 000	± 20%		

95 pieces per value

Ordering code:4322 044 09911



# MLCC Sample Kits

0603

0603					
NPO 50 V		NPO 25 V		X7R 16 V	
Capacitance (pF)	Tolerance	Capacitance (pF)	Tolerance	Capacitance (pF)	Tolerance
0.47	±0.25pF	1 000	± 5%	33 000	± 10%
0.68	±0.25pF	1 500	± 5%	47 000	± 10%
1	±0.25pF	<b>X7R 50 V</b>		68 000	± 10%
1.5	±0.25pF	Capacitance (pF)	Tolerance	100 000	± 10%
2.2	±0.25pF	100	± 10%	<b>Y5V 50 V</b>	
3.3	±0.25pF	150	± 10%	Capacitance (pF)	Tolerance
4.7	±0.25pF	220	± 10%	10 000	± 20%
6.8	±0.50pF	330	± 10%	22 000	± 20%
10	± 5%	470	± 10%	47 000	± 20%
15	± 5%	680	± 10%	100 000	± 20%
22	± 5%	1 000	± 10%	<b>Y5V 16 V</b>	
33	± 5%	1 500	± 10%	Capacitance (pF)	Tolerance
47	± 5%	2 200	± 10%	220 000	± 20%
68	± 5%	3 300	± 10%	470 000	± 20%
100	± 5%	4 700	± 10%		
150	± 5%	6 800	± 10%		
220	± 5%	10 000	± 10%		
330	± 5%	<b>X7R 25 V</b>			
470	± 5%	Capacitance (pF)	Tolerance		
680	± 5%	15 000	± 10%		
		22 000	± 10%		

48 pieces per value

Ordering code: 4322 044 07121

0805					
NP0 50 V		NP0 25 V		X7R 16 V	
Capacitance (pF)	Tolerance	Capacitance (pF)	Tolerance	Capacitance (pF)	Tolerance
0.47	±0.25pF	3 300	± 5%	150 000	± 10%
0.68	±0.25pF	4 700	± 5%	220 000	± 10%
1	±0.25pF	<b>X7R 50 V</b>		330 000	± 10%
1.5	±0.25pF	Capacitance (pF)	Tolerance	470 000	± 10%
2.2	±0.25pF	220	± 10%	<b>Y5V 50 V</b>	
3.3	±0.25pF	330	± 10%	Capacitance (pF)	Tolerance
4.7	±0.25pF	470	± 10%	10 000	± 20%
6.8	±0.50pF	680	± 10%	22 000	± 20%
10	± 5%	1 000	± 10%	47 000	± 20%
15	± 5%	1 500	± 10%	100 000	± 20%
22	± 5%	2 200	± 10%	220 000	± 20%
33	± 5%	3 300	± 10%	<b>Y5V 16 V</b>	
47	± 5%	4 700	± 10%	Capacitance (pF)	Tolerance
68	± 5%	6 800	± 10%	470 000	± 20%
100	± 5%	10 000	± 10%	1 000 000	± 20%
150	± 5%	15 000	± 10%		
220	± 5%	22 000	± 10%		
330	± 5%	33 000	± 10%		
470	± 5%	47 000	± 10%		
680	± 5%	68 000	± 10%		
1 000	± 5%	100 000	± 10%		
1 500	± 5%				
2 200	± 5%				

48 pieces per value  
 Ordering code: 4322 044 07131

# MLCC Sample Kits

## 1206

1206					
NPO 50 V		NPO 25 V		X7R 16 V	
Capacitance (pF)	Tolerance	Capacitance (pF)	Tolerance	Capacitance (pF)	Tolerance
0.47	±0.25pF	10 000	± 5%	330 000	± 10%
0.68	±0.25pF	<b>X7R 50 V</b>		470 000	± 10%
1	±0.25pF			Capacitance (pF)	Tolerance
1.5	±0.25pF	220	± 10%	1 000 000	± 10%
2.2	±0.25pF	330	± 10%	<b>Y5V 50 V</b>	
3.3	±0.25pF	470	± 10%	Capacitance (pF)	Tolerance
4.7	±0.25pF	680	± 10%	100 000	± 20%
6.8	±0.50pF	1 000	± 10%	220 000	± 20%
10	± 5%	1 500	± 10%	470 000	± 20%
15	± 5%	2 200	± 10%	1 000 000	± 20%
22	± 5%	3 300	± 10%		
33	± 5%	4 700	± 10%		
47	± 5%	6 800	± 10%		
68	± 5%	10 000	± 10%		
100	± 5%	15 000	± 10%		
150	± 5%	22 000	± 10%		
220	± 5%	33 000	± 10%		
330	± 5%	47 000	± 10%		
470	± 5%	68 000	± 10%		
680	± 5%	100 000	± 10%		
1 000	± 5%	150 000	± 10%		
1 500	± 5%	220 000	± 10%		
2 200	± 5%				
3 300	± 5%				
4 700	± 5%				
6 800	± 5%				

48 pieces per value

Ordering code: 4322 044 07141

# MLCC Sample Kits

all sizes, all types, E1 series only

all sizes, all types, E1 series only				
<b>0402</b>		<b>0805</b>		
<b>NPO 50 V</b>		<b>NPO 50 V</b>		
Capacitance (pF)	Tolerance	Capacitance (pF)	Tolerance	
1	±0.25 pF	1	±0.25 pF	
10	± 5%	10	± 5%	
100	± 5%	100	± 5%	
<b>X7R 50 V</b>		1 000	± 5%	
Capacitance (pF)	Tolerance	<b>X7R 50 V</b>		
100	± 10%	Capacitance (pF)	Tolerance	
1 000	± 10%	1 000	± 10%	
<b>X7R 16 V</b>		10 000	± 10%	
Capacitance (pF)	Tolerance	100 000	± 10%	
10 000	± 10%	<b>X7R 10 V</b>		
<b>Y5V 16 V</b>		Capacitance (pF)	Tolerance	
Capacitance (pF)	Tolerance	1 000 000	± 10%	
100 000	± 20%	<b>Y5V 10 V</b>		
		Capacitance (pF)	Tolerance	
		4 700 000	-20/+80%	
<b>0603</b>		<b>1206</b>		
<b>NPO 50 V</b>		<b>NPO 50 V</b>		
Capacitance (pF)	Tolerance	Capacitance (pF)	Tolerance	
1	±0.25 pF	1	±0.25 pF	
10	± 5%	10	± 5%	
100	± 5%	100	± 5%	
<b>X7R 50 V</b>		1 000	± 5%	
Capacitance (pF)	Tolerance	<b>X7R 50 V</b>		
100	± 10%	Capacitance (pF)	Tolerance	
1 000	± 10%	1 000	± 10%	
10 000	± 10%	10 000	± 10%	
<b>X7R 16 V</b>		100 000	± 10%	
Capacitance (pF)	Tolerance	<b>X7R 16 V</b>		
100 000	± 10%	Capacitance (pF)	Tolerance	
<b>Y5V 10 V</b>		1 000 000	± 10%	
Capacitance (pF)	Tolerance	<b>Y5V 10 V</b>		
1 000 000	-20/+80%	Capacitance (pF)	Tolerance	
		10 000 000	-20/+80%	
<b>Microwave 50 V</b>				
Capacitance (pF)	Tolerance	Voltage	Size	Dilectric
1	±0,25pF	50 V	0603	NPO
10	±5%	50 V	0805	NPO
100	±5%	50 V	1206	NPO
<b>Array (4 x 0603)</b>				
Capacitance (pF)	Tolerance	Voltage	Size	Dilectric
100	±5%	50 V	1206	NPO
1 000	±5%	50 V	1206	NPO
10 000	±10%	25 V	1206	X7R
100 000	±10%	16 V	1206	X7R
<b>High voltage</b>				
Capacitance (pF)	Tolerance	Voltage	Size	Dilectric
10	±5%	3 kV	1808	NPO
100	±5%	3 kV	1812	NPO
10 000	±10%	1 kV	1812	X7R

48 Pieces per value (95 pieces for 0402 and 25 pieces for 1812)  
 Ordering code: 4333 045 00581



# Fixed Chip Resistors



# General information

## Standard series of values in a decade according to IEC 63

E6 series:	10	15	22	33	47	68						
E12 series:	10	12	15	18	22	27	33	39	47	56	68	82
E24 series:	10	11	12	13	15	16	18	20	22	24	27	30
	33	36	39	43	47	51	56	62	68	75	82	91
E96 series:	100	102	105	107	110	113	115	118	121	124	127	130
	133	137	140	143	147	150	154	158	162	165	169	174
	178	182	187	191	196	200	205	210	215	221	226	232
	237	243	249	255	261	267	274	280	287	294	301	309
	316	324	332	340	348	357	365	374	383	392	402	412
	422	432	442	453	464	475	487	499	511	523	536	549
	562	576	590	604	619	634	649	665	681	698	715	732
	750	769	787	806	825	845	866	887	909	931	953	976

## Case size dimensions

The first 8 or 9 digits of the 12 digit catalogue number are given under "Ordering information - preferred types" (see following pages).

The remaining 4 or 3 digits represent the resistance value with the last digit indicating the multiplier as shown in the table.

Example:

0.02 Ω = 0200 or 200  
 0.3 Ω = 3007 or 307  
 1 Ω = 1008 or 108  
 33 kΩ = 3303 or 333  
 10 MΩ = 1006 or 106

Last digit of 12 NC	
Resistance	Last digit
0.01 to 0.0976 Ω	0
0.1 to 0.976 Ω	7
1 to 9.76 Ω	8
10 to 97.6 Ω	9
100 to 976 Ω	1
1 to 9.76 kΩ	2
10 to 97.6 kΩ	3
100 to 976 kΩ	4
1 to 9.76 MΩ	5
10 to 68 MΩ	6

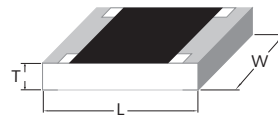

Size code	L (mm)	W (mm)	T (mm)	Mass (g)
0201	0.6	0.3	0.3	0.02
0402	1.0	0.5	0.35	0.06
0603	1.6	0.8	0.45	0.20
0805	2.0	1.25	0.55	0.55
1206	3.2	1.6	0.55	1.0
1218	3.0	4.6	0.44	3.0
2010	5.0	2.5	0.55	2.5
2512	6.4	3.1	0.55	4.25

General Purpose / Precision Resistors											
	SMD					R-Array (note)				R-network	RC-network
	Thick film										
	1206	0805	0603	0402	0201	4 x 0603	8 x 0402	4 x 0402	2 x 0402	1206	1608
5%	RC01	RC11	RC21	RC31	RC41	ARC241 ARV241	ARV381	ARC341 ARV341	ARV321	RNA310	RCB210
1% (TC200)				RC32		ARV242	ARV382		ARV322	RNA310	
1% (TC100)	RC02H	RC12H	RC22H			ARC242					
1% (TC50)	RC02G	RC12G									

TC = Temperature coefficient

Power Resistors		
P <sub>nom</sub> at 70 °C	SMD	
	Thick film	
	5%	1%
0.5 W	PRC111	PRC111
	PRC111 low ohmic	PRC 111 low ohmic
1.0 W	PRC201	PRC201
	PRC201 low ohmic	PRC201 low ohmic
	PRC221	PRC221
	PRC221 low ohmic	PRC221 low ohmic
	LPRC221 low ohmic, low TC	LPRC221 low ohmic, low TC
	VPRC221	

High Precision Resistors						
		Thick film			Thin film	
		0.5%	0.25%	0.1%	0.5%	0.1%
1206	TC100		RC04H	RC05H		
	TC50	RC03G	RC04G	RC05G		
	TC25				TFR01	TFR03
0805	TC100		RC14H	RC15H		
	TC50	RC13G	RC14G	RC15G		
0603	TC100	RC23H	RC24H	RC25H		
0402	TC200	RC33				

Note: ARC : conCave type termination  
ARV : conVex type termination

Application Specific Resistors			
	1206	0805	0603
High ohmic/ High voltage	HRC01	HRC11	HRC21
Low ohmic	LRC01 (5%) LRC02 (1%)	LRC11/11P LRC12/12P	
Fusible	FRC01		FRC21
Surge	SRC01		
Trimmable	RC02TR	RC12TR	RC22TR
High voltage	VRC01 (5%) VRC02 (1%)		
NiAu - termination *	RC01 RC02H		RC21 RC22H

\* = Special termination for hybrid board gluing /  
replace AgPd termination



# Product selection chart

## General Purpose and Precision

General purpose and Precision											
Series	RC01	RC02G	RC02H	RC11	RC12G	RC12H	RC21	RC22H	RC31	RC32	RC41
Case size	1206			0805			0603		0402		0201
Tolerance	5%	1%		5%	1%		5%	1%	5%	1%	5%
Power P <sub>70</sub>	0.25 W			0.125 W			0.1 W		0.063 W		0.05 W
Temp range (°C)	-55 to 155			-55 to 155			-55 to 155		-55 to 125		-55 to 125
U <sub>max</sub>	200 V			150 V			50 V		50 V		15 V
E-Series	E24	E24/E96		E24	E24/E96		E24	E24/E96	E24	E24/E96	E24
Resistance range including temperature coefficient (TC)											
0 Ω	jumper			jumper			jumper		jumper		jumper
0.1 Ω											
1 Ω	1 Ω		1 Ω	1 Ω			1 Ω	1 Ω	1 Ω	1 Ω	
10 Ω	TC 0/+500		TC 0/+500	TC 0/+500			TC 0/+500	TC 0/+500	TC 0/+500	TC 0/+500	10 Ω
100 Ω		90 Ω			90 Ω						TC 0/+500
1 kΩ											
10 kΩ	TC 200	TC 50	TC 100	TC 200	TC 50	TC 100	TC 200	TC 200	TC 200	TC 200	TC 250
100 kΩ											
1 MΩ											
10 MΩ		2.74 MΩ			2.74 MΩ						1 MΩ
100 MΩ	10 MΩ		10 MΩ	10 MΩ		10 MΩ	10 MΩ	10 MΩ	10 MΩ	10 MΩ	
100 MΩ											
Remarks											

Ordering information - preferred types											
Series	RC01	RC02G	RC02H	RC11	RC12G	RC12H	RC21	RC22H	RC31	RC32	RC41
Range	E24 5% 1 Ω-10 MΩ	E24/E96 1% 90 Ω-2.74 MΩ	E24/E96 1% 1 Ω-10 MΩ	E24 5% 1 Ω-10 MΩ	E24/E96 1% 90 Ω-2.74 MΩ	E24/E96 1% 1 Ω-10 MΩ	E24 5% 1 Ω-10 MΩ	E24/E96 1% 1 Ω-10 MΩ	E24 5% 1 Ω-10 MΩ	E24/E96 1% 1 Ω-10 MΩ	E24 5% 10 Ω-1 MΩ
Packing	paper tape	paper tape	paper tape	paper tape	paper tape	paper tape	paper tape	paper tape	paper tape	paper tape	paper tape
Quantity	5 000	2322 711 61...	2322 722 2....	2322 724 6....	2322 730 61...	2322 732 6....	2322 734 6....	2322 702 60...	2322 704 6....	---	---
	10 000	2322 711 51...	2322 722 3....	2322 724 7....	2322 730 71...	2322 732 7....	2322 734 7....	2322 702 70...	2322 704 7....	2322 705 70...	2322 706 7....
	20 000	2322 711 81...	---	2322 724 8....	2322 730 81...	---	2322 734 8....	2322 702 81...	2322 704 8....	---	---
	50 000	---	---	---	---	---	---	---	---	2322 705 87...	2322 706 8....
Jumper	5 000	2322 711 91032	---	2322 724 92006	2322 730 91002	---	2322 734 92006	2322 702 96001	2322 704 92006	---	---
	10 000	2322 711 91005	---	2322 724 92007	2322 730 91003	---	2322 734 92007	2322 702 97001	2322 704 92007	2322 705 91001	---
	20 000	2322 711 92004	---	---	2322 730 92002	---	---	2322 702 92002	---	---	2322 803 91001
	50 000	---	---	---	---	---	---	---	---	2322 705 91007	---
Note	See page 80 for E24/E96 values, the last 4 or 3 digits of the catalogue number and size information										

# Product selection chart

## High Precision

High precision										
Series	RC03G	RC04G	RC04H	RC05G	RC05H	RC13G	RC14G	RC14H	RC15G	RC15H
Case size	1206					0805				
Tolerance	0.5%		0.25%		0.1%		0.5%		0.1%	
Power P <sub>70</sub>	0.25 W		0.125 W			0.125 W		0.10 W		
Temp range (°C)	-55 to 125					-55 to 125				
U <sub>max</sub>	200 V					150 V				
E-Series	E24/E96					E24/E96				
Resistance range including temperature coefficient (TC)										
0 Ω										
0.1 Ω										
1 Ω										
10 Ω										
100 Ω	90 Ω TC 100 250 Ω	90 Ω	100 Ω	90 Ω	100 Ω	90 Ω	90 Ω	100 Ω	90 Ω	100 Ω
1 kΩ										
10 kΩ	TC 50	TC 50	TC 100	TC 50	TC 100	TC 50	TC 50	TC 100	TC 50	TC 100
100 kΩ										
1 MΩ			1 MΩ		1 MΩ			1 MΩ		1 MΩ
10 MΩ	2.74 MΩ	2.74 MΩ		2.74 MΩ		2.74 MΩ	2.74 MΩ		2.74 MΩ	
100 MΩ										
Remarks	thick-film technology									
Ordering information - preferred types										
Series	RC03G	RC04G	RC04H	RC05G	RC05H	RC13G	RC14G	RC14H	RC15G	RC15H
Range	E24/E96 0.5%	E24/E96 0.25%	E24/E96 0.25%	E24/E96 0.1%	E24/E96 0.1%	E24/E96 0.5%	E24/E96 0.25%	E24/E96 0.25%	E24/E96 0.1%	E24/E96 0.1%
Packing	90 Ω-2.74 MΩ paper tape	90 Ω-2.74 MΩ paper tape	100 Ω-1 MΩ paper tape	90 Ω-2.74 MΩ paper tape	100 Ω-1 MΩ paper tape	90 Ω-2.74 MΩ paper tape	90 Ω-2.74 MΩ paper tape	100 Ω-1 MΩ paper tape	90 Ω-2.74 MΩ paper tape	100 Ω-1 MΩ paper tape
Quantity	5 000	2322 725 2.....	2322 707 2.....	2350 541 0.....	2322 708 2.....	2350 542 0.....	2322 738 2.....	2322 709 2.....	2350 544 0.....	2322 710 2.....
Note	See page 80 for E24/E96 values, the last 4 or 3 digits of the catalogue number and size information									

# Product selection chart

## High Precision / High Precision – High Stability

Series	High precision				High Precision – High stability	
	RC23H	RC24H	RC25H	RC33	TFR01	TFR03
Case size	0603			0402	1206	
Tolerance	0.5 %	0.25 %	0.1 %	0.5 %	0.5 %	0.1 %
Power P <sub>70</sub>	0.063 W			0.063 W	0.125 W	
Temp range (°C)	-55 to 125			-55 to 125	-55 to 125	
U <sub>max</sub>	50 V			50 V	100 V	
E-Series	E24/E96			E24/E96	E24/E96	
Resistance range including temperature coefficient (TC)						
0 Ω						
0.1 Ω						
1 Ω						
10 Ω						
100 Ω	100 Ω	100 Ω	100 Ω	100 Ω	100 Ω	100 Ω
1 kΩ					TC 25	TC 25
10 kΩ	TC 100	TC 100	TC 100	TC 200		
100 kΩ					10 kΩ	10 kΩ
1 MΩ	1 MΩ	1 MΩ	1 MΩ	1 MΩ		
10 MΩ						
100 MΩ						
Remarks	thick-film technology				thin-film technology	
<b>Ordering information - preferred types</b>						
Series	RC23H	RC24H	RC25H	RC33	TFR01	TFR03
Range	E24/E96	E24/E96	E24/E96	E24/E96	E96	E96
	0.5 %	0.25 %	0.1 %	0.5 %	0.5 %	0.1 %
	100 Ω-1 MΩ	100 Ω-1 MΩ	100 Ω-1 MΩ	100 Ω-1 MΩ	100 Ω-1 kΩ	100 Ω-1 kΩ
Packing	paper tape	paper tape	paper tape	paper tape	paper tape	paper tape
Quantity	5 000	2350 546 0....	2350 548 0....	---	2350 611 6....	2350 611 4....
	10 000	---	---	2350 549 7....	---	---
Note	See page 80 for E24/E96 values, the last 4 or 3 digits of the catalogue number and size information					

# Product selection chart

## Arrays

Arrays											
Series	ARC241	ARV241	ARC242	ARV242	ARV321	ARV322	ARC341	ARV341	ARV381	ARV382	
Case size	4 x 0603 (3.2 x 1.6 mm)				2 x 0402 (1.0 x 1.0 mm)		4 x 0402 (2.0 x 1.0 mm)		8 x 0402 (4.0 x 1.6 mm)		
Tolerance	5%		1%		5%		1%		5%		
Power P <sub>70</sub>	0.063 W				0.063 W		0.063 W		0.063 W		
Temp range (°C)	-55 to 155				-55 to 125		-55 to 125		-55 to 125		
U <sub>max</sub>	50 V				50 V		50 V		25 V		
E-Series	E24		E96		E24		E96		E24		
Resistance range including temperature coefficient (TC)	0 Ω	jumper	jumper			jumper			jumper	jumper	
	0.1 Ω										
	1 Ω										
	10 Ω	10 Ω	10 Ω	10 Ω	10 Ω	10 Ω	10 Ω	10 Ω	10 Ω	10 Ω	
	100 Ω										
	1 kΩ	TC 200	TC 200	TC 100	TC 200	TC 200	TC 200	TC 200	TC 300	TC 200	TC 200
	10 kΩ										
	100 kΩ									100 kΩ	100 kΩ
	1 MΩ	1 MΩ	1 MΩ	1 MΩ	1 MΩ	1 MΩ	1 MΩ	1 MΩ	1 MΩ		
	10 MΩ										
100 MΩ											
Remarks	Concave terminations	Convex terminations	Concave terminations	Convex terminations	Convex terminations	Convex terminations	Concave terminations	Convex terminations	Convex terminations	Convex terminations	
Ordering information - preferred types											
Series	ARC241	ARV241	ARC242	ARV242	ARV321	ARV322	ARC341	ARV341	ARV381	ARV382	
Range	E24 5% 10 Ω-1 MΩ	E24 5% 10 Ω-1 MΩ	E96 1% 10 Ω-1 MΩ	E24/E96 1% 10 Ω-1 MΩ	E24 5% 10 Ω-1 MΩ	E24/E96 1% 10 Ω-1 MΩ	E24 5% 10 Ω-1 MΩ	E24 5% 10 Ω-1 MΩ	E24 5% 10 Ω-100 kΩ	E24 1% 10 Ω-100 kΩ	
Packing	paper tape	paper tape	paper tape	paper tape	paper tape	paper tape	paper tape	paper tape	paper tape	paper tape	
Quantity	5 000	2350 034 10...	2350 035 10...	2350 024 1....	2350 025 1....	---	---	2350 032 10...	2350 033 10...	2350 053 10...	2350 043 1....
	10 000	---	---	---	---	2350 013 11...	2350 013 2....	2350 032 11...	2350 033 11...	---	---
	5 000	2350 034 91001	2350 035 91001	---	---	2350 013 91002	---	---	2350 033 91002	2350 053 91001	---
Jumper	10 000	---	---	---	---	2350 013 91001	---	---	2350 033 91001	---	---
Note	See page 80 for E24/E96 values, the last 4 or 3 digits of the catalogue number and size information										

# Product selection chart

## R-Networks / RC-Network

	R-Networks		RC-Network
Series	RNA310	RNA310	RCB210
Case size	8R-network (3.3 x 1.6 mm)		RC-network (5.1 x 3.4mm)
Tolerance	5%	1%	5%
Power P <sub>70</sub>	0.031 W		0.063 W
Temp range (°C)	-55 to 125		-25 to 85
U <sub>max</sub>	25 V		25 V
E-Series	E24	E24/E96	E6
Resistance range including temperature coefficient (TC)			
0 Ω	jumper		
0.1 Ω			
1 Ω			
10 Ω	10 Ω TC 0/+500	10 Ω TC 0/+500	10 Ω
100 Ω			TC 200
1 kΩ	TC 200	TC 200	1kΩ
10 kΩ			
100 kΩ	100 kΩ	100 kΩ	
1 MΩ			
10 MΩ			
100 MΩ			
Remarks	Convex terminations		Concave terminations
<b>Ordering information - preferred types</b>			
Series	RNA310	RNA310	RCB210
Range	E24 5% 10 Ω - 100 kΩ	E24/E96 1% 10 Ω - 100 kΩ	E6 5% 10 Ω - 1 kΩ
Packing	paper tape		blister tape
Quantity	4 000 5 000	---	2350 321 ..... (*)
Jumper	2350 230 10...	2350 230 2....	---
	2350 230 91001	---	---
<b>Note</b>	See page 80 for E24/E96 values, the last 4 or 3 digits of the catalogue number and size information (**) see for last 5 digits (R-value/C-value) in datasheet)		

# Product selection chart

## Power / Power, Low Ohmic

Series	Power						Power - low ohmic								
	PRC111		PRC201		PRC221		PRC111		PRC201		PRC221				
Case size	2010		1218		2512		2010		1218		2512				
Tolerance	5%	1%	5%	1%	5%	1%	5%	1%	5%	1%	5%	1%			
Power P <sub>70</sub>	0.5W		1.0 W		1.0 W		0.5 W		1.0 W		1.0 W				
Temp range (°C)	-55 to 125		-55 to 125		-55 to 125		-55 to 125		-55 to 125		-55 to 125				
U <sub>max</sub>	200 V		200 V		250 V		200 V		200 V		250 V				
E-Series	E24	E96	E24	E96	E24	E96	E24	E96	E24	E96	E24	E96			
Resistance range including temperature coefficient (TC)	0 Ω	jumper		jumper		0.01 Ω		0.02 Ω		0.01 Ω		0.05 Ω			
		TC 2000 to TC 300		TC 2000 to TC 300		TC 2000 to TC 300		TC 2000 to TC 300		TC 2000 to TC 250		TC 1500 to TC 75		TC 2000 to TC 300	
	0.1 Ω	1 Ω		1 Ω		1 Ω		1 Ω		1 Ω		1 Ω		1 Ω	
		TC 300		TC 300		TC 200		TC 200		TC 300		TC 300		TC 300	
	1 Ω	TC 200		TC 200		TC 200		TC 200		TC 200		TC 200		TC 200	
		TC 300		TC 300		TC 200		TC 200		TC 300		TC 300		TC 300	
	10 Ω	TC 100		TC 100		TC 100		TC 100		TC 100		TC 100		TC 100	
	100 Ω	TC 100		TC 100		TC 100		TC 100		TC 100		TC 100		TC 100	
	1 kΩ	TC 100		TC 100		TC 100		TC 100		TC 100		TC 100		TC 100	
	10 kΩ	TC 100		TC 100		TC 100		TC 100		TC 100		TC 100		TC 100	
	100 kΩ	TC 100		TC 100		TC 100		TC 100		TC 100		TC 100		TC 100	
	1 MΩ	TC 200		TC 200		1 MΩ		1 MΩ		TC 200		TC 200		TC 200	
10 MΩ	10 MΩ		10 MΩ		10 MΩ		10 MΩ		10 MΩ		10 MΩ		10 MΩ		
100 MΩ	10 MΩ		10 MΩ		10 MΩ		10 MΩ		10 MΩ		10 MΩ		10 MΩ		
<b>SURGE POWER ON REQUEST</b>															
Remarks			Termination on the long side improve heat transfer and reduce stresses						Termination on the long side improve heat transfer and reduce stresses						
<b>Ordering information - preferred types</b>															
Series	PRC111		PRC201		PRC221		PRC111		PRC201		PRC221				
Range	E24 5%	E96 1%	E24 5%	E96 1%	E24 5%	E96 1%	E24 5%	E24/E96 1%	E24 5%	E24/E96 1%	E24 5%	E24/E96 1%			
Packing	1 Ω-10 MΩ	1 Ω-10 MΩ	1 Ω-1 MΩ	1 Ω-1 MΩ	1 Ω-10 MΩ	1 Ω-10 MΩ	0.01 Ω-0.976 Ω	0.02 Ω-0.976 Ω	0.01 Ω-0.976 Ω	0.05 Ω-0.976 Ω	0.01 Ω-0.976 Ω	0.05 Ω-0.976 Ω			
Quantity	blister tape	blister tape	blister tape	blister tape	blister tape	blister tape	blister tape	blister tape	blister tape	blister tape	blister tape	blister tape			
4 000	2322 760 60...	2322 761 6...	---	---	2322 762 60...	2322 763 6...	2322 760 90./60.7	2322 761 90./6...7	---	---	2322 762 90./60.7	2322 763 90./6...7			
5 000	---	---	2322 735 60...	2322 735 2....	---	---	---	---	2322 735 60...	2322 735 2....	---	---			
Jumper	4 000	2322 760 90003	---	---	2322 762 90000	---	---	---	---	---	---	---			
5 000	---	---	2322 735 90006	---	---	---	---	---	---	---	---	---			
Note	See page 80 for E24/E96 values, the last 4 or 3 digits of the catalogue number and size information														

# Product selection chart

## Power, Low Ohmic, Low TC / High Voltage

Series	Power – low ohmic – low TC		High voltage		
	LPRC221		VPRC221	VRC01	VRC02
Case size	2512		2512	1206	
Tolerance	5%	1%	5%	5%	1%
Power P <sub>70</sub>	1.0 W		1.0 W	0.25 W	
Temp range (°C)	-55 to 125		-55 to 125	-55 to 125	
U <sub>max</sub>	250 V		250 V	400 V	
E-Series	all series	all series	E24	E24	E96
Resistance range including temperature coefficient (TC)					
0 Ω	0.02 Ω	0.02 Ω			
0.1 Ω	TC 300	TC 300			
	TC 200	TC 200			
1 Ω	0.100 Ω	0.100 Ω			
10 Ω					
100 Ω					
1 kΩ					
10 kΩ					
100 kΩ				100 kΩ	100 kΩ
1 MΩ			4.7 MΩ	TC 300	TC 300
10 MΩ			TC 200		
100 MΩ			16 MΩ	27 MΩ	10 MΩ
Remarks	Special Resistor material for low TC		Max. overload voltage 2500V for 1 min.	Max. overload voltage 400V for 1 min.	
<b>Ordering information - preferred types</b>					
Series	LPRC221		VPRC221	VRC01	VRC02
Range	all series 5%	all series 1%	E24 5%	E24 5%	E96 1%
	0.020 Ω-0.100 Ω	0.020 Ω-0.100 Ω	4.7 MΩ-16 MΩ	100 kΩ-27 MΩ	100 kΩ-10 MΩ
Packing	blister tape	blister tape	blister tape	paper tape	paper tape
Quantity	4 000 5 000	2322 802 60...0/60107 ---	2322 802 7...0/71007 ---	2322 762 98... ---	---
	---	---	---	2322 790 61...	2322 791 6...
<b>Note</b>	See page 80 for E24/E96 values, the last 4 or 3 digits of the catalogue number and size information				

# Product selection chart

## High Ohmic / Low Ohmic

Series	High ohmic			Low ohmic					
	HRC01	HRC11	HRC21	LRC01	LRC02	LRC11	LRC12	LRC11P	LRC12P
Case size	<b>1206</b>	<b>0805</b>	<b>0603</b>	<b>1206</b>		<b>0805</b>		<b>0805</b>	
Tolerance	5%	5%	5%	5%	1%	5%	1%	5%	1%
Power P <sub>70</sub>	0.25 W	0.125 W	0.1 W	0.25 W		0.125 W	0.1 W	0.25 W	
Temp range (°C)	-55 to 125	-55 to 125	-55 to 155	-55 to 125		-55 to 125		-55 to 125	
U <sub>max</sub>	200 V	150 V	50 V	200 V		150 V		150 V	
E-Series	E24	E24	E24	E24	E96	E24	E96	E24	E96
Resistance range including temperature coefficient (TC)									
0 Ω				0.02 Ω	0.02 Ω	0.02 Ω	0.02 Ω	0.02 Ω	0.02 Ω
0.1 Ω				TC 1500 to TC 75	TC 1500 to TC 75	TC 1500 to TC 75	TC 1500 to TC 75	TC 1500 to TC 75	TC 1500 to TC 75
1 Ω				0.976 Ω	0.976 Ω	0.976 Ω	0.976 Ω	0.976 Ω	0.976 Ω
10 Ω									
100 Ω									
1 kΩ									
10 kΩ									
100 kΩ									
1 MΩ									
10 MΩ	11 MΩ TC 250	11 MΩ TC 300	11 MΩ TC 300						
100 MΩ	30 MΩ	30 MΩ	22 MΩ						
Remarks									
<b>Ordering information</b>									
Series	HRC01	HRC11	HRC21	LRC01	LRC02	LRC11	LRC12	LRC11P	LRC12P
Range	E24 5% 11 MΩ-30 MΩ	E24 5% 11 MΩ-30 MΩ	E24 5% 11 MΩ-22 MΩ	E24 5% 0.02 Ω-0.976 Ω	E96 1% 0.02 Ω-0.976 Ω	E24 5% 0.02 Ω-0.976 Ω	E96 1% 0.02 Ω-0.976 Ω	E24 5% 0.02 Ω-0.976 Ω	E96 1% 0.02 Ω-0.976 Ω
Packing	paper tape	paper tape	paper tape	paper tape	paper tape	paper tape	paper tape	paper tape	paper tape
Quantity	5 000	2350 520 10...	2350 521 10...	2350 522 10...	2350 510 10...	2350 510 12...	2350 511 10...	2350 510 12...	2350 511 15...
Note	See page 80 for E24/E96 values, the last 4 or 3 digits of the catalogue number and size information								



# Product selection chart

## Trimmable / Surge / Fusible / NiAu Termination

Series	Trimmable			Surge	Fusible		NiAu termination			
	RC02TR	RC12TR	RC22TR	SRC01	FRC01	FRC21	RC01	RC02H	RC21	RC22H
Case size	1206	0805	0603	1206	1206	0603	1206		0603	
Tolerance				5%	5%	5%	5%	1%	5%	1%
Power P <sub>70</sub>	0.25 W	0.125 W	0.063 W	0.25 W	0.125 W	0.063 W	0.25 W		0.063 W	
Temp range (°C)	-55 to 155	-55 to 155	-55 to 125	-55 to 155	-55 to 125	-55 to 155	-55 to 155		-55 to 155	
U <sub>max</sub>	200 V	150 V	50 V	200 V	200 V	50 V	200 V		50 V	
E-Series	E24	E24	E24	E24	E24/E96	E24	E24	E24/E96	E24	E96
Resistance range including temperature coefficient (TC)										
0 Ω										
0.1 Ω										
1 Ω	1 Ω	1 Ω	1 Ω	1 Ω	1 Ω	1 Ω	1 Ω	1 Ω	1 Ω	1 Ω
10 Ω	TC 0/+500	TC 0/+500	TC 0/+500		TC 250 4.7 Ω	TC 0/+500	TC 0/+500	TC 0/+500	TC 0/+500	TC 0/+500
100 Ω					TC 200	TC 200				
1 kΩ	TC 100	TC 100	TC 100	TC 200	510 Ω	240 Ω	TC 200	TC 200	TC 200	TC 200
10 kΩ										
100 kΩ				100 kΩ						
1 MΩ										
10 MΩ	TC 200	TC 200	TC 200							
100 MΩ	10 MΩ	10 MΩ	10 MΩ				10 MΩ	10 MΩ	10 MΩ	10 MΩ
	for Europe code numbers on request									
Remarks	tolerance 0 / -20% 0 / -30%			non flammable specified interruptions			Special termination for hybrid board gluing / replace AgPd termination			
Ordering information										
Series	RC02TR	RC12TR	RC22TR	SRC01	FRC01	FRC21	RC01	RC02H	RC21	RC22H
Range	E24 1 Ω-10 MΩ	E24 1 Ω-10 MΩ	E24 1 Ω-10 MΩ	E24 5% 1 Ω-100 kΩ	E24/E96 5% 1 Ω-510 Ω	E24 5% 1 Ω-240 Ω	E24 5% 1 Ω-10 MΩ	E24/E96 1% 1 Ω-10 MΩ	E24 5% 1 Ω-10 MΩ	E96 1% 1 Ω-10 MΩ
Packing	paper tape	paper tape	paper tape	paper tape	paper tape	paper tape	paper tape	paper tape	paper tape	paper tape
Quantity	5 000	on request	on request	2350 550 10...	2322 750 6...	2322 756 60...	2322 711 11...	2322 729 1...	2322 702 11...	2322 704 1...
	10 000	---	---	---	---	---	---	---	2322 702 12...	---
Note	See page 80 for E24/E96 values, the last 4 or 3 digits of the catalogue number and size information									

# Product selection chart

## R-Chip Engineering Design Kits (Binders)

Sample kit data					
Phycomp order code: 3322 073 .....	30092	30095	30093	30096	30094
Type	RC01	RC01	RC11	RC11	RC21
Size	1206	1206	0805	0805	0603
Series	E6+OR	E24+OR	E6+OR	E24+OR	E6+OR
Resistor Range	1 Ω - 10 MΩ	1 Ω - 10 MΩ	1 Ω - 10 MΩ	1 Ω - 10 MΩ	1 Ω - 10 MΩ
Resistance Values	38	170	38	170	38
Resistor pieces	50	50	50	50	50
Maximum Wattage	1/4 W	1/4 W	1/10 W	1/10 W	1/16 W
Temp Coeff (ppm)	± 200	± 200	± 200	± 200	± 200
Maximum Voltage	200	200	150	150	50

Sample kit data					
Phycomp order code: 3322 073 .....	30098	30099	30101	30111	30107
Type	RC02H	RC12H	RC22H	RC22H	RC32H
Size	1206	0805	0603	0603	0402
Series	E24+OR	E24+OR	E24+OR	E96	E12+OR
Resistor Range	1 Ω - 10 MΩ	1 Ω - 10 MΩ	1 Ω - 10 MΩ	1 Ω - 10 MΩ	10 Ω - 1 MΩ
Resistance Values	170	170	170	658	62
Resistor pieces	50	50	50	50	100
Maximum Wattage	1/4 W	1/10 W	1/16 W	1/16 W	1/16 W
Temp Coeff (ppm)	± 100	± 100	± 100	± 100	± 200
Maximum Voltage	200	150	50	50	50

Sample kit data				
Phycomp order code: 3322 073 .....	30097	30104	30105	30106
Type	RC21	RC31	RC31	RC31
Size	0603	0402	0402	0402
Series	E24+OR	E12+OR	E24-E12	E24+OR
Resistor Range	1 Ω - 10 MΩ	10 Ω - 2M2 Ω	10 Ω - 2M2 Ω	10 Ω - 2M2 Ω
Resistance Values	170	62	62	122
Resistor pieces	50	100	100	100
Maximum Wattage	1/16 W	1/16 W	1/16 W	1/16 W
Temp Coeff (ppm)	± 200	± 200	± 200	± 200
Maximum Voltage	50	50	50	50

Sample kit data				
Phycomp order code: 3322 073 .....	30108	30109	30102	30103
Type	RC32H	RC32H	ARC241	ARC241
Size	0402	0402	0603X4	0603X4
Series	E24-E12	E24+OR	E6+OR	E12+OR
Resistor Range	10 Ω - 1 MΩ	10 Ω - 1 MΩ	10 Ω - 1 MΩ	10 Ω - 1 MΩ
Resistance Values	61	122	32	62
Resistor pieces	100	100	50	50
Maximum Wattage	1/16 W	1/16 W	1/16 W	1/16 W
Temp Coeff (ppm)	± 200	± 200	± 200	± 200
Maximum Voltage	50	50	50	50