

Kyocera's series of Multilayer Ceramic Chip Capacitors are designed to meet a wide variety of needs. We offer a complete range of products for both general and specialized applications, including the general-purpose CM series, the high-voltage CF series, the low profile CT series, and the DM series for automotive uses.

Features

- We have factories worldwide in order to supply our global customer bases quickly and efficiently and to maintain our reputation as one of the highest-volume producers in the industry.
- All our products are highly reliable due to their monolithic structure of high-purity and superfine uniform ceramics and their integral internal electrodes.
- By combining superior manufacturing technology and materials with high dielectric constants, we produce extremely compact components with exceptional specifications.
- Our stringent quality control in every phase of production from material procurement to shipping ensures consistent manufacturing and super quality.
- Kyocera components are available in a wide choice of dimensions, temperature characteristics, rated voltages, and terminations to meet specific configurational requirements.

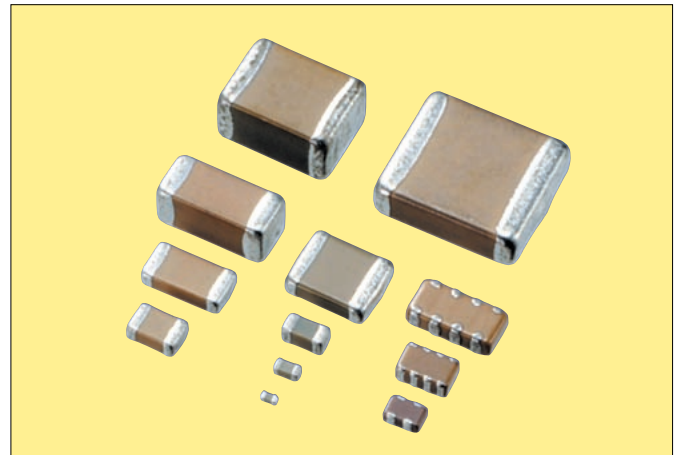

Ph Free

RoHS Compliant

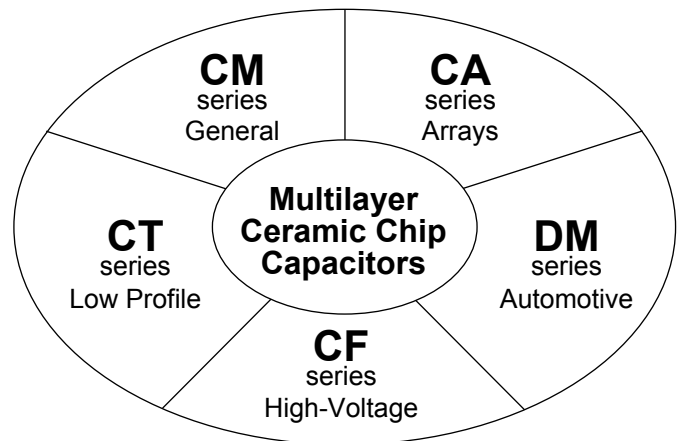

Structure

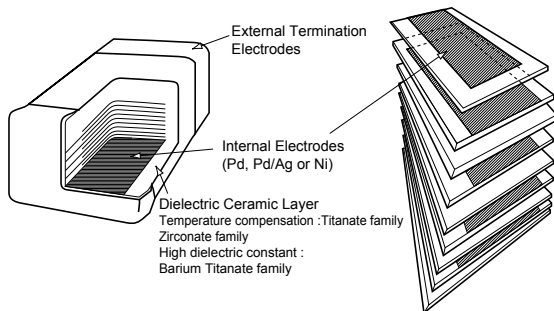

Nickel Barrier Termination Products

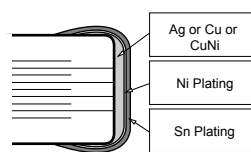

Tape and Reel



Bulk Cassette

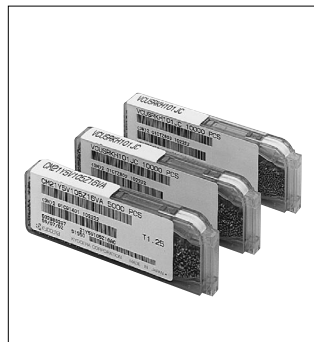

Please contact your local AVX, Kyocera sales office or distributor for specifications not covered in this catalog.

Our products are continually being improved. As a result, the capacitance range of each series is subject to change without notice. Please contact a sales representative to confirm compatibility with your application.

Kyocera Ceramic Chip Capacitors are available for different applications as classified below:

Series	Dielectric Options	Typical Applications	Features	Terminations	Available Size
CM	C0G (NP0) X5R X7R *X6S *X7S Y5V	General Purpose	Wide Cap Range	Nickel Barrier	0201, 0402, 0603 0805, 1206, 1210 1812
CF	C0G (NP0) X7R	High Voltage & Power Circuits	High Voltage 250VDC, 630VDC 1000VDC, 2000VDC 3000VDC, 4000VDC	Nickel Barrier	0805, 1206, 1210 1812, 2208, 1808 2220
CT	C0G (NP0) X5R X7R Y5V	PLCC (Decoupling)	Low Profile	Nickel Barrier	0402, 0603, 0805 1206, 1210
DM	X7R	Automotive	Thermal shock Resistivity High Reliability	Nickel Barrier	0603, 0805, 1206
CA	C0G (NP0) X5R, X7R	Digital Signal Pass line	Reduction in Placing Costs	Nickel Barrier	0405, 0508

* option

Dimensions

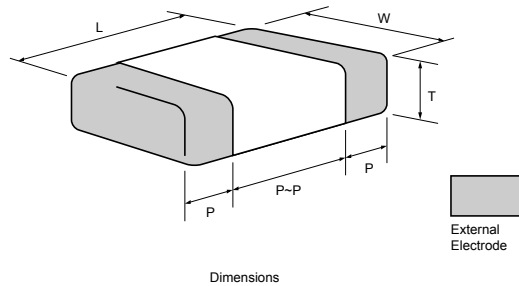

Tape & Reel

Size	EIA CODE	EIAJ CODE	Dimensions (mm)					
			L	W	P min.	P max.	P to P min.	T max.
03	0201	0603	0.6±0.03	0.3±0.03	0.13	0.23	0.20	0.33
05	0402	1005	1.0±0.05	0.5±0.05	0.15	0.35	0.30	0.55
105	0603	1608	1.6±0.10	0.8±0.10	0.20	0.60	0.50	0.90
21	0805	2012	2.0±0.10	1.25±0.10	0.20	0.75	0.70	1.35
316	1206	3216	3.2±0.20	1.60±0.15	0.30	0.85	1.40	1.75
32	1210	3225	3.2±0.20	2.50±0.20	0.30	1.00	1.40	2.70
42	1808	4520	4.5±0.20	2.00±0.20	0.15	0.85	2.60	2.20
43	1812	4532	4.5±0.30	3.20±0.20	0.30	1.10	2.00	3.0
52	2208	5720	5.7±0.40	2.00±0.20	0.15	0.85	4.20	2.20
53	2211	5728	5.7±0.40	2.80±0.20	0.15	0.85	4.20	2.80
55	2220	5750	5.7±0.40	5.00±0.40	0.30	1.40	2.50	2.70

- T (Thickness) depends on capacitance value.
Standard thickness is shown on the appropriate product pages.
- CA series (please refer applicable page)

Bulk Cassette

Size	EIA CODE	EIAJ CODE	L	W	T	P		P to P
						min.	max.	min.
05	0402	1005	1.0±0.05	0.5±0.05	0.5±0.05	0.15	0.35	0.30
105	0603	1608	1.6±0.07	0.8±0.07	0.8±0.07	0.20	0.60	0.50
21	0805	2012	2.0±0.1	1.25±0.1	1.25±0.1	0.20	0.75	0.70

Note) Regarding support for Bulk cases, please contact us for further information.



KYOCERA PART NUMBER:

CM 21 X7R 104 K 50 A T

SERIES CODE

CM = General Purpose CA = Capacitor Arrays
 CF = High Voltage
 CT = Low Profile
 DM = Automotive

SIZE CODE

SIZE EIA (EIAJ)	SIZE EIA (EIAJ)	SIZE EIA (EIAJ)
03 = 0201 (0603)	21 = 0805 (2012)	52 = 2208 (5720)
05 = 0402 (1005)	316 = 1206 (3216)	53 = 2218 (5732)
105 = 0603 (1608)	32 = 1210 (3225)	55 = 2220 (5750)
F12 = 0508 (1220)/4cap	42 = 1808 (4520)	D11 = 0405 (1012)/2cap
	43 = 1812 (4532)	D12 = 0508 (1220)/2cap

DIELECTRIC CODE

CODE	EIA CODE	
CG = C0G (NPO)	X7S = X7S (Option)	
X5R = X5R	X6S = X6S (Option)	
X7R = X7R	Y5V = Y5V	

Negative dielectric types are available on request.

CAPACITANCE CODE

Capacitance expressed in pF. 2 significant digits plus number of zeros.
 For Values < 10pF, Letter R denotes decimal point,
 eg. 100000pF = 104 1.5pF = 1R5
 0.1µF = 104 0.5pF = R50
 4700pF = 472 100µF = 107

TOLERANCE CODE

A = ±0.05pF (option)	D = ±0.5pF	J = ±5%	Z = -20 to +80%
B = ±0.1pF (option)	F = ±1pF	K = ±10%	
C = ±0.25pF	G = ±2%	M = ±20%	

VOLTAGE CODE

04 = 4VDC	100 = 100VDC	1000 = 1000VDC
06 = 6.3VDC	250 = 250VDC	2000 = 2000VDC
10 = 10VDC	400 = 400VDC	3000 = 3000VDC
16 = 16VDC	630 = 630VDC	4000 = 4000VDC
25 = 25VDC		
35 = 35VDC		
50 = 50VDC		

TERMINATION CODE

A = Nickel Barrier

PACKAGING CODE

B = Bulk	L = 13" Reel Taping & 4mm Cavity pitch
C = Bulk Cassette (option)	H = 7" Reel Taping & 2mm Cavity pitch
T = 7" Reel Taping & 4mm Cavity pitch	N = 13" Reel Taping & 2mm Cavity pitch

OPTION

Thickness max value is indicated in CT series
 EX. 125 → 1.25mm max.
 095 → 0.95mm max.



High Dielectric Constant

EIA Dielectric	Temperature Range	ΔC_{max}
X5R	-55 to 85°C	±15%
X7R	-55 to 125°C	
X7S	-55 to 125°C	±22%
X6S	-55 to 105°C	
Y5V	-30 to 85°C	-82 to +22%

Temperature Compensation Type

Electric Code Value (pF)	C0G	UΔ N750	SL +350 to -1000
0.5-2.7	CK	UK	SL
3.0-3.9	CJ	UJ	SL
4.0-9.0	CH	UJ	SL
≥10	CG	UJ	SL

K = ±250ppm/°C, J = ±120ppm/°C, H = ±60ppm/°C, G = ±30ppm/°C
 e.g. CG = 0±30ppm/°C

Note: All parts will be marked as "CG" but will conform to the above table.

Available Tolerances

Dielectric materials, capacitance values and tolerances are available in the following combinations only:

EIA Dielectric	Tolerance	Capacitance	
C0G	C=±0.25pF D=±0.50pF F=±1pF	*1 <10pF	
	*3 A=±0.05pF B=±0.1pF	<0.5pF ≤5pF	
	G=±2% J=±5% K=±10%	≥10pF E12 Series	
	X5R X6R X7R	*2 K=±10% M=±20%	E6 Series
	Y5V	Z=-20% to +80%	E3 Series

Note:

*1 Nominal values below 10pF are available in the standard values of 0.5pF, 1.0pF, 1.5pF, 2.0pF, 3.0pF, 4.0pF, 5.0pF, 6.0pF, 7.0pF, 8.0pF, 9.0pF

*2 J = ±5% for X7R(X5R) is available on request.

*3 option

E Standard Number

E3	E6	E12	E24 (Option)		
1.0	1.0	1.0	1.0	1.1	
		1.2	1.2	1.3	
	1.5	1.5	1.5	1.6	
		1.8	1.8	2.0	
2.2	2.2	2.2	2.2	2.4	
		2.7	2.7	3.0	
	3.3	3.3	3.3	3.6	
		3.9	3.9	4.3	
	4.7	4.7	4.7	4.7	5.1
			5.6	5.6	6.2
6.8		6.8	6.8	7.5	
		8.2	8.2	9.1	

Features

We offer a diverse product line ranging from ultra-compact (0.6×0.3 mm) to large (5.7×5.0 mm) components configured for a variety of temperature characteristics, rated voltages, and packages. We offer the choice and flexibility for almost any applications.

Applications

This standard type is ideal for use in a wide range of applications, from commercial to industrial equipment.

Temperature Compensation Dielectric

Size (EIA Code)	CM03 (0201)			CM05 (0402)			CM105 (0603)		CM21 (0805)						
Temperature Characteristics	C Δ	U Δ	SL	C Δ		U Δ	SL	C Δ	C Δ						
Rated Voltage (VDC)	25	16	25	25	16	25	50	50	50	100	16	25	50	100	
Capacitance (pF)	25	16	25	25	16	25	50	50	50	100	16	25	50	100	
R20	0.2														
R50	0.5	A													
1R0	1.0														
1R5	1.5														
	2.0														
	3.0														
	4.0														
	5.0														
	6.0														
	7.0														
	8.0	A													
	9.0														
100	10														
120	12														
	15														
	16														
	22														
	27														
	33														
	39														
	47														
	56														
	68														
	82														
101	100														
121	120														
	150														
	180														
	220														
	270														
	330														
	390														
	470														
	560														
	680														
	820														
102	1000														
122	1200														
	1500														
	1800														
	2200														
	2700														
	3300														
	3900														
	4700														
	5600														
	6800														
	8200														
103	10000														
123	12000														
	15000														
	18000														

Thickness and standard package quantity

Size	*03	*05	105	*105	21, 316, 32									
Thickness (mm)	A	B	C	C	D	E	F	G	H	I	J	K	L	
	0.3±0.03	0.5±0.05	0.8±0.1	0.8±0.1	0.6±0.1	0.85±0.1	1.15±0.1	1.25±0.1	1.4max.	1.6max.	1.6±0.15	2.0±0.2	2.5±0.2	
Taping (180 dia reel)	15kp(P8)	10kp(P8)	4kp(P8)	8kp(P8)	4kp(P8)	4kp(P8)	3kp(E8)	3kp(E8)	3kp(E8)	2.5kp(E8)	2.5kp(E8)	2kp(E8)	1kp(E8)	
Taping (330 dia reel)	50kp(P8)	50kp(P8)	10kp(P8)	20kp(P8)	10kp(P8)	10kp(P8)	10kp(E8)	10kp(E8)	10kp(E8)	5kp(E8)	5kp(E8)	5kp(E8)	—	

Size	43			
Thickness (mm)	J	K	L	M
	1.6±0.15	2.0±0.2	2.5±0.2	2.8±0.2
Taping (180 dia reel)	1kp(E12)	1kp(E12)	0.5kp(E12)	0.5kp(E12)
Taping (330 dia reel)	—	—	—	—

Note : P8 = 8mm width paper tape
E8 = 8mm width plastic tape
E12 = 12mm width plastic tape
* Carrier tape 2mm pitch from one capacitor to another.

X5R Dielectric

Size (EIA Code)	CM03 (0201)					CM05 (0402)						CM105 (0603)						CM21 (0805)							
	4	6.3	10	16	25	4	6.3	10	16	25	50	4	6.3	10	16	25	50	4	6.3	10	16	25	50		
101																									
151					A																				
102				A																					
152			A	A																					
103																									
153																									
104																									
154																									
105																									
155																									
106																									
156																									

Size (EIA Code)	CM316 (1206)					CM32 (1210)						CM43 (1812)		
	6.3	10	16	25	50	4	6.3	10	16	25	50	6.3	50	
104														
105														
106														
107														

▨ Optional Spec.

X7R, Dielectric

Size (EIA Code)	CM03 (0201)		CM05 (0402)			CM105 (0603)						CM21 (0805)						
	10	16	16	25	50	6.3	10	16	25	50	100	6.3	10	16	25	50	100	
101	100																	
151	150																	
	220																	
	330																	
	470																	
	680																	
102	1000																	
152	1500																	
	2200																	
	3300																	
	4700																	
	6800																	
103	10000																	
153	15000																	
	22000																	
	33000																	
	47000																	
	68000																	
104	100000																	
154	150000																	
	220000																	
	330000																	
	470000																	
	680000																	
105	1000000																	
155	1500000																	
	2200000																	
	3300000																	
	4700000																	
106	10000000																	

Size (EIA Code)	CM316 (1206)						CM32 (1210)				CM43 (1812)		
	6.3	10	16	25	50	100	10	16	25	50	100	50	100
103	10000												
	22000												
	47000												
104	100000												
	220000												
	470000												
105	1000000												
	2200000												
	4700000												
106	10000000												
	22000000												

Y5V Dielectric

Size (EIA Code)	CM03 (0201)		CM05 (0402)			CM105 (0603)				CM21 (0805)				CM316 (1206)			CM32 (1210)				
	6.3	10	10	16	25	50	10	16	25	50	10	16	25	50	10	16	25	10	16	25	
102	1000																				
	2200																				
	4700																				
103	10000																				
	22000																				
	47000																				
104	100000																				
	220000																				
	470000																				
105	1000000																				
	2200000																				
	4700000																				
106	10000000																				
	22000000																				
	47000000																				

Thickness and standard package quantity

Size	*03	*05	105	*105	21, 316, 32									
	A	B	C	C	D	E	F	G	H	I	J	K	L	
Thickness (mm)	0.3±0.03	0.5±0.05	0.8±0.1	0.8±0.1	0.6±0.1	0.85±0.1	1.15±0.1	1.25±0.1	1.4max.	1.6max.	1.6±0.15	2.0±0.2	2.5±0.2	
Taping (180 dia reel)	15kp(P8)	10kp(P8)	4kp(P8)	8kp(P8)	4kp(P8)	4kp(P8)	3kp(E8)	3kp(E8)	3kp(E8)	2.5kp(E8)	2.5kp(E8)	2kp(E8)	1kp(E8)	
Taping (330 dia reel)	50kp(P8)	50kp(P8)	10kp(P8)	20kp(P8)	10kp(P8)	10kp(P8)	10kp(E8)	10kp(E8)	10kp(E8)	5kp(E8)	5kp(E8)	5kp(E8)	—	

Size	43			
	J	K	L	M
Thickness (mm)	1.6±0.15	2.0±0.2	2.5±0.2	2.8±0.2
Taping (180 dia reel)	1kp(E12)	1kp(E12)	0.5kp(E12)	0.5kp(E12)
Taping (330 dia reel)	—	—	—	—

Note : P8 = 8mm width paper tape
E8 = 8mm width plastic tape
E12 = 12mm width plastic tape
* Carrier tape 2mm pitch from one capacitor to another.

Capacitance-Temperature
(temperature compensation)

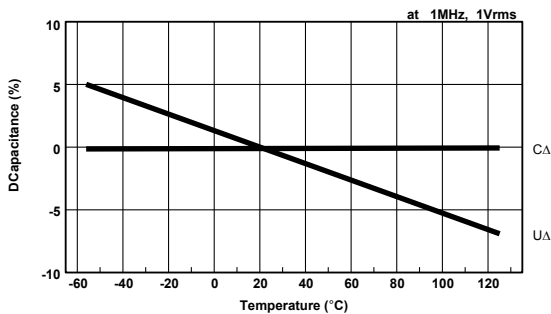

Aging
(change of capacitance over time)

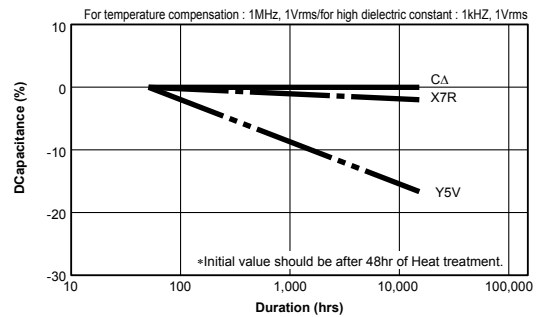

Capacitance-Temperature
(high dielectric constant)

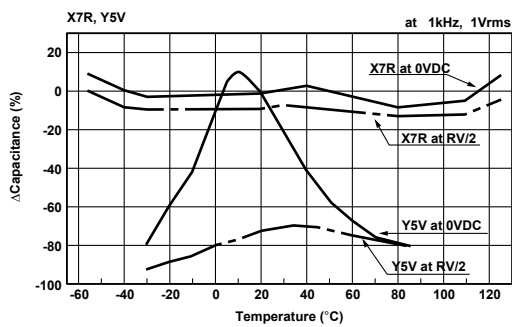

Impedance-Frequency

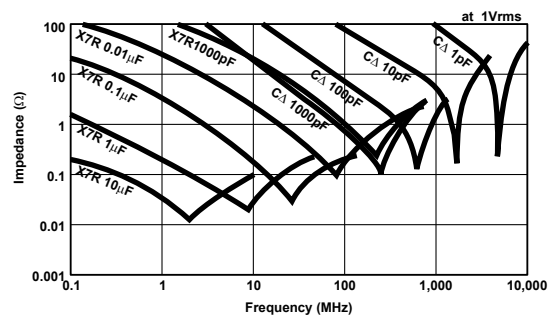

DC Bias

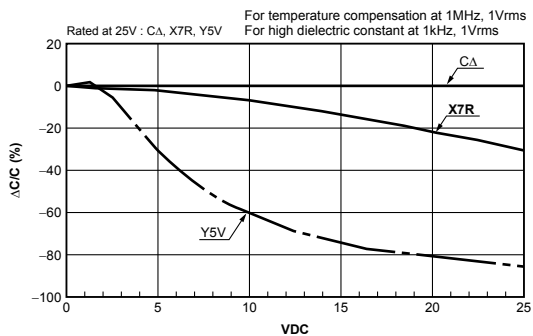

AC Voltage

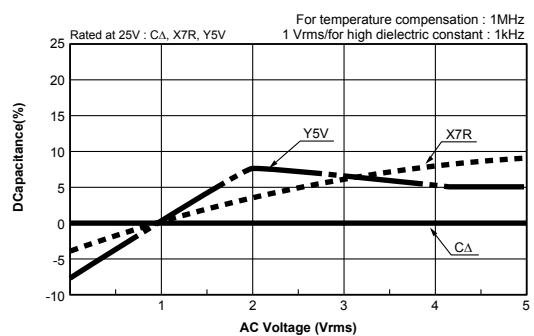

Please verify individual characteristics at the design stage to ensure total suitability



Test Conditions and Specification for Temperature Compensation type (C Δ to U Δ • SL Characteristics)

Test Items		Specification (C: nominal capacitance)	Test Conditions										
Capacitance Value		Within tolerance	<table border="1"> <tr> <td>C\leq1000pF</td> <td>1MHz\pm10%</td> <td>0.5 to</td> </tr> <tr> <td>C$>$1000pF</td> <td>1kHz\pm10%</td> <td>5Vrms</td> </tr> </table>			C \leq 1000pF	1MHz \pm 10%	0.5 to	C $>$ 1000pF	1kHz \pm 10%	5Vrms		
C \leq 1000pF	1MHz \pm 10%	0.5 to											
C $>$ 1000pF	1kHz \pm 10%	5Vrms											
Q		C \geq 30pF: Q \geq 1000 C $<$ 30pF: Q \geq 400+20C											
Insulation resistance (IR) (*5)		10,000M Ω or 500M Ω • μ F min., whichever is less	Measured after the rated voltage is applied for one minute at normal room temperature and humidity. (*3)										
Dielectric Resistance (*5)		No problem observed	(*1) Apply 3 times of the rated voltage for 1 to 5 seconds.										
Appearance		No problem observed	Microscope (10 \times magnification)										
Termination strength		No problem observed	Apply a sideward force of 500g(5N) (*2) to a PCB-mounted sample.										
Bending strength		No mechanical damage at 1mm bent	Glass epoxy PCB (t=1.6mm); fulcrum Spacing: 90mm; for 10 seconds.										
Vibration test	Appearance	No significant change is detected	Vibration frequency: 10 to 55(Hz) Amplitude: 1.5mm Sweeping condition: 10 \rightarrow 55 \rightarrow 10Hz/min In X, Y and Z directions: 2 hours each Total 6 hours										
	Δ C	Within tolerance											
	Q	C \geq 30pF: Q \geq 1000 C $<$ 30pF: Q \geq 400+20C											
Soldering heat resistance	Appearance	No significant change is detected	Soak the sample in 260°C \pm 5°C solder for 10 \pm 0.5seconds and place in a room at normal temperature and humidity; measure after 24 \pm 2hours. (Preheating Conditions)										
	Δ C	\pm 2.5% or \pm 0.25pF max., whichever is larger											
	Q	C \geq 30pF: Q \geq 1000 C $<$ 30pF: Q \geq 400+20C											
	IR (*5)	10,000M Ω or 500M Ω • μ F min., whichever is smaller											
	Withstand voltage (*5)	Resists without problem	<table border="1"> <thead> <tr> <th>Order</th> <th>Temperature</th> <th>Time</th> </tr> </thead> <tbody> <tr> <td>1</td> <td>80 to 100°C</td> <td>2minutes</td> </tr> <tr> <td>2</td> <td>150 to 200°C</td> <td>2minutes</td> </tr> </tbody> </table>			Order	Temperature	Time	1	80 to 100°C	2minutes	2	150 to 200°C
Order	Temperature	Time											
1	80 to 100°C	2minutes											
2	150 to 200°C	2minutes											
Solderability		Ni/Br termination: 90% min.	Soaking Condition										
			<table border="1"> <tbody> <tr> <td>Sn63 Solder</td> <td>235\pm5°C</td> <td>2\pm0.5sec.</td> </tr> <tr> <td>Sn-3Ag-0.5Cu</td> <td>245\pm5°C</td> <td>3\pm0.5sec.</td> </tr> </tbody> </table>			Sn63 Solder	235 \pm 5°C	2 \pm 0.5sec.	Sn-3Ag-0.5Cu	245 \pm 5°C	3 \pm 0.5sec.		
Sn63 Solder	235 \pm 5°C	2 \pm 0.5sec.											
Sn-3Ag-0.5Cu	245 \pm 5°C	3 \pm 0.5sec.											
Temperature cycle	Appearance	No significant change is detected	(Cycle) Normal room temperature (3min.) \rightarrow Lowest operation temperature (30min.) \rightarrow Normal room temperature (3min.) \rightarrow Highest operation temperature (30min.) \rightarrow After five cycles, measure after 24 \pm 2hours.										
	Δ C	\pm 2.5% or \pm 0.25pF max., whichever is larger											
	Q	C \geq 30pF: Q \geq 1000 C $<$ 30pF: Q \geq 400+20C											
	IR (*5)	10,000M Ω or 500M Ω • μ F min., whichever is smaller											
	Withstand voltage (*5)	Resists without problem											
Load humidity test (*4)	Appearance	No significant change is detected	After applying rated voltage for 500+24/-0 hours in pre condition at 40 \pm 2°C, humidity 90 to 95%RH allow parts to stabilize for 48 \pm 4 hours, at room temperature before making measurements.										
	Δ C	\pm 7.5% or \pm 0.75pF max., whichever is larger											
	Q	C \geq 30pF: Q \geq 200 C $<$ 30pF: Q \geq 100+10C/3											
	IR (*5)	500M Ω or 25M Ω • μ F min., whichever is smaller											
High-temperature with loading	Appearance	No significant change is detected	After applying (*1) twice of the rated voltage at a temperature of 125 \pm 3°C for 1000+48/-0hours, measure the sample after storing 24 \pm 2hours.										
	Δ C	\pm 3% or \pm 0.3pF max., whichever is larger											
	Q	C \geq 30pF: Q \geq 350 10pF \leq C $<$ 30pF: Q \geq 275+5C/2 C $<$ 10pF: Q \geq 200+10C											
	IR (*5)	1,000M Ω or 50M Ω • μ F min., whichever is smaller											

*1 For the CF series, use 1.5 times when the rated voltage is 250V; use/1.2 times when the rated voltage exceeds 630V.

*2 2N at 0201 Size

*3 Apply 500V for 1minute in case the rated voltage is 1000V or higher.

*4 Except CF series.

*5 The charge and discharge current of the capacitor must not exceed 50mA.



Test Conditions and Specification for High Dielectric Type (X5R, X7R, Y5V)

Test Items		Specification		Test Condition											
		X7R/X5R	Y5V												
Capacitance Value		Within tolerance		Do previous treatment (*8, *14)											
tanδ (%)		2.5%max., 3.5%max. (*2), 7.0%max. (*12) 5.0%max. (*3), 7.5%max. (*17)		5.0%max., 7.0%max. (*13) 9.0%max. (*4), 12.5%max. (*5)		<table border="1"> <thead> <tr> <th>Capacitance</th> <th>Fire</th> <th>Vol</th> </tr> </thead> <tbody> <tr> <td>C≤10μF</td> <td>1kHz±10%</td> <td>1.0±0.1Vrms</td> </tr> <tr> <td>C>10μF</td> <td>120Hz±10%</td> <td>0.5±0.1Vrms</td> </tr> </tbody> </table>	Capacitance	Fire	Vol	C≤10μF	1kHz±10%	1.0±0.1Vrms	C>10μF	120Hz±10%	0.5±0.1Vrms
		Capacitance	Fire	Vol											
C≤10μF	1kHz±10%	1.0±0.1Vrms													
C>10μF	120Hz±10%	0.5±0.1Vrms													
Insulation resistance (IR) (*15)		10,000MΩ or 500MΩ•μF min., whichever is less		Measured after the rated voltage is applied for 2minutes at normal room temperature and humidity. (*10)											
Dielectric Resistance (*15)		No problem observed		(*1) Apply 2.5 times of the rated voltage for 1 to 5 seconds.											
Appearance		No problem observed		Microscope (10×magnification)											
Termination strength (*6)		No problem observed		Apply a sideward force of 500g(5N) (*16) to a PCB-mounted sample.											
Bending strength test (*6)		No problem observed at 1mm bent		Glass epoxy PCB (*03,05 type and CA Series: T=0.8mm); fulcrum Spacing: 90mm; for 10 seconds.											
Vibration test	Appearance	No significant change is detected		Vibration frequency: 10 to 55(Hz) Amplitude: 1.5mm Sweeping condition: 10→55→10Hz/min In X, Y and Z directions: 2 hours each Total 6 hours											
	ΔC	Within tolerance													
	tanδ (%)	Satisfies the initial value													
Soldering heat resistance	Appearance	No significant change is detected		Do previous treatment (*8) Soak the sample in 260°C±5°C solder for 10±0.5seconds and place in a room at normal temperature and humidity; measure after 48±4hours. (Preheating Conditions)											
	ΔC	Within ±7.5%	Within ±20%												
	tanδ (%)	Satisfies the initial value													
	IR (*15)	10,000MΩ or 500MΩ•μF min., whichever is smaller													
	Withstand voltage (*15)	Resists without problem													
Solderability		Ni/Br termination: 90% min.		Soaking Condition											
				<table border="1"> <thead> <tr> <th>Order</th> <th>Temperature</th> <th>Time</th> </tr> </thead> <tbody> <tr> <td>1</td> <td>80 to 100°C</td> <td>2minutes</td> </tr> <tr> <td>2</td> <td>150 to 200°C</td> <td>2minutes</td> </tr> </tbody> </table>			Order	Temperature	Time	1	80 to 100°C	2minutes	2	150 to 200°C	2minutes
Order	Temperature	Time													
1	80 to 100°C	2minutes													
2	150 to 200°C	2minutes													
Temperature cycle	Appearance	No significant change is detected		Do previous treatment (*8) (Cycle) Normal room temperature (3min.)→ Lowest operation temperature (30min.)→ Normal room temperature (3min.)→ Highest operation temperature (30min.)→ After five cycles, measure after 48±4hours.											
	ΔC	Within ±7.5%	Within ±20%												
	tanδ (%)	Satisfies the initial value													
	IR (*15)	10,000MΩ or 500MΩ•μF min., whichever is smaller													
	Withstand voltage (*15)	Resists without problem													
Load humidity test (*11)	Appearance	No significant change is detected		Do previous treatment (*9) After applying rated voltage at 40±2°C and humidity 90 to 95%RH, for 500+24/-0 hours and keep at room condition for 48±4 hours then measure and check the specification limites.											
	ΔC	Within ±12.5%	Within ±30%												
	tanδ (%)	200% max. of initial value	150% max. of initial value												
	IR (*15)	500MΩ or 25MΩ•μF min., whichever is smaller													
High-temperature with loading	Appearance	No significant change is detected		Do previous treatment (*9) After applying twice (*7) of the rated voltage at the highest operating temperature for 1000+48/-0hours, measure the sample after storing 48±4hours.											
	ΔC	Within ±12.5%	Within ±30%												
	tanδ (%)	200% max. of initial value	150% max. of initial value												
	IR (*15)	1,000MΩ or 50MΩ•μF min., whichever is smaller													

*1 Use 1.5 times when the rated voltage is 250V or over.
Use 1.2 times when the rated voltage is 630V or over.
*2 X7R 16V/25V type.
*3 Apply to X5R16V/25V type, X7R 6.3V/10V type.
*4 Apply to Y5V 16V type, CM32Y5V335 to 106 (25V Type).
*5 Apply to Y5V 6.3V/10V type. Apply 16% to CM21Y5V106/CM316Y5V226.
*6 Exclude CT series with thickness of less than 0.66mm and CA series.
*7 Use 1.5times when the rated voltage is 4V/6.3V/10V/250V and 100V (32X7R474/43X7R105/55X7R105).
Use 1.2times when the rated voltage is 630V or over.
*8 Keep specimen at 150°C+0/-10°C for one hour, leave specimen at room ambient for 48±4 hours.
*9 Apply the same test condition for one hour, then leave the specimen at room ambient for 48±4 hours.
*10 For the CF series over 630V, apply 500V for 1 minutes at room ambient.
*11 Except CF series.
*12 Apply to X5R 10V type.
*13 Apply to 25V series of CM105Y5V154 over, CM21Y5V105 over, 316Y5V155 over.
*14 Measurement condition 1kHz, 1Vrms for Y5V, C < 47μF type.
*15 The charge/discharge current of the capacitor must not exceed 50mA.
*16 2N at 0201 Size
*17 Apply to X5R 4V and 6.3V type.

Tape and Reel

• Reel

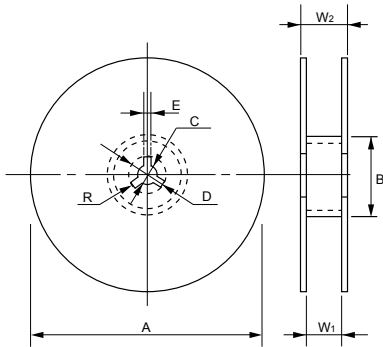

F=2mm (03, 05, 105 Type)

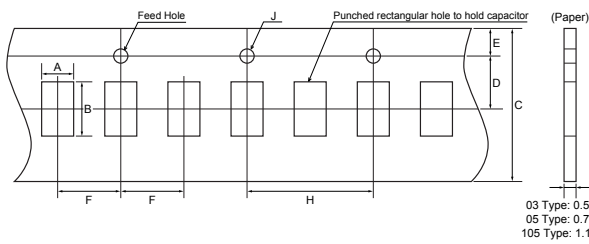

F=4mm (105, D11, D12, F12, 21, 316, 32, 42, 52 Type)

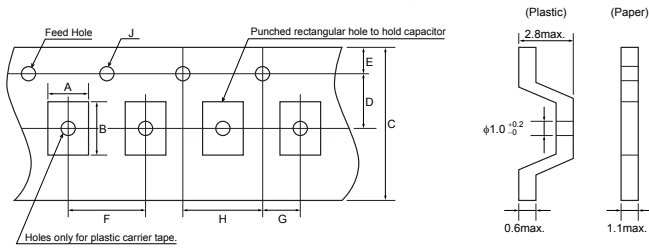

F=8mm (43, 53, 55 Type)

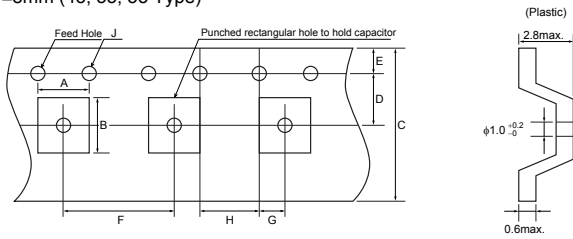

Bulk Cassette (Unit : mm)

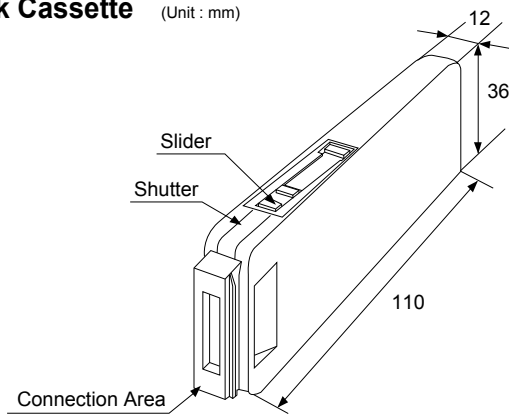

Reel

(Unit : mm)

Code Reel	A	B	C	D
7-inch Reel (CODE : T, H)	180 ⁺⁰ _{-0.2}	φ60min.	13±0.5	21±0.8
13-inch Reel (CODE : L, N)	330±2.0	φ100±1.0		
Code Reel	E	W ₁	W ₂	R
7-inch Reel (CODE : T, H)	2.0±0.5	10.0±1.5	16.5max.	1.0
13-inch Reel (CODE : L, N)		9.5±1.0		

*Carrier tape width 8mm. For size 42(1808) or over, Tape width 12mm and W₁ : 14±1.5, W₂ : 18.4mm max.

Carrier Tape

(Unit : mm)

Type	A	B	F
03 (0.6×0.3)	0.37±0.03	0.67±0.03	2.0±0.05
05 (1.0×0.5)	0.65±0.1	1.15±0.1	2.0±0.05
105 (1.6×0.8)	1.0±0.2	1.8±0.2	4.0±0.1
D11 (1.37×1.0)	1.15±0.1	1.55±0.1	4.0±0.1
D12 (1.25×2.0)	1.5±0.2	2.3±0.2	4.0±0.1
F12 (1.25×2.0)	1.5±0.2	2.3±0.2	4.0±0.1
21 (2.0×1.25)	1.5±0.2	2.3±0.2	4.0±0.1
316 (3.2×1.6)	2.0±0.2	3.6±0.2	4.0±0.1
32 (3.2×2.5)	2.9±0.2	3.6±0.2	4.0±0.1
42 (4.5×2.0)	2.4±0.2	4.9±0.2	4.0±0.1
43 (4.5×3.2)	3.6±0.2	4.9±0.2	8.0±0.1
52 (5.7×2.0)	2.4±0.2	6.0±0.2	4.0±0.1
53 (5.7×2.8)	3.2±0.2	6.0±0.2	8.0±0.1
55 (5.7×5.0)	5.3±0.2	6.0±0.2	8.0±0.1

(Unit : mm)

F	Carrier Tape	C	D	E	G	H	J
2.0 ±0.05	8mm Paper	8.0 ±0.3	3.5 ±0.05	1.75 ±0.1	2.0 ±0.05	4.0 ±0.1	1.5 ±0.1/-0
4.0 ±0.1	8mm Plastic						
8.0 ±0.1	12mm Plastic	12.0 ±0.3	5.5 ±0.05				



Circuit Design

1. Once application and assembly environments have been checked, the capacitor may be used in conformance with the rating and performance which are provided in both the catalog and the specifications. Use exceeding that which is specified may result in inferior performance or cause a short, open, smoking, or flaming to occur, etc.
2. Please consult the manufacturer in advance when the capacitor is used in devices such as: devices which deal with human life, i.e. medical devices; devices which are highly public orientated; and devices which demand a high standard of liability.
Accident or malfunction of devices such as medical devices, space equipment and devices having to do with atomic power could generate grave consequence with respect to human lives or, possibly, a portion of the public. Capacitors used in these devices may require high reliability design different from that of general purpose capacitors.
3. Please use the capacitors in conformance with the operating temperature provided in both the catalog and the specifications.
Be especially cautious not to exceed the maximum temperature. In the situation the maximum temperature set forth in both the catalog and specifications is exceeded, the capacitor's insulation resistance may deteriorate, power may suddenly surge and short-circuit may occur. The capacitor has a loss, and may self-heat due to equivalent series resistance when alternating electric current is passed therethrough. As this effect becomes especially pronounced in high frequency circuits, please exercise caution.
When using the capacitor in a (self-heating) circuit, please make sure the surface of the capacitor remains under the maximum temperature for usage. Also, please make certain temperature rises remain below 20°C.
4. Please keep voltage under the rated voltage which is applied to the capacitor. Also, please make certain the peak voltage remains below the rated voltage when AC voltage is super-imposed to the DC voltage.
In the situation where AC or pulse voltage is employed, ensure average peak voltage does not exceed the rated voltage.
Exceeding the rated voltage provided in both catalog and specifications may lead to defective withstanding voltage or, in worst case situations, may cause the capacitor to smoke or flame.
5. When the capacitor is to be employed in a circuit in which there is continuous application of a high frequency voltage or a steep pulse voltage, even though it is within the rated voltage, please inquire to the manufacturer.
In the situation the capacitor is to be employed using a high frequency AC voltage or a extremely fast rising pulse voltage, even though it is within the rated voltage, it is possible capacitor reliability will deteriorate.
6. It is a common phenomenon of high-dielectric products to have a deteriorated amount of static electricity due to the application of DC voltage.
Due caution is necessary as the degree of deterioration varies depending on the quality of capacitor materials, capacity, as well as the load voltage at the time of operation.
7. Do not use the capacitor in an environment where it might easily exceed the respective provisions concerning shock and vibration specified in the catalog and specifications.
In addition, it is a common piezo phenomenon of high dielectric products to have some Voltage due to vibration or to have noise due to Voltage change. Please contact sales in such case.
8. If the electrostatic capacity value of the delivered capacitor is within the specified tolerance, please consider this when designing the respective product in order that the assembled product function appropriately.
9. Please contact us upon using conductive adhesives.

Storage

1. If the component is stored in minimal packaging (a heat-sealed or chuck-type plastic bag), the bag should be kept closed. Once the bag has been opened, reseal it or store it in a desiccator.
2. Keep storage place temperature +5 to +35 degree C, humidity 45 to 70% RH.
3. The storage atmosphere must be free of gas containing sulfur and chlorine. Also, avoid exposing the product to saline moisture. If the product is exposed to such atmospheres, the terminals will oxidize and solderability will be effected.
4. Precautions 1)-3) apply to chip capacitors packaged in carrier tapes and bulk cases.
5. The solderability is assured for 12 months from our shipping date (six months for silver palladium) if the above storage precautions are followed.
6. Chip capacitors may crack if exposed to hydrogen (H₂) gas while sealed or if coated with silicon, which generates hydrogen gas.

Dimensions for recommended typical land

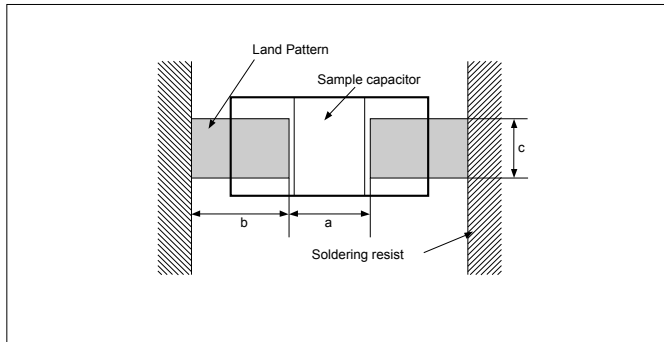

When mounting the capacitor to the substrate, it is important to consider carefully that the amount of solder (size of fillet) used has a direct effect upon the capacitor once it is mounted.

- a) The greater the amount of solder, the greater the stress to the elements. As this may cause the substrate to break or crack, it is important to establish the appropriate dimensions with regard to the amount of solder when designing the land of the substrate.
- b) In the situation where two or more devices are mounted onto a common land, separate the device into exclusive pads by using soldering resist

Standard

(Unit : mm)

Size	L×W	a	b	c
03	0.6×0.3	0.20 to 0.30	0.25 to 0.35	0.30 to 0.40
05	1.0×0.5	0.30 to 0.50	0.35 to 0.45	0.40 to 0.60
105	1.6×0.8	0.70 to 1.00	0.80 to 1.00	0.60 to 0.80
21	2.0×1.25	1.00 to 1.30	1.00 to 1.20	0.80 to 1.10
316	3.2×1.6	2.10 to 2.50	1.10 to 1.30	1.00 to 1.30
32	3.2×2.5	2.10 to 2.50	1.10 to 1.30	1.90 to 2.30
42	4.5×2.0	2.50 to 3.20	1.80 to 2.30	1.50 to 1.80
43	4.5×3.2	2.50 to 3.20	1.80 to 2.30	2.60 to 3.00
52	5.7×2.0	4.20 to 4.70	2.00 to 2.50	1.50 to 1.80
53	5.7×2.8	4.20 to 4.70	2.00 to 2.50	2.20 to 2.60
55	5.7×5.0	4.20 to 4.70	2.00 to 2.50	4.20 to 4.70

* CA series : Please refer applicable page.

Automotive Series

(Unit : mm)

Size	L×W	a	b	c
105	1.6×0.8	0.60 to 0.90	0.80 to 1.00	0.70 to 1.00
21	2.0×1.25	0.90 to 1.20	0.80 to 1.20	0.90 to 1.40
316	3.2×1.6	1.40 to 1.90	1.00 to 1.30	1.30 to 1.80

Ideal Solder Thickness

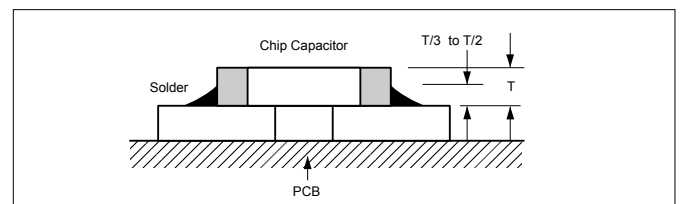

Typical mounting problems

Item	Not recommended example	Recommended example/Separated by solder
Multiple parts mount		
Mount with leaded parts		
Wire soldering after mounting		
Overview		

Mounting Design

The chip could crack if the PCB warps during processing after the chip has been soldered.

Recommended chip position on PCB to minimize stress from PCB warpage



Actual Mounting

- 1) If the position of the vacuum nozzle is too low, a large force may be applied to the chip capacitor during mounting, resulting in cracking.
- 2) During mounting, set the nozzle pressure to a static load of 100 to 300 gf.
- 3) To minimize the shock of the vacuum nozzle, provide a support pin on the back of the PCB to minimize PCB flexure.



- 4) Bottom position of pick up nozzle should be adjusted to the top surface of a substrate which camber is corrected.
- 5) To reduce the possibility of chipping and cracks, minimize vibration to chips stored in a bulk case.
- 6) The discharge pressure must be adjusted to the part size. Verify the pressure during setup to avoid fracturing or cracking the chips capacitors.

Resin Mold

- 1) If a large amount of resin is used for molding the chip, cracks may occur due to contraction stress during curing. To avoid such cracks, use a low shrinkage resin.
- 2) The insulation resistance of the chip will degrade due to moisture absorption. Use a low moisture absorption resin.
- 3) Check carefully that the resin does not generate a decomposition gas or reaction gas during the curing process or during normal storage. Such gases may crack the chip capacitor or damage the device itself.

Soldering Method

- 1) Ceramic is easily damaged by rapid heating or cooling. If some heat shock is unavoidable, preheat enough to limit the temperature difference (Delta T) to within 130 degree Celsius.
- 2) The product size 1.0×0.5mm to 3.2×1.6mm can be used in reflow and wave soldering, and the product size of over 3.2×2.5mm, 0.6×0.3mm, and capacitor arrays can be used in reflow.
Circuit shortage and smoking can be created by using capacitors which are used neglecting the above caution.
- 3) Please see our recommended soldering conditions.
Please contact us if you use lead free solder because the peak temperature of lead free is different from non-lead free.

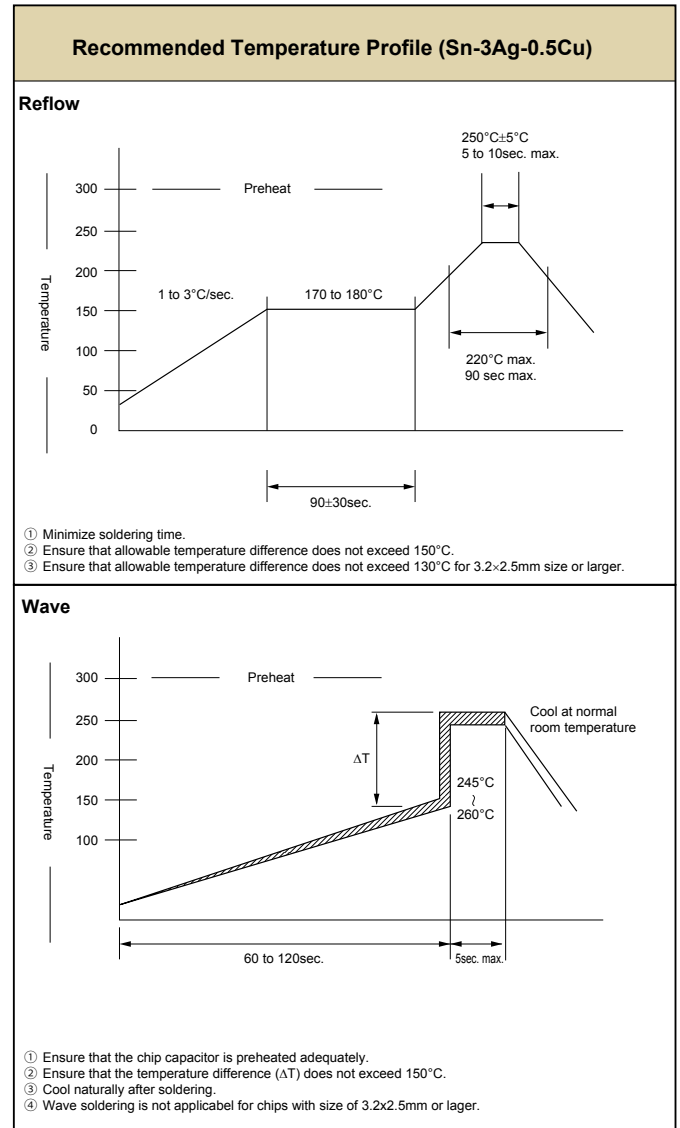
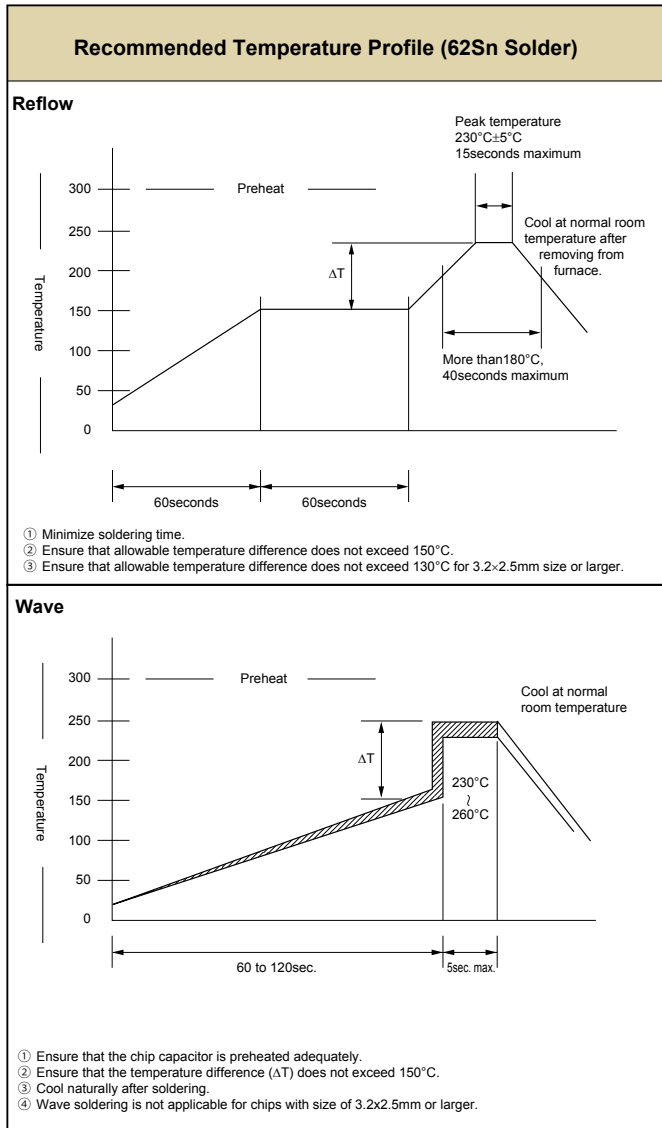

Soldering iron

- | | | |
|--------------------------------|-------------|--|
| 1) Temperature of iron chip | 380°C max. | 5) Cautions |
| 2) Wattage | 80W max. | a) Pre-heating is necessary Rapid heating must be avoided.
Delta T ≤ 150°C. |
| 3) Tip shape of soldering iron | φ3.0mm max. | b) Avoid direct touching to capacitors. |
| 4) Soldering Time | 3sec. max. | c) Avoid rapid cooling after soldering. Natural cooling is recommended. |