

DATA SHEET

GENERAL PURPOSE CHIP RESISTORS

RC0603 (Pb Free)
5%; 1%



Product specification – Aug 19, 2004 V.2



SCOPE

This specification describes RC0603 series chip resistors with lead-free terminations made by thick film process.

ORDERING INFORMATION

Part number is identified by the series, size, tolerance, packing type, temperature coefficient, taping reel and resistance value.

YAGEO ORDERING CODE

CTC CODE

RC0603 X X X XX XXXX L
 (1) (2) (3) (4) (5) (6)

ORDERING EXAMPLE

The ordering code of a RC0603 chip resistor, value 56 Ω with ±1% tolerance, supplied in 7-inch tape reel is: RC0603FR-0756RL.

(1) TOLERANCE

- F = ±1%
- J = ±5%

(2) PACKAGING TYPE

R = Paper/PE taping reel

(3) TEMPERATURE COEFFICIENT OF RESISTANCE

– = Base on spec

(4) TAPING REEL

- 07 = 7 inch dia. Reel
- 10 = 10 inch dia. Reel (not preferred)
- 13 = 13 inch dia. Reel

(5) RESISTANCE VALUE

5R6, 56R, 560R, 5K6, 56K, 22M.

(6) RESISTOR TERMINATIONS

L = Lead free terminations (pure Tin)

NOTE

1. The “L” at the end of the code is only for ordering. On the reel label, the standard CTC will be mentioned an additional stamp “LFP”= lead free production.
2. Products with lead in terminations fulfil the same requirements as mentioned in this datasheet.
3. Products with lead in terminations will be phased out in the coming months (before July 1st, 2006)

MARKING

RC0603



E-24 series: 3 digits

First two digits for significant figure and 3rd digit for number of zeros

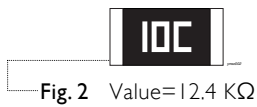

E-96 series: 3 digits for 0603 ±1% EIA-96 marking method

For 0603 ±1% E-24 series, one short bar under marking letter

For marking codes, please see EIA-marking code rules in data sheet “Chip resistors instruction”.

CONSTRUCTION

The resistors are constructed out of a high-grade ceramic body. Internal metal electrodes are added at each end and connected by a resistive paste. The composition of the paste is adjusted to give the approximate required resistance and laser cutting of this resistive layer that achieves tolerance trims the value. The resistive layer is covered with a protective coat and printed with the resistance value. Finally, the two external terminations (pure Tin) are added. See Fig. 4.

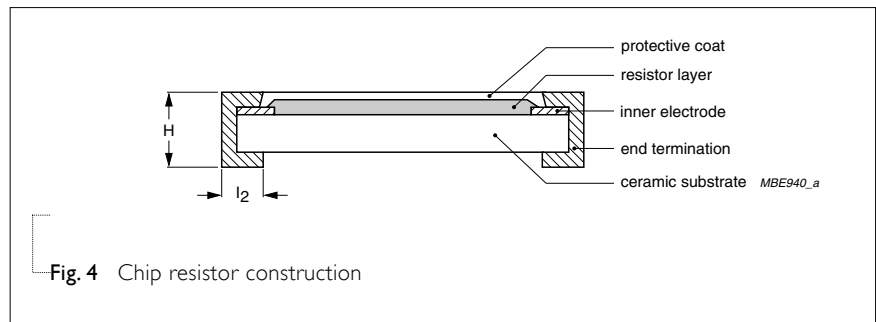

DIMENSIONS

Table I

TYPE	RC0603
L (mm)	1.60 ±0.1
W (mm)	0.80 ±0.10
H (mm)	0.45 ±0.10
l ₁ (mm)	0.25 ±0.15
l ₂ (mm)	0.25 ±0.15

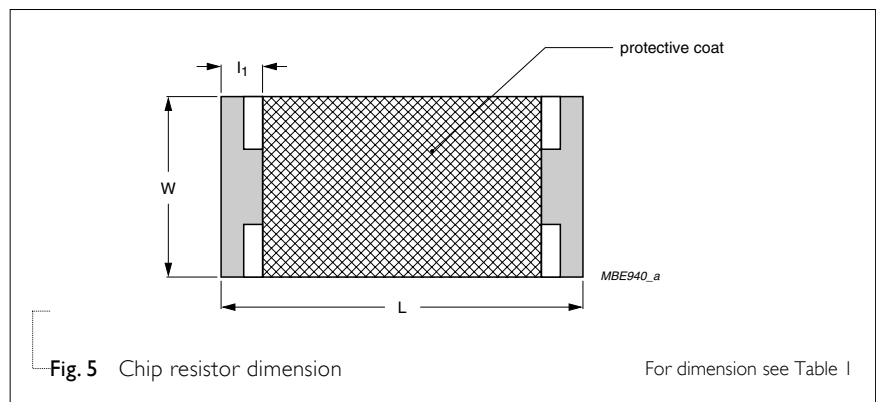

ELECTRICAL CHARACTERISTICS

Table 2

CHARACTERISTICS	RC0603 1/10 W
Operating Temperature Range	-55 °C to +155 °C
Maximum Working Voltage	50 V
Maximum Overload Voltage	100 V
Dielectric Withstanding Voltage	100 V
Resistance Range	5% (E24) 1 Ω to 22 MΩ
	1% (E96) 1 Ω to 10 MΩ
	Zero Ohm Jumper < 0.05 Ω
Temperature Coefficient	10 Ω < R ≤ 10 MΩ ±100 ppm/°C
	R ≤ 10 Ω; R > 10 MΩ ±200 ppm/°C
Jumper Criteria	Rated Current 1.0 A
	Maximum Current 2.0 A

FOOTPRINT AND SOLDERING PROFILES

For recommended footprint and soldering profiles, please see the special data sheet “Chip resistors mounting”.

ENVIRONMENTAL DATA

For material declaration information (IMDS-data) of the products, please see the separated info “Environmental data”.

PACKING STYLE AND PACKAGING QUANTITY

Table 3 Packing style and packaging quantity

PRODUCT TYPE	PACKING STYLE	REEL DIMENSION	QUANTITY PER REEL
RC0603	Paper / PE Taping Reel (R)	7" (178 mm)	5,000 units
		10" (254 mm) / not preferred	10,000 units
		13" (330 mm)	20,000 units

NOTE

1. For Paper/PE tape and reel specification/dimensions, please see the special data sheet “Packing” document.

FUNCTIONAL DESCRIPTION

POWER RATING

RC0603 rated power at 70°C is 1/10 W

RATED VOLTAGE

The DC or AC (rms) continuous working voltage corresponding to the rated power is determined by the following formula:

$$V = \sqrt{P \times R}$$

Where

V=Continuous rated DC or AC (rms) working voltage (V)

P=Rated power (W)

R=Resistance value (Ω)

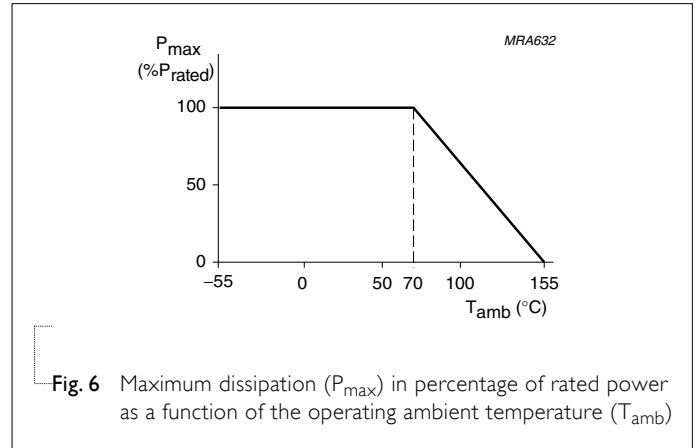

PULSE LOADING CAPABILITIES

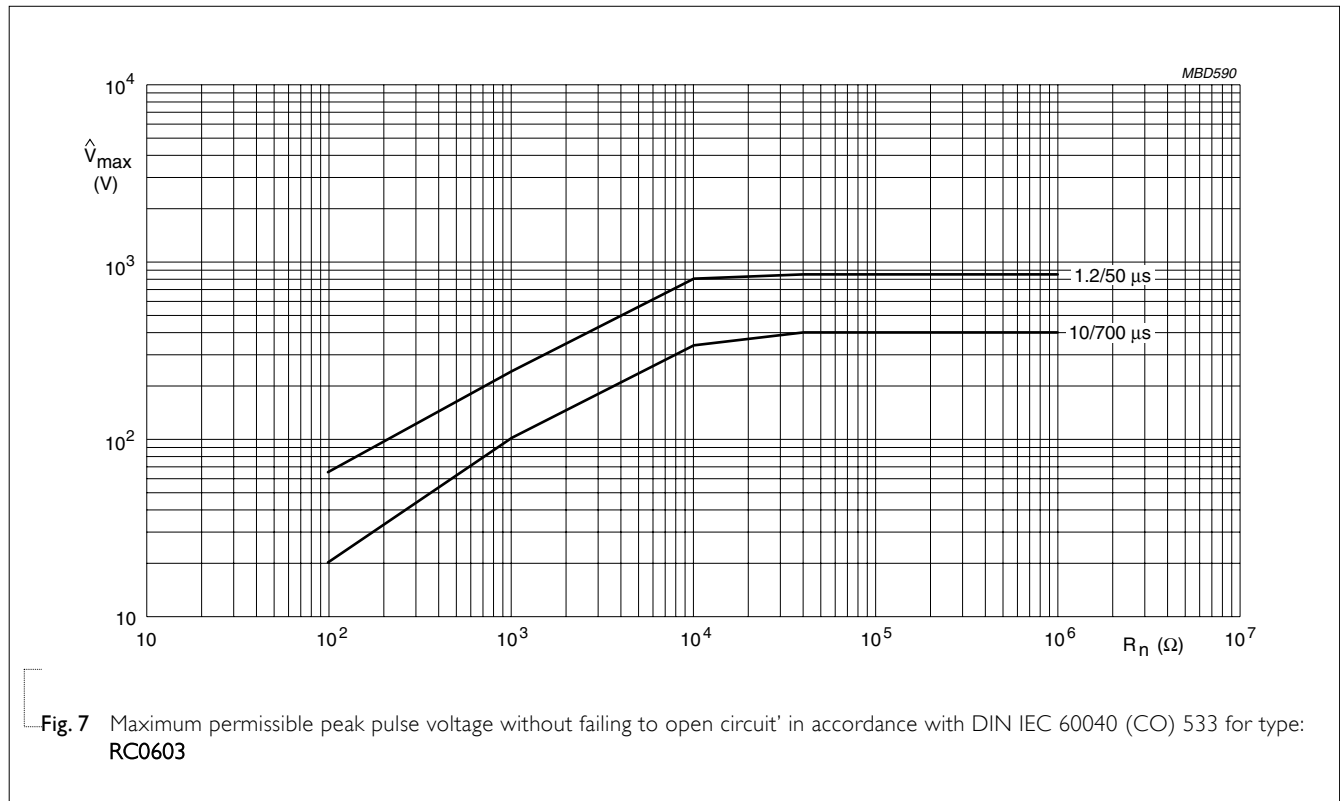

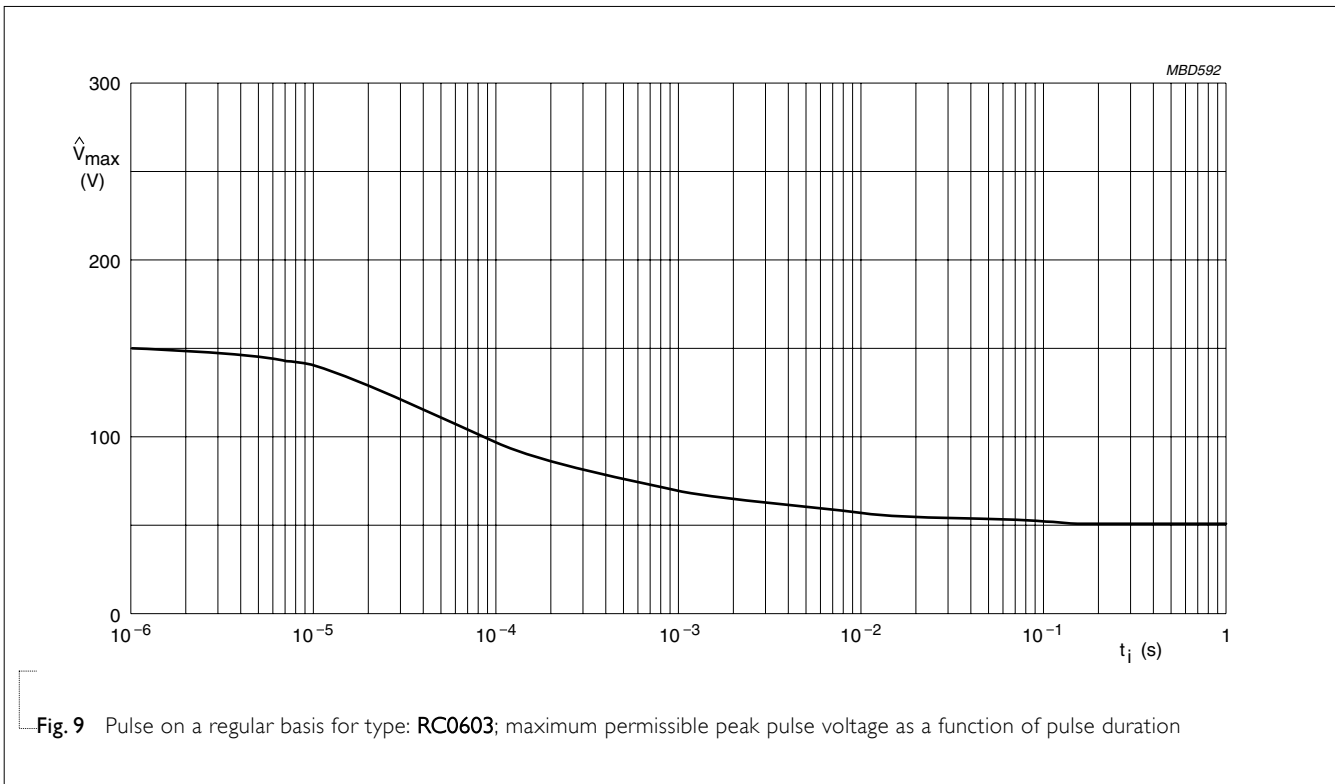
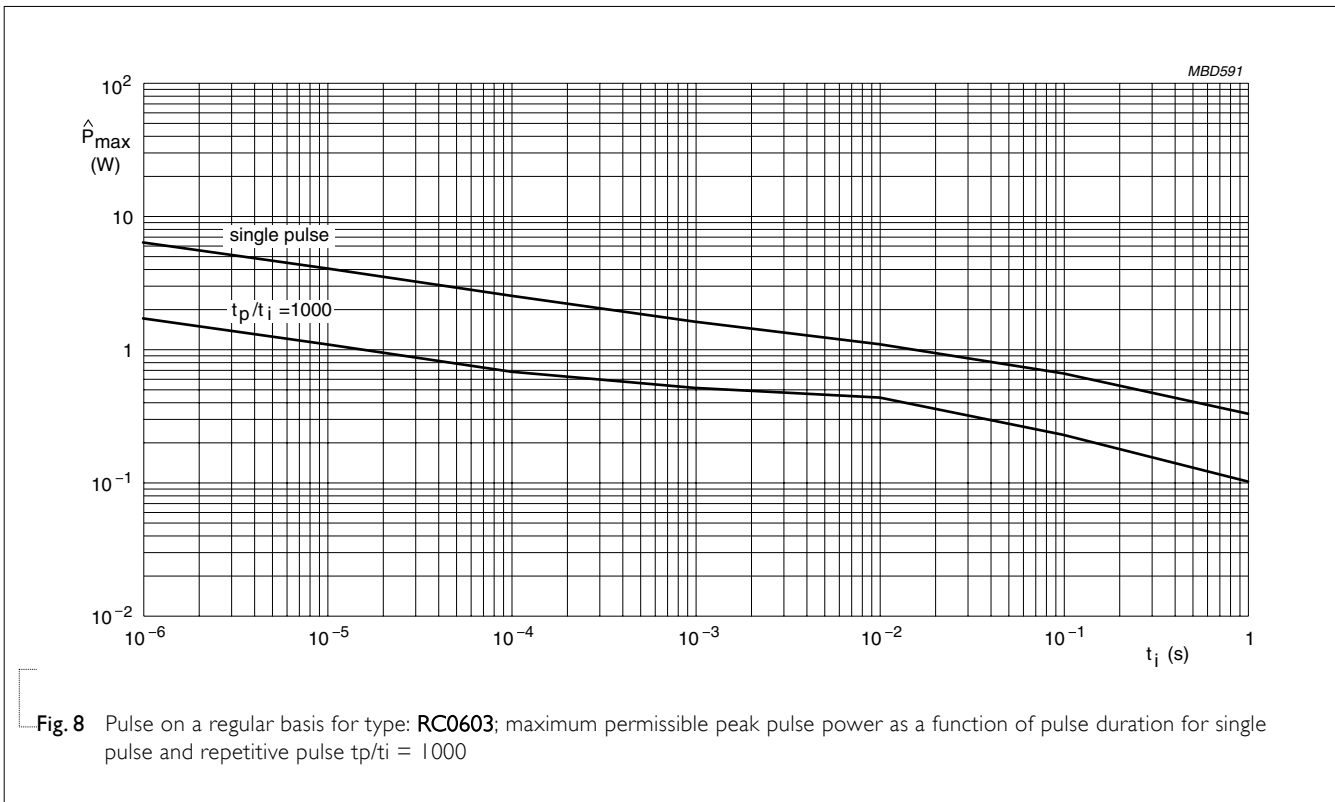

TESTS AND REQUIREMENTS

Table 4 Test condition, procedure and requirements

TEST	TEST METHOD	PROCEDURE	REQUIREMENTS
Temperature Coefficient of Resistance (T.C.R.)	MIL-STD-202F-method 304;	At +25/-55 °C and +25/+125 °C	Refer to table 2
	JIS C 5202-4.8	<p>Formula:</p> $T.C.R = \frac{R_2 - R_1}{R_1(t_2 - t_1)} \times 10^6 \text{ (ppm/°C)}$ <p>Where $t_1 = +25 \text{ °C}$ or specified room temperature $t_2 = -55 \text{ °C}$ or +125 °C test temperature $R_1 =$resistance at reference temperature in ohms $R_2 =$resistance at test temperature in ohms</p>	
Thermal Shock	MIL-STD-202F-method 107G; IEC 60115-1 4.19	At -65 (+0/-10) °C for 2 minutes and at +155 (+10/-0) °C for 2 minutes; 25 cycles	±(0.5%+0.05 Ω) for 1% tol. ±(1.0%+0.05 Ω) for 5% tol.
Low Temperature Operation	MIL-R-55342D-Para 4.7.4	At -65 (+0/-5) °C for 1 hour; RCWV applied for 45 (+5/-0) minutes	±(0.5%+0.05 Ω) for 1% tol . ±(1.0%+0.05 Ω) for 5% tol. No visible damage
Short Time Overload	MIL-R-55342D-Para 4.7.5; IEC 60115-1 4.13	2.5 × RCWV applied for 5 seconds at room temperature	±(1.0%+0.05 Ω) for 1% tol. ±(2.0%+0.05 Ω) for 5% tol. No visible damage
Insulation Resistance	MIL-STD-202F-method 302; IEC 60115-1 4.6.1.1	RCOV for 1 minute <u>Type</u> RC0603 <u>Voltage (DC)</u> 100 V	≥10 GΩ
Dielectric Withstand Voltage	MIL-STD-202F-method 301; IEC 60115-1 4.6.1.1	Maximun voltage (V_{rms}) applied for 1 minute <u>Type</u> RC0603 <u>Voltage (AC)</u> 100 V_{rms}	No breakdown or flashover
Resistance to Soldering Heat	MIL-STD-202F-method 210C; IEC 60115-1 4.18	Unmounted chips; 260 ±5 °C for 10 ±1 seconds	±(0.5%+0.05 Ω) for 1% tol. ±(1.0%+0.05 Ω) for 5% tol. No visible damage
Life	MIL-STD-202F-method 108A; IEC 60115-1 4.25.1	At 70±2 °C for 1,000 hours; RCWV applied for 1.5 hours on and 0.5 hour off	±(1%+0.05 Ω) for 1% tol. ±(3%+0.05 Ω) for 5% tol.

TEST	TEST METHOD	PROCEDURE	REQUIREMENTS														
Solderability	MIL-STD-202F-method 208A; IEC 60115-1 4.17	Solder bath at 245±3 °C Dipping time: 2±0.5 seconds	Well tinned (≥95% covered) No visible damage														
Bending Strength	JIS C 5202.6.14; IEC 60115-1 4.15	Resistors mounted on a 90 mm glass epoxy resin PCB (FR4) Bending: 5 mm	±(1.0%+0.05 Ω) for 1% tol. ±(1.0%+0.05 Ω) for 5% tol. No visible damage														
Resistance to Solvent	MIL-STD-202F-method 215; IEC 60115-1 4.29	Isopropylalcohol (C ₃ H ₇ OH) or dichloromethane (CH ₂ Cl ₂) followed by brushing	No smeared														
Noise	JIS C 5202 5.9; IEC 60115-1 4.12	Maximum voltage (V _{rms}) applied.	<table border="1"> <thead> <tr> <th>Resistors range</th> <th>Value</th> </tr> </thead> <tbody> <tr> <td>R < 100 Ω</td> <td>10 dB</td> </tr> <tr> <td>100 Ω ≤ R < 1 KΩ</td> <td>20 dB</td> </tr> <tr> <td>1 KΩ ≤ R < 10 KΩ</td> <td>30 dB</td> </tr> <tr> <td>10 KΩ ≤ R < 100 KΩ</td> <td>40 dB</td> </tr> <tr> <td>100 KΩ ≤ R < 1 MΩ</td> <td>46 dB</td> </tr> <tr> <td>1 MΩ ≤ R ≤ 22 MΩ</td> <td>48 dB</td> </tr> </tbody> </table>	Resistors range	Value	R < 100 Ω	10 dB	100 Ω ≤ R < 1 KΩ	20 dB	1 KΩ ≤ R < 10 KΩ	30 dB	10 KΩ ≤ R < 100 KΩ	40 dB	100 KΩ ≤ R < 1 MΩ	46 dB	1 MΩ ≤ R ≤ 22 MΩ	48 dB
Resistors range	Value																
R < 100 Ω	10 dB																
100 Ω ≤ R < 1 KΩ	20 dB																
1 KΩ ≤ R < 10 KΩ	30 dB																
10 KΩ ≤ R < 100 KΩ	40 dB																
100 KΩ ≤ R < 1 MΩ	46 dB																
1 MΩ ≤ R ≤ 22 MΩ	48 dB																
Humidity (steady state)	JIS C 5202 7.5; IEC 60115-8 4.24.8	1,000 hours; 40±2 °C; 93(+2/-3)% RH RCWV applied for 1.5 hours on and 0.5 hour off	±(0.5%+0.05 Ω) for 1% tol. ±(2.0%+0.05 Ω) for 5% tol.														
Leaching	EIA/IS 4.13B; IEC 60115-8 4.18	Solder bath at 260±5 °C Dipping time: 30±1 seconds	No visible damage														
Intermittent Overload	JIS C 5202 5.8	At room temperature; 2.5 × RCWV applied for 1 second on and 25 seconds off; total 10,000 cycles	±(1.0%+0.05 Ω) for 1% tol. ±(2.0%+0.05 Ω) for 5% tol.														
Resistance to Vibration	On request	On request															
Moisture Resistance Heat	MIL-STD-202F-method 106F; IEC 60115-1 4.24.2	42 cycles; total 1,000 hours Shown as Fig. 10	±(0.5%+0.05Ω) for 1% tol. ±(2.0%+0.05Ω) for 5% tol. No visible damage														

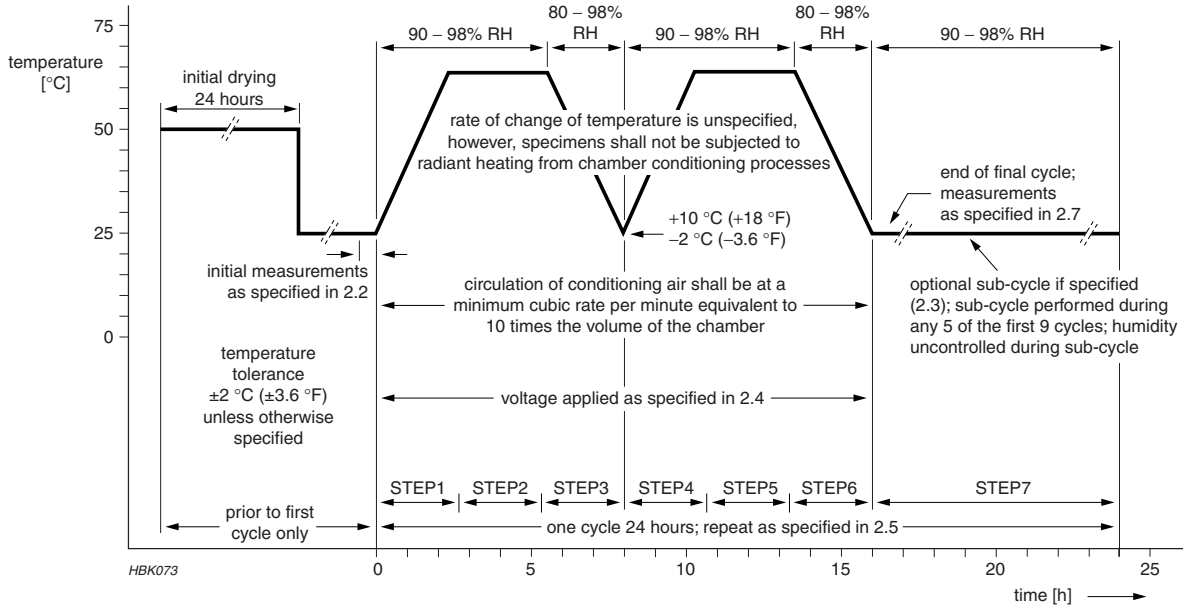

Fig. 10 Moisture resistance test requirements

REVISION HISTORY

REVISION	DATE	CHANGE NOTIFICATION	DESCRIPTION
Version 0	Nov. 07, 2003	-	- First issue of this specification
Version 1	Aug 02, 2004	-	- Test method and procedure updated - PE tape added (paper tape will be replaced by PE tape)
Version 2	Aug 19, 2004	-	-